















TOP PLAN

LEGEND

 Single bed with Night stand	 One-man wardrobe	 Conference table	 Transporter console
 Double washbasin	 Small desk	 Medical bed	
 Lounge chair	 Small bath/Jacuzzi unit	 Mess table	
 Desk	 Deluxe bath/Jacuzzi unit	 Turbo-elevator door	
 Chair	 Toilet		

This packet of plans was designed and drawn by FASA Corporation. P.O. Box 6930 Chicago, IL 60680



U.S.S. ENTERPRISE
 Constitution Class Heavy Cruiser
 Sheet 1 of 9 Side A

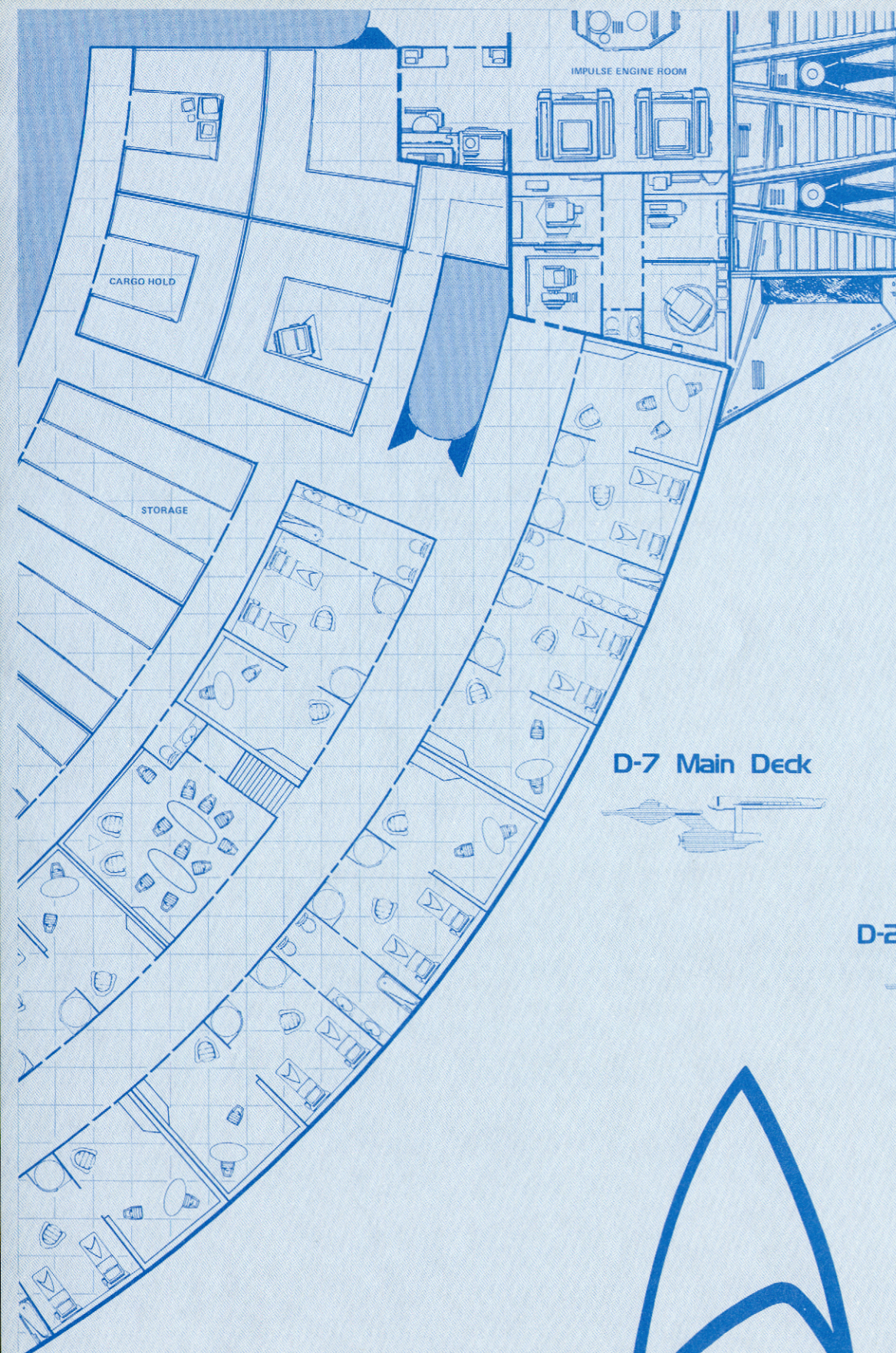

D-7 Main Deck



D-23 Cargo Storage

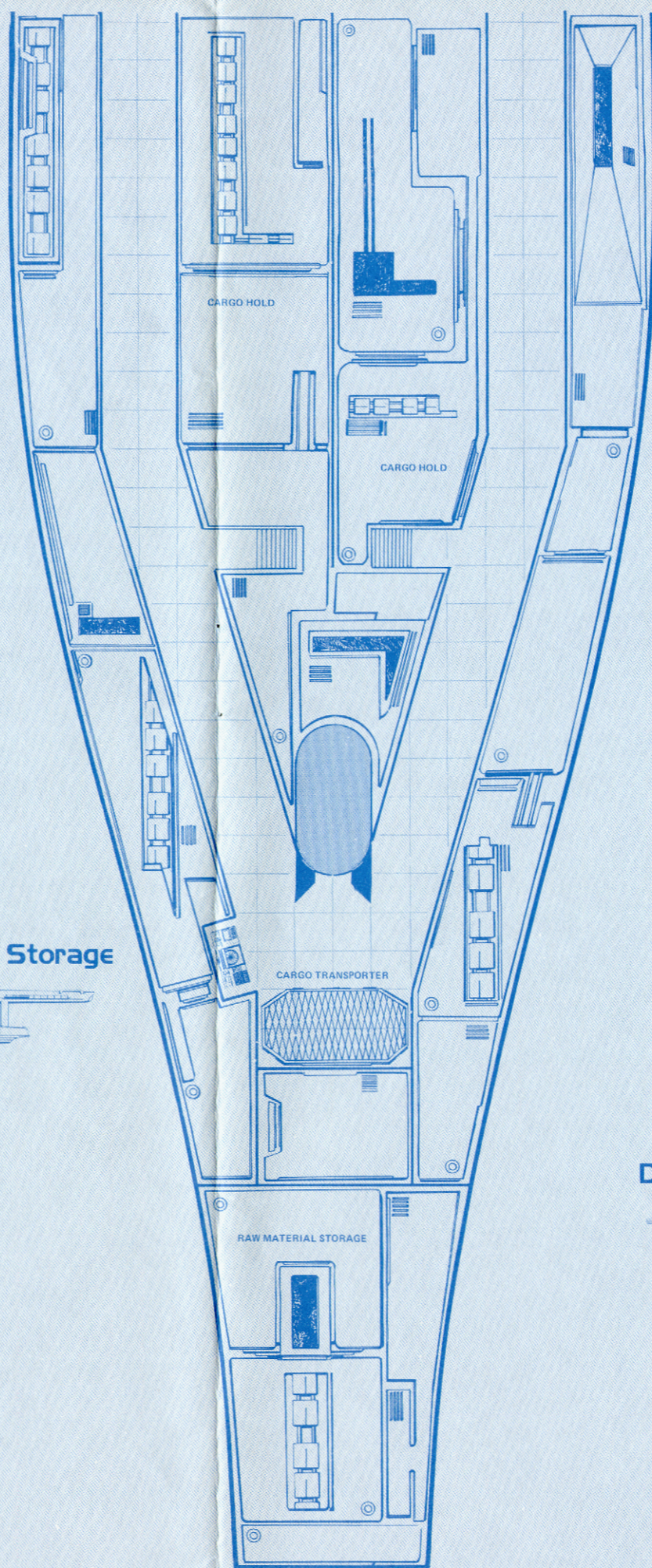

D-24 Hull Bottom

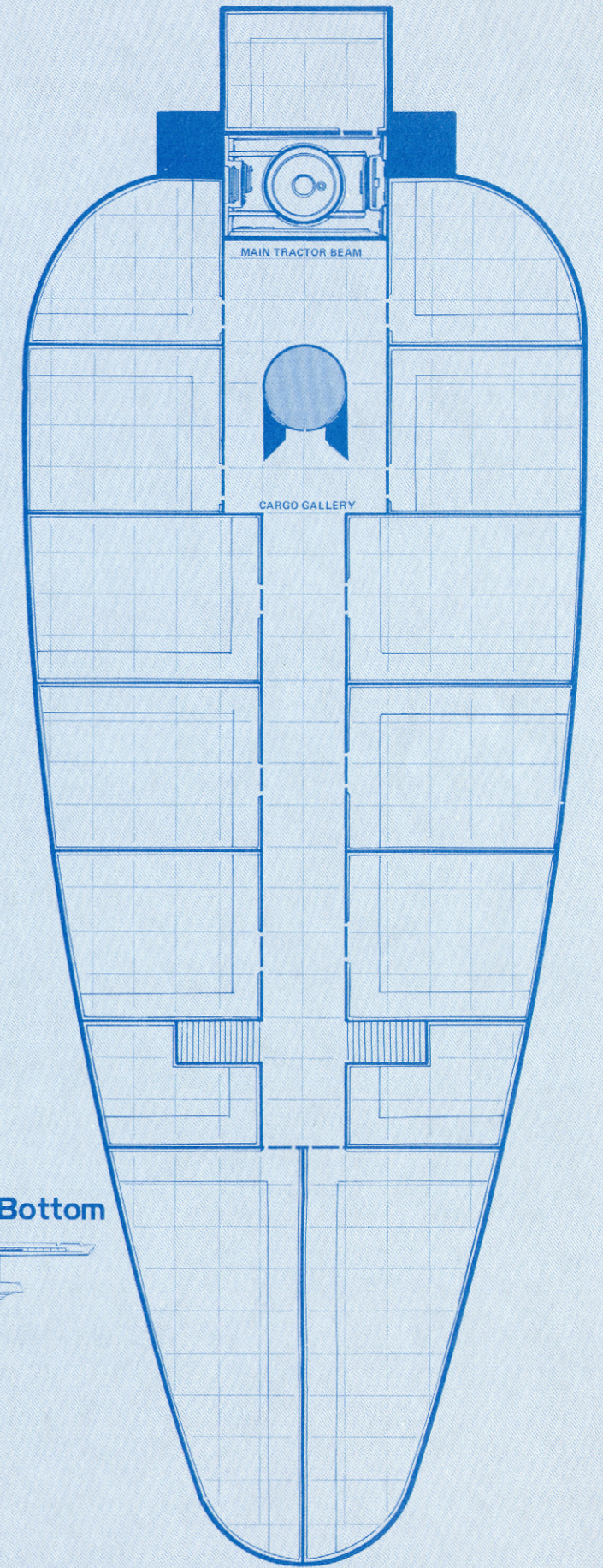

U.S.S. ENTERPRISE
 Constitution Class Heavy Cruiser
 Sheet 1 of 9 Side B

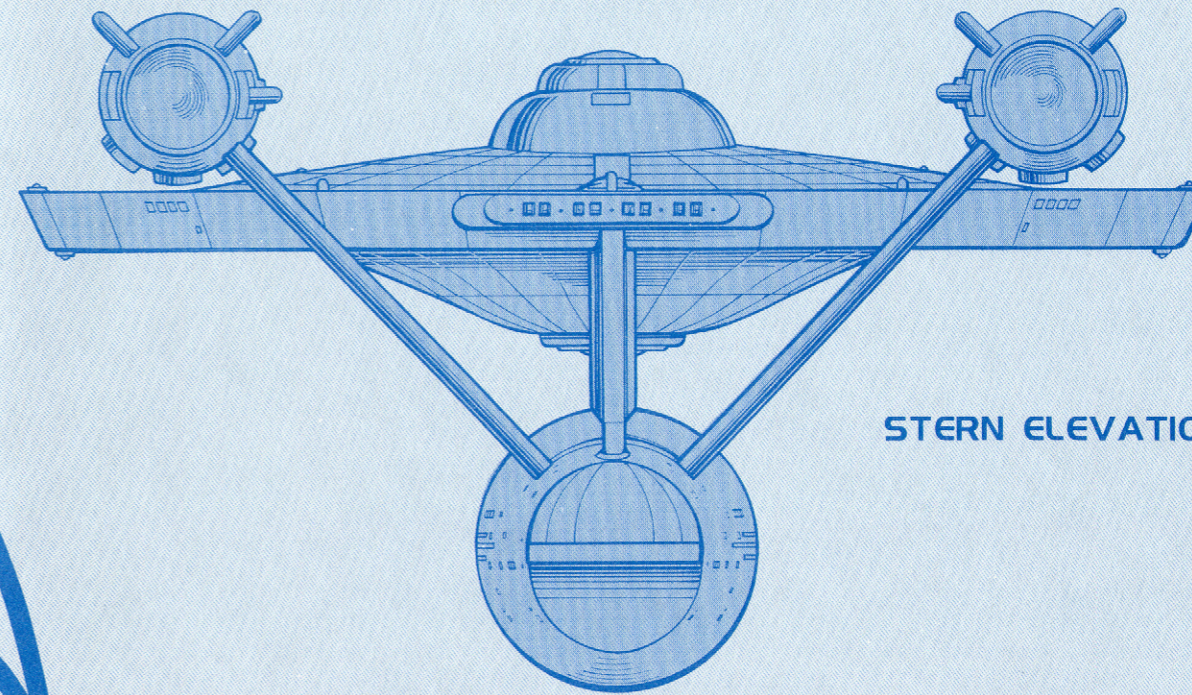
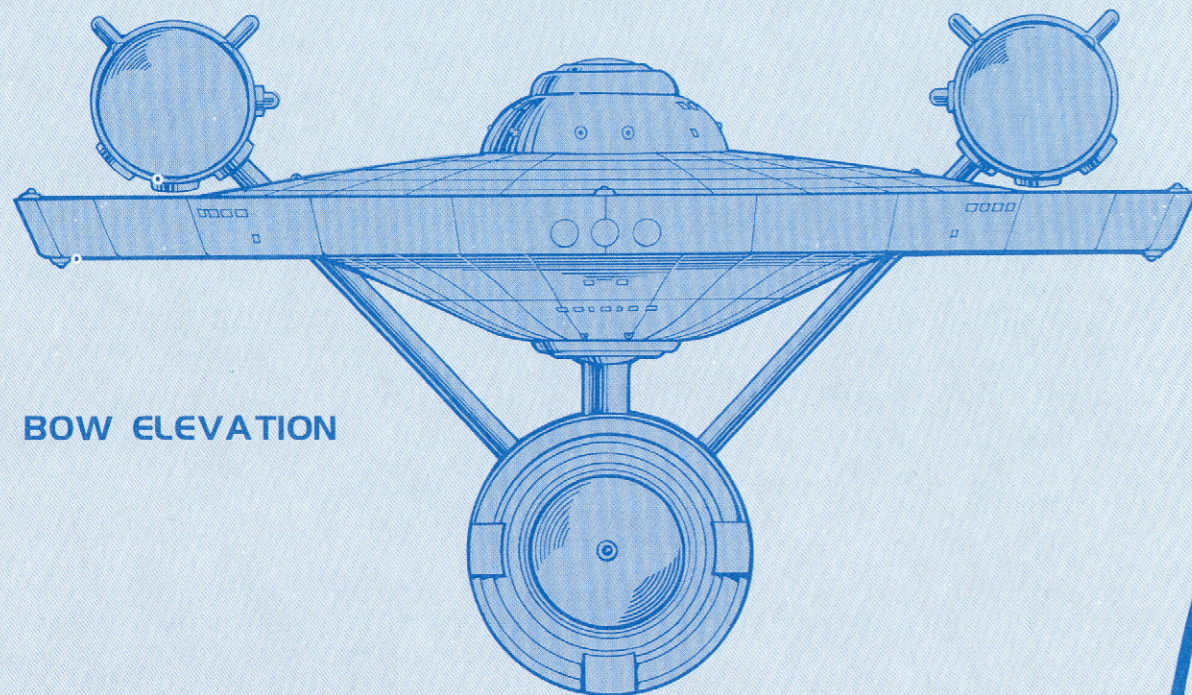
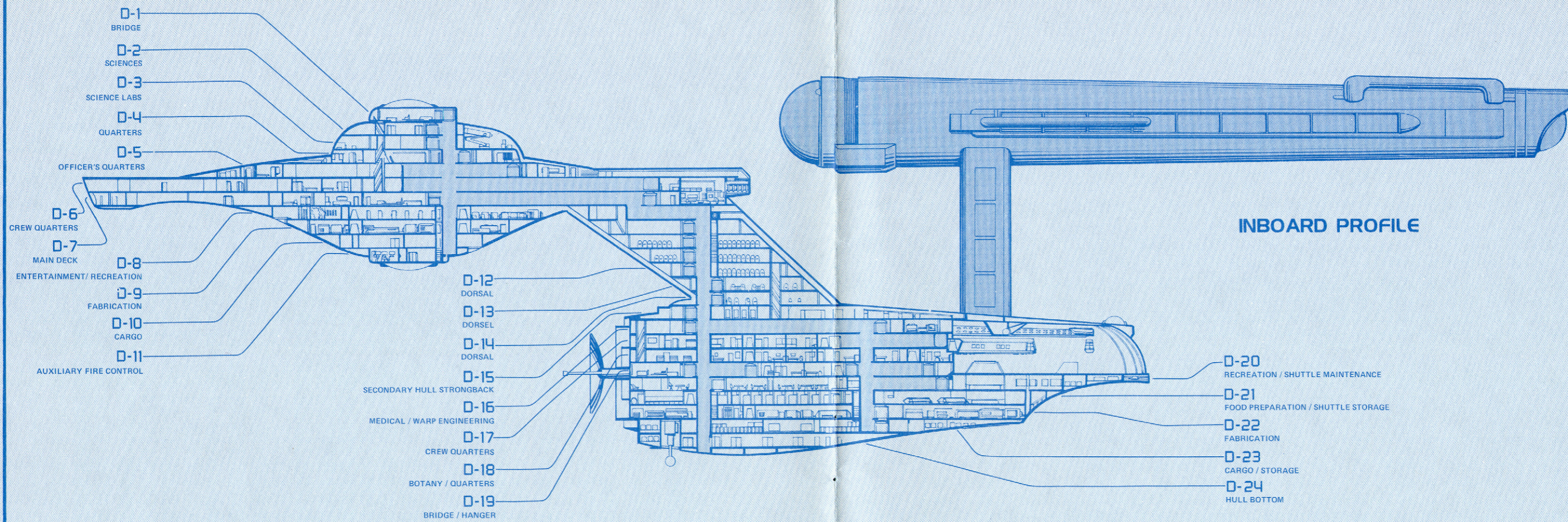

U.S.S. ENTERPRISE
 Constitution Class Heavy Cruiser
 Sheet 2 of 9 Side A

D-5 Officer's Quarters



U.S.S. ENTERPRISE
Constitution Class Heavy Cruiser
Sheet 2 of 9 Side B

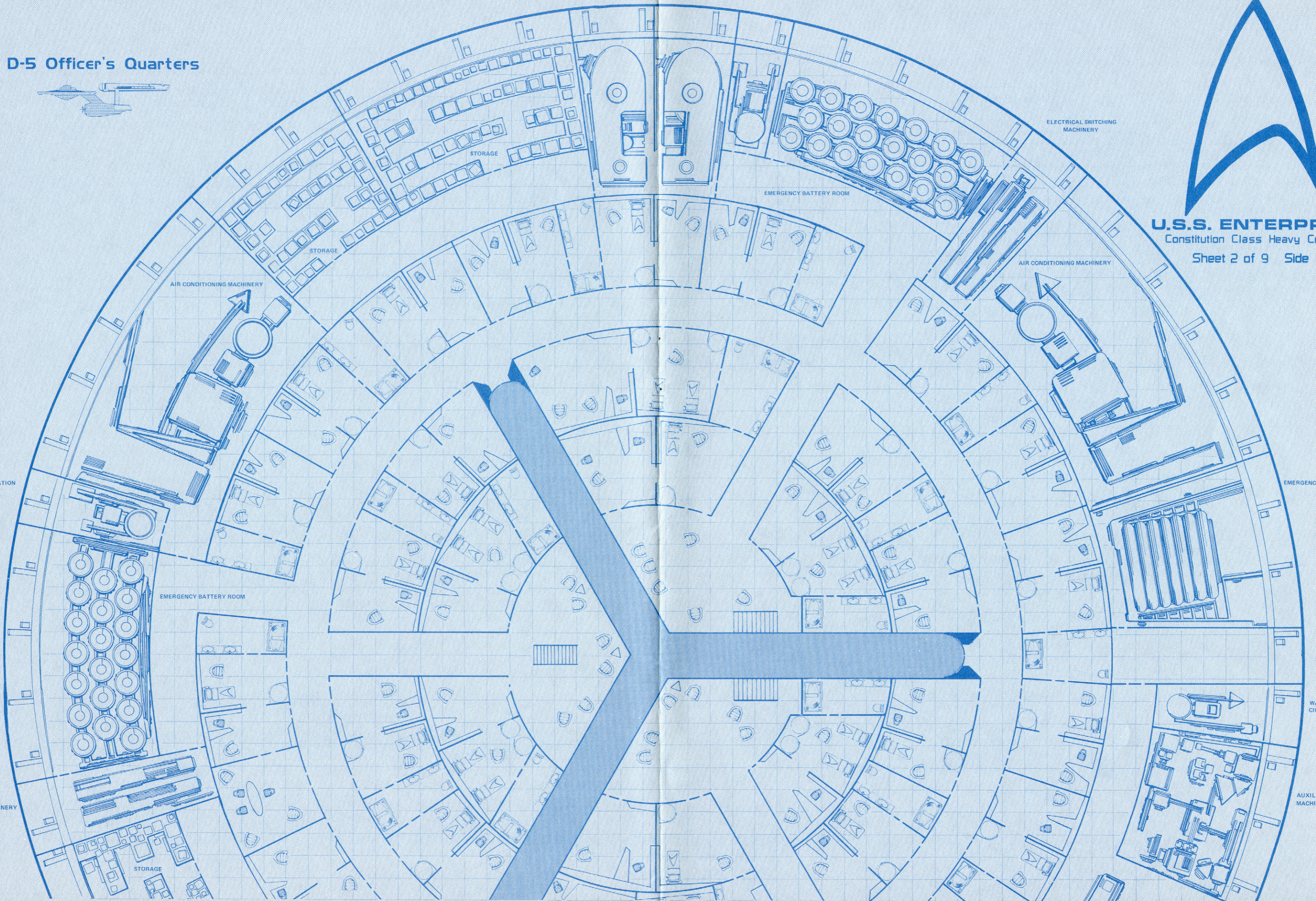

D-6 Crew's Quarters



U.S.S. ENTERPRISE
Constitution Class Heavy Cruiser
Sheet 3 of 9 Side A

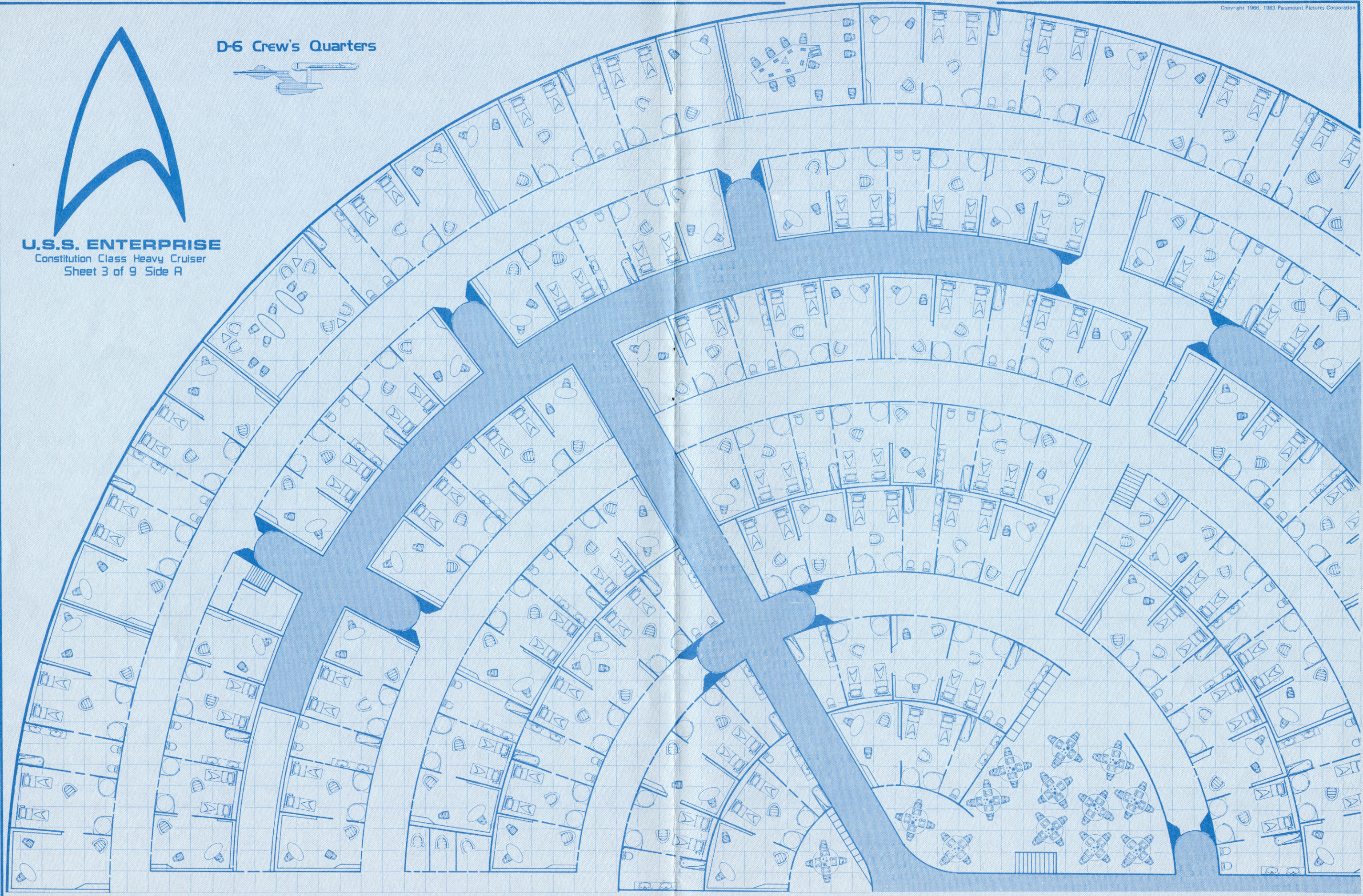

D-5 Officer's Quarters

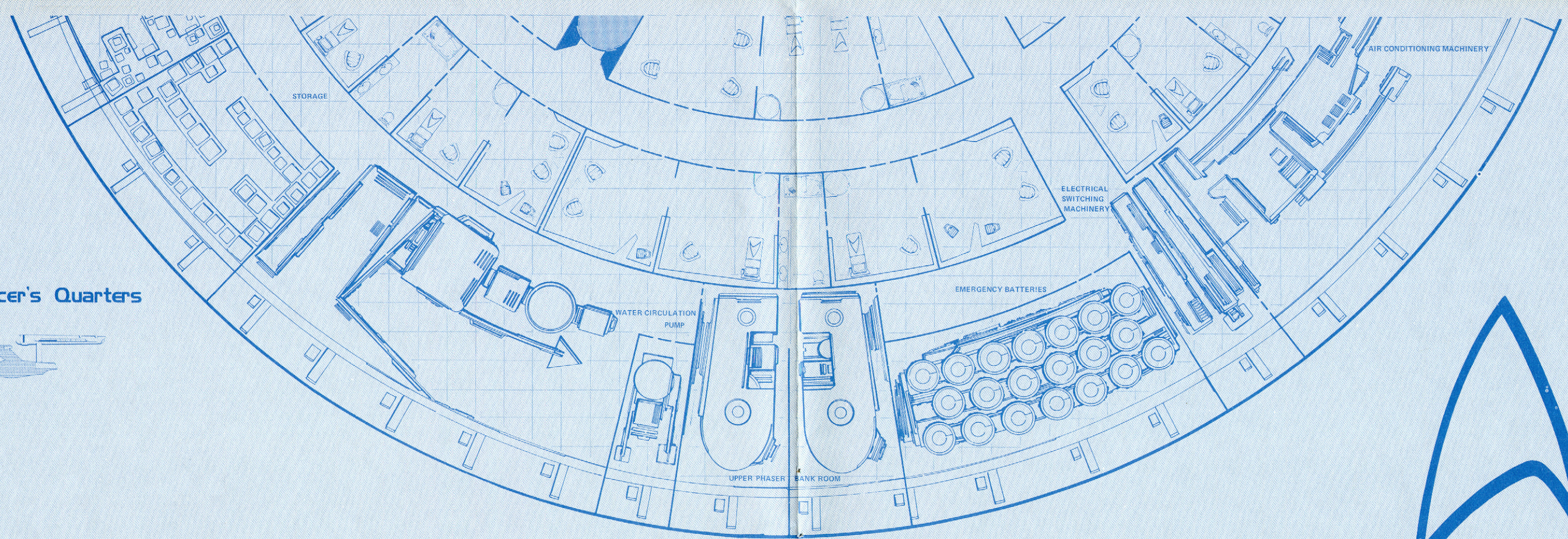
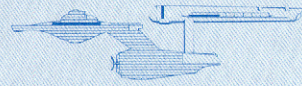

D-21 Food Preparation Shuttle Storage

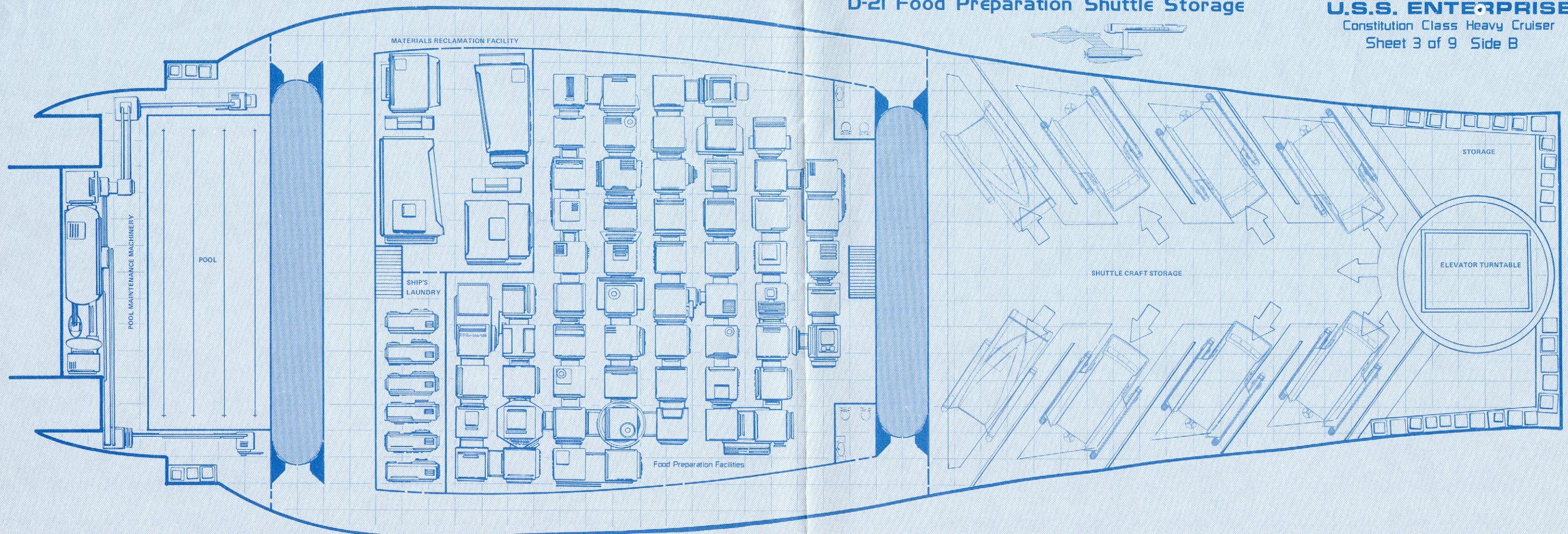
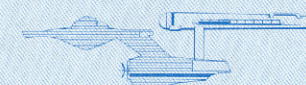

U.S.S. ENTERPRISE
Constitution Class Heavy Cruiser
Sheet 3 of 9 Side B



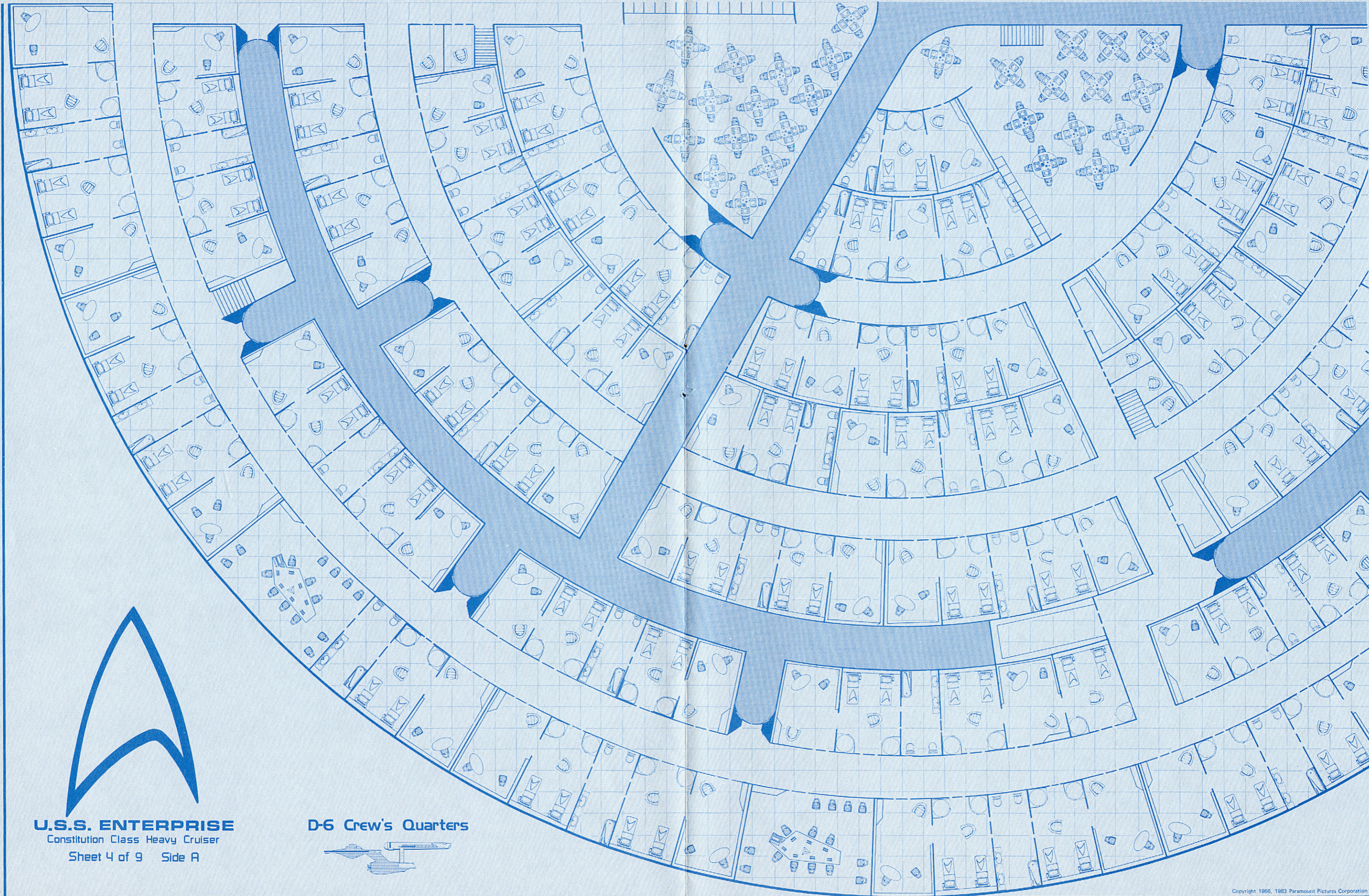

U.S.S. ENTERPRISE
Constitution Class Heavy Cruiser
Sheet 4 of 9 Side A

D-6 Crew's Quarters



D-8 Entertainment Recreation

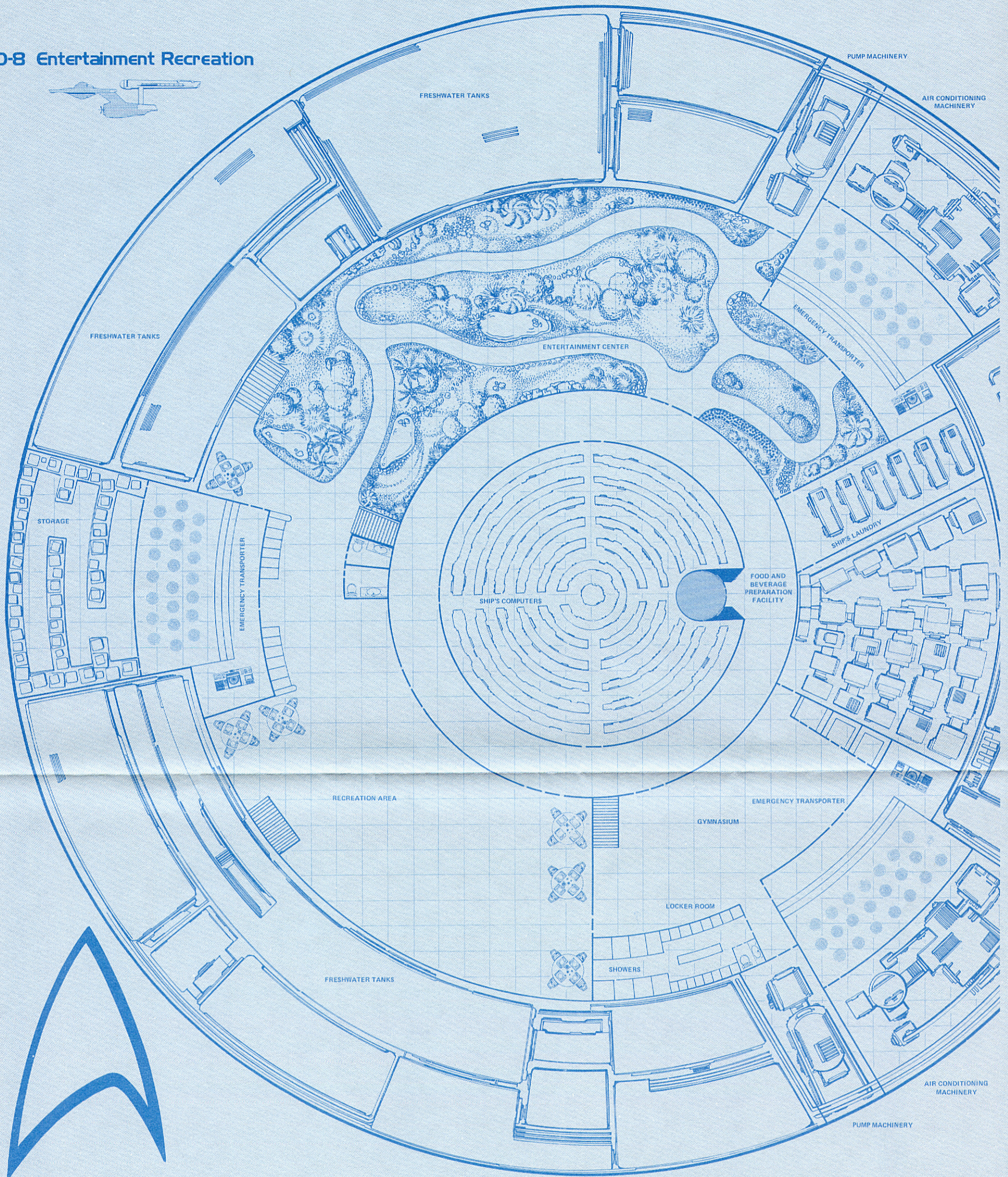

U.S.S. ENTERPRISE
 Constitution Class Heavy Cruiser
 Sheet 4 of 9 Side B

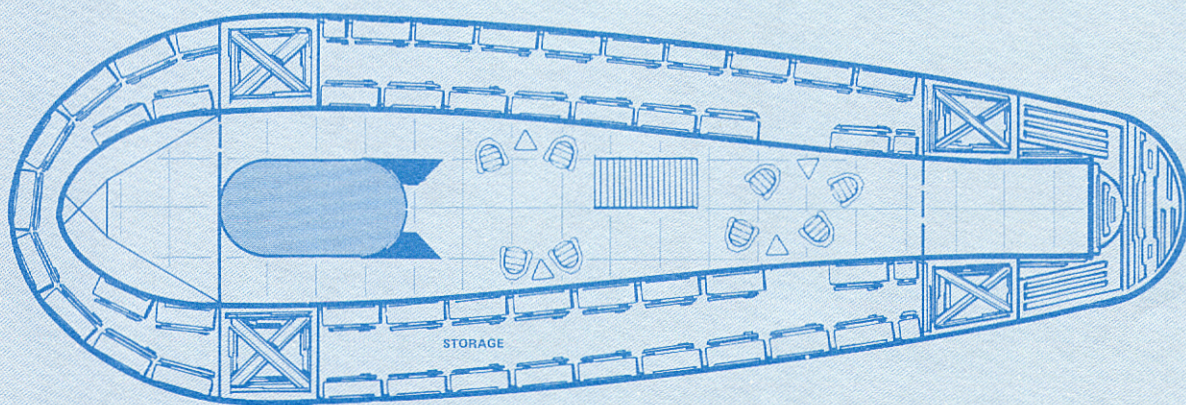

D-14 Dorsal

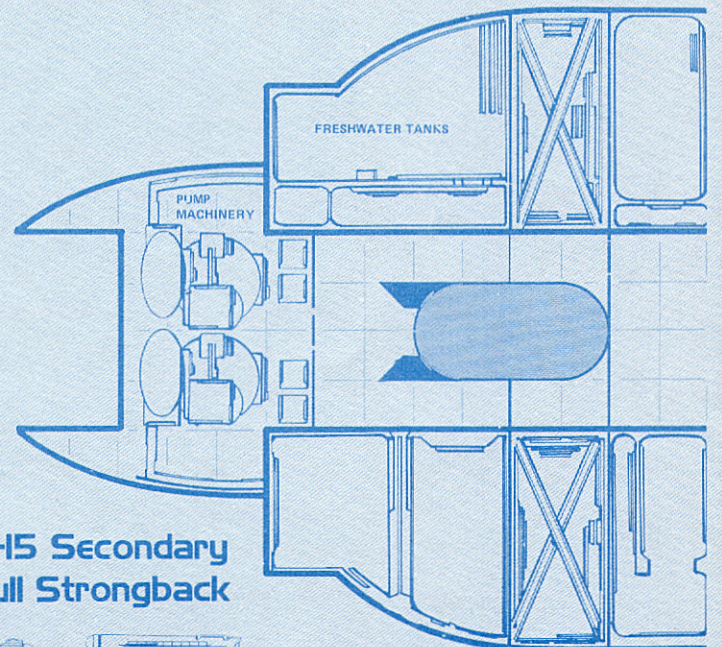

D-15 Secondary Hull Strongback

D-6 Crew's Quarters

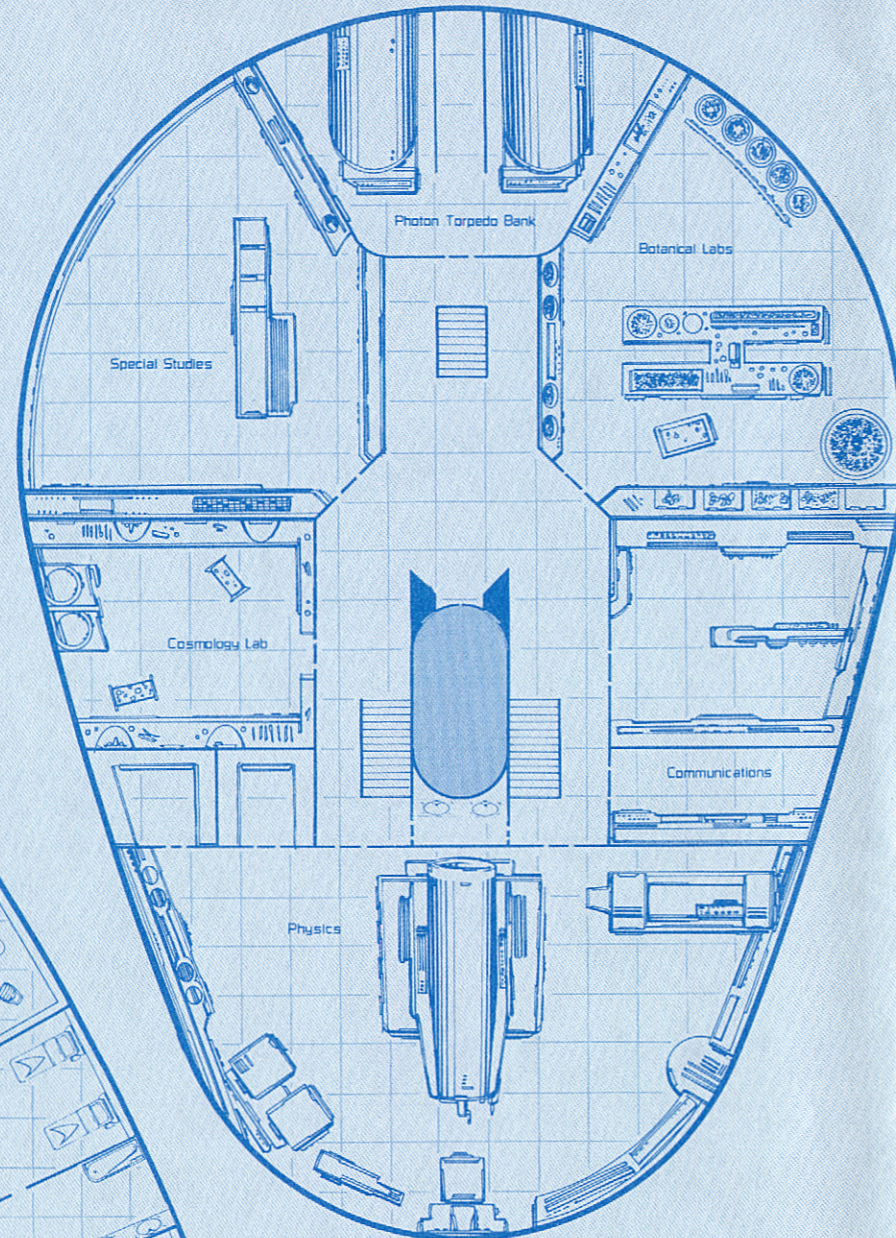
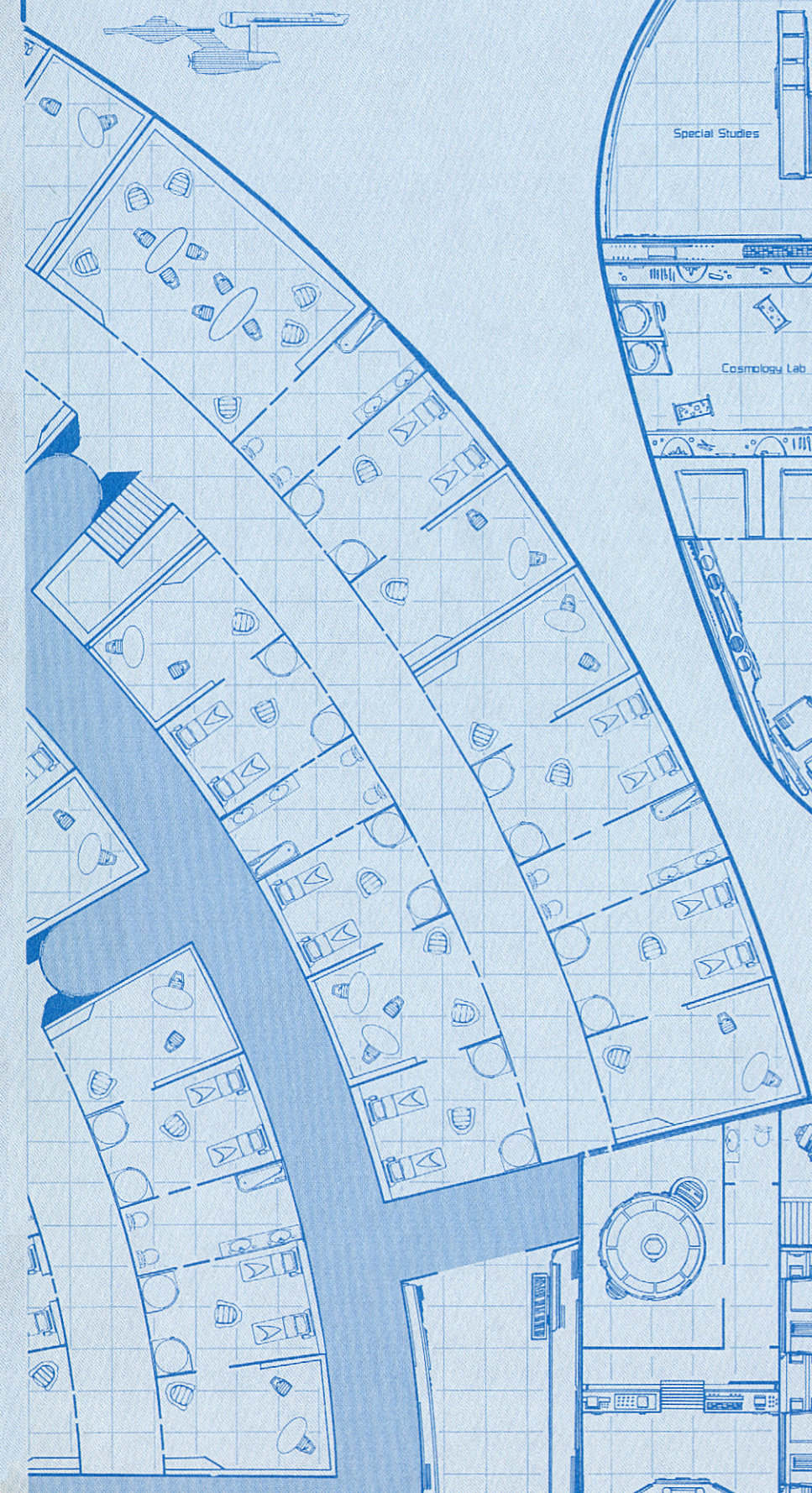

D-3 Science Labs

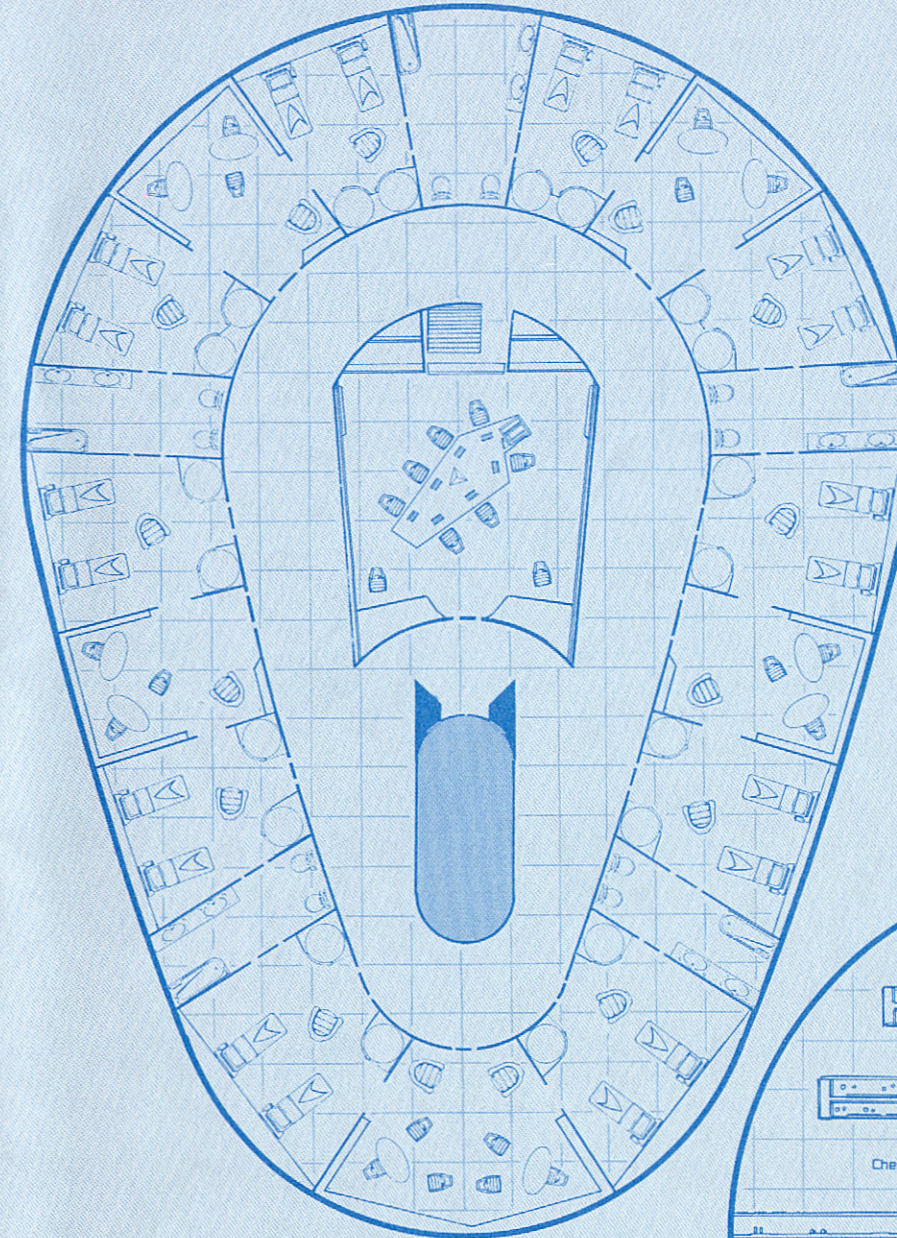

D-4 Quarters

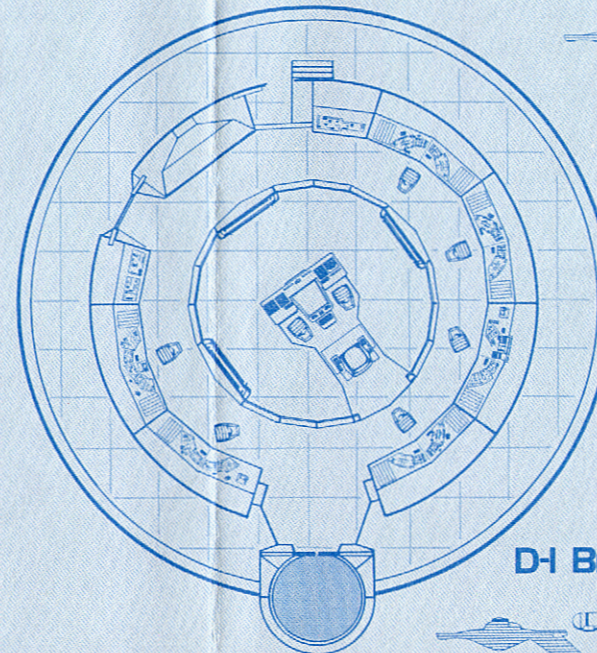

D-1 Bridge

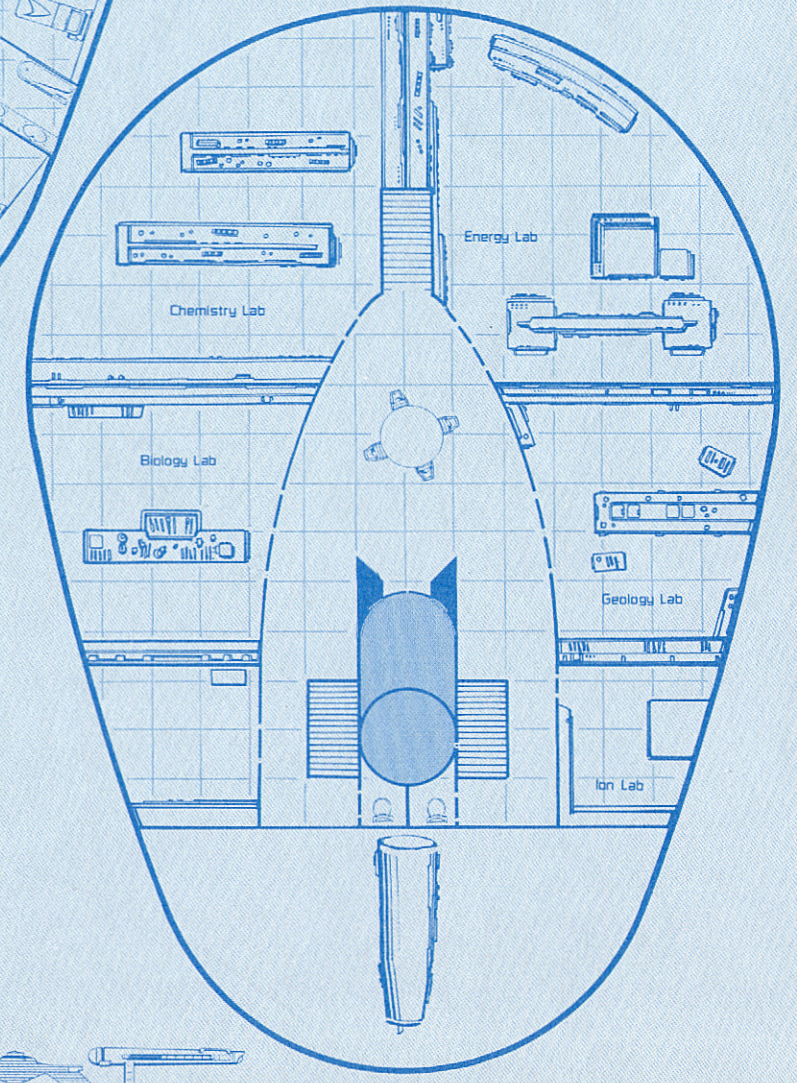

D-2 Sciences



U.S.S. ENTERPRISE
Constitution Class Heavy Cruiser
Sheet 5 of 9 Side A

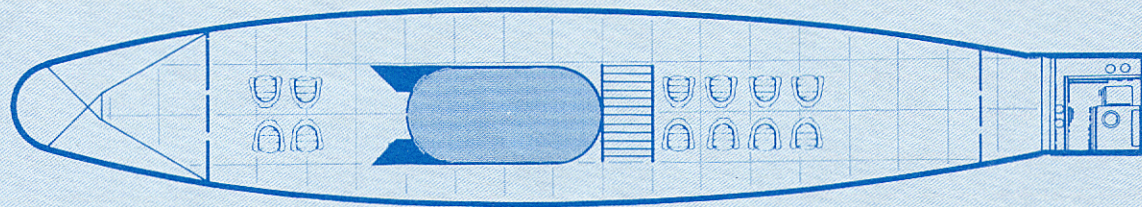

D-11 Dorsal

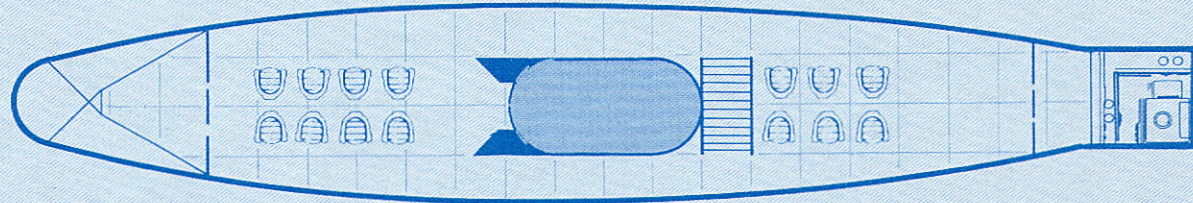

D-10 Dorsal

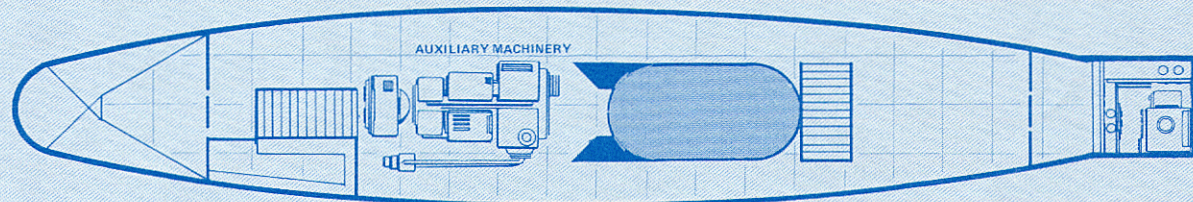

D-9 Dorsal

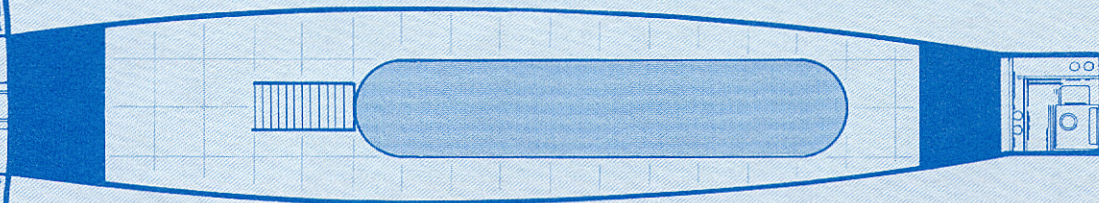
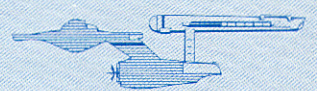

FOOD CONVEYOR

FRESH WATER TANKS

D-8 Entertainment Recreation

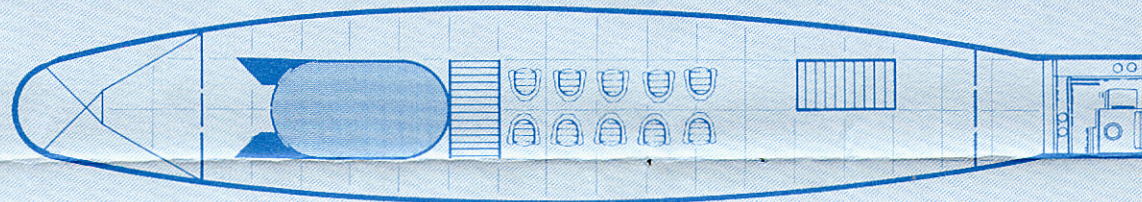

D-12 Dorsal

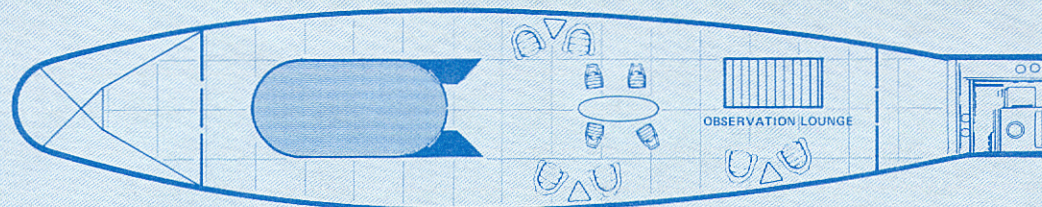

D-13 Dorsal

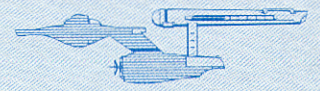

U.S.S. ENTERPRISE
 Constitution Class Heavy Cruiser
 Sheet 5 of 9 Side B

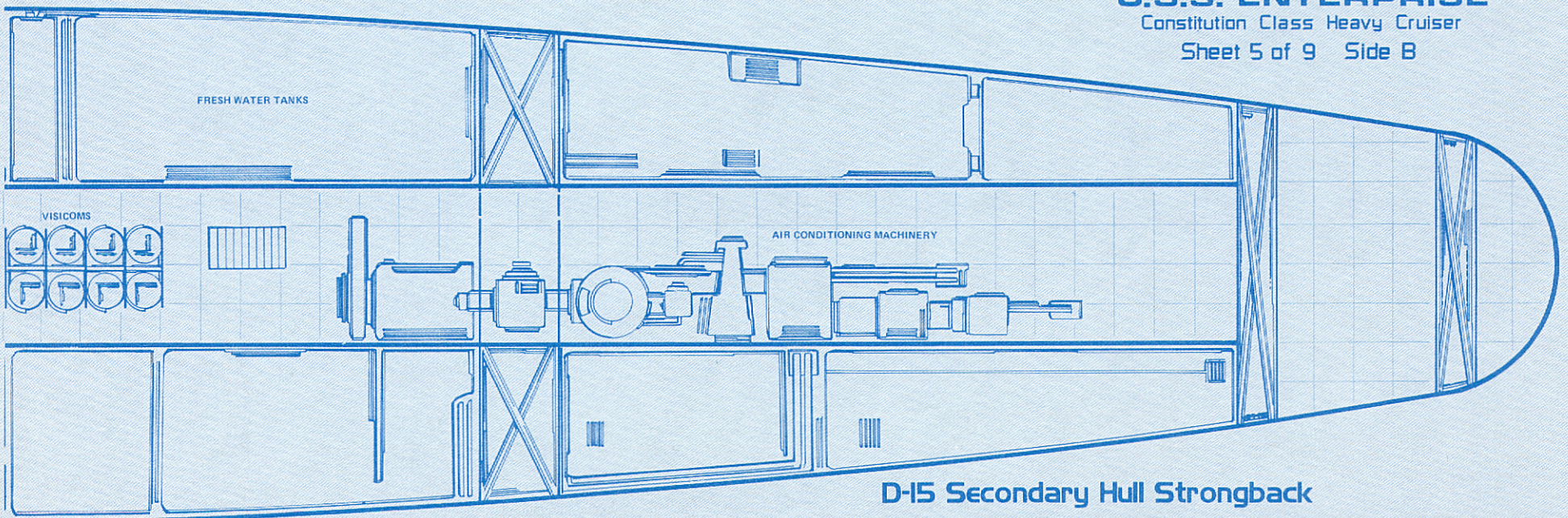

FRESH WATER TANKS

VISICOMS

AIR CONDITIONING MACHINERY

D-15 Secondary Hull Strongback





D-6 Crew's Quarters

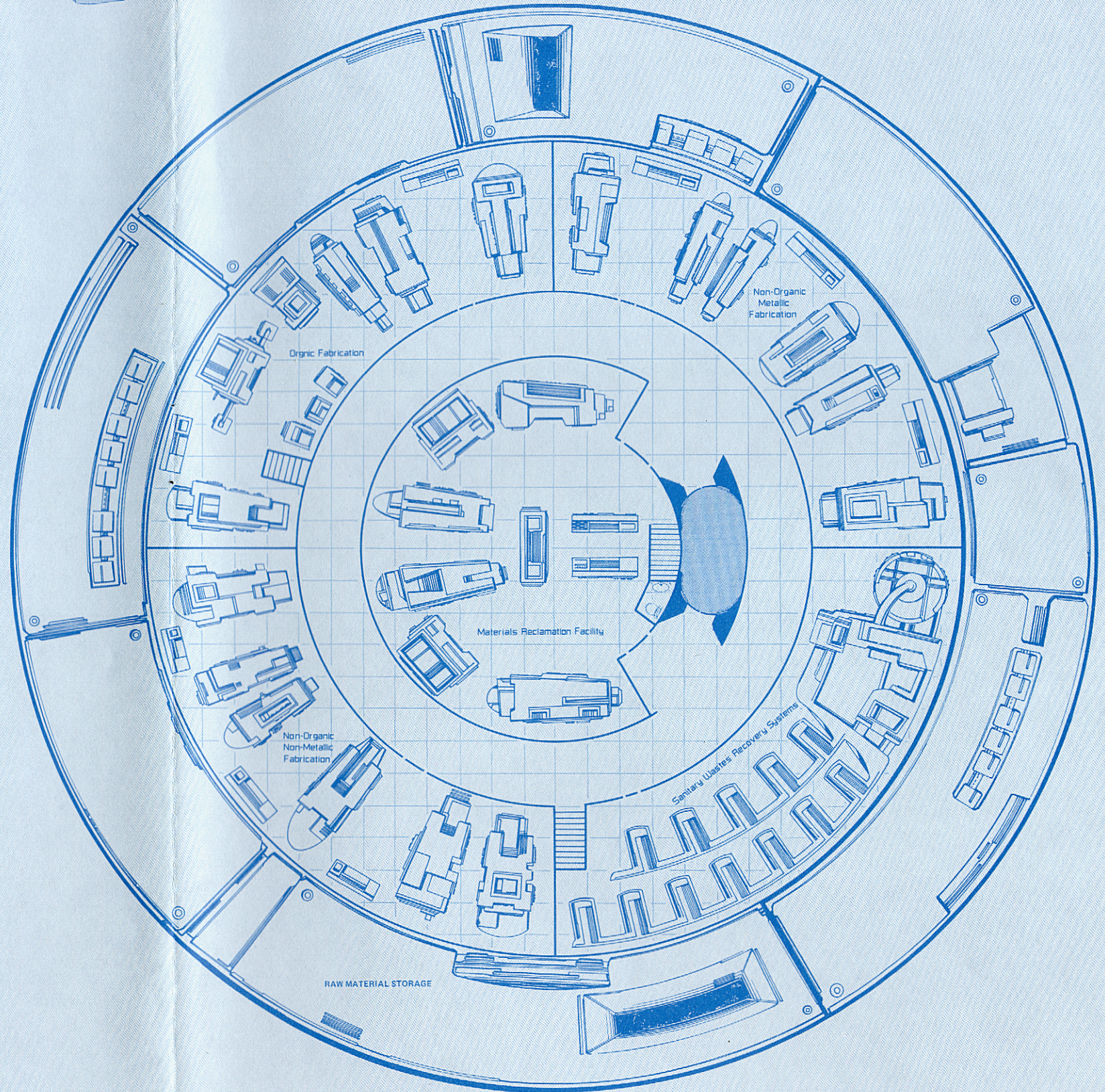
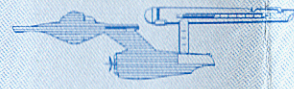

D-9 Fabrication



U.S.S. ENTERPRISE
 Constitution Class Heavy Cruiser
 Sheet 6 of 9 Side A

D-16 Medical/Warp Engineering

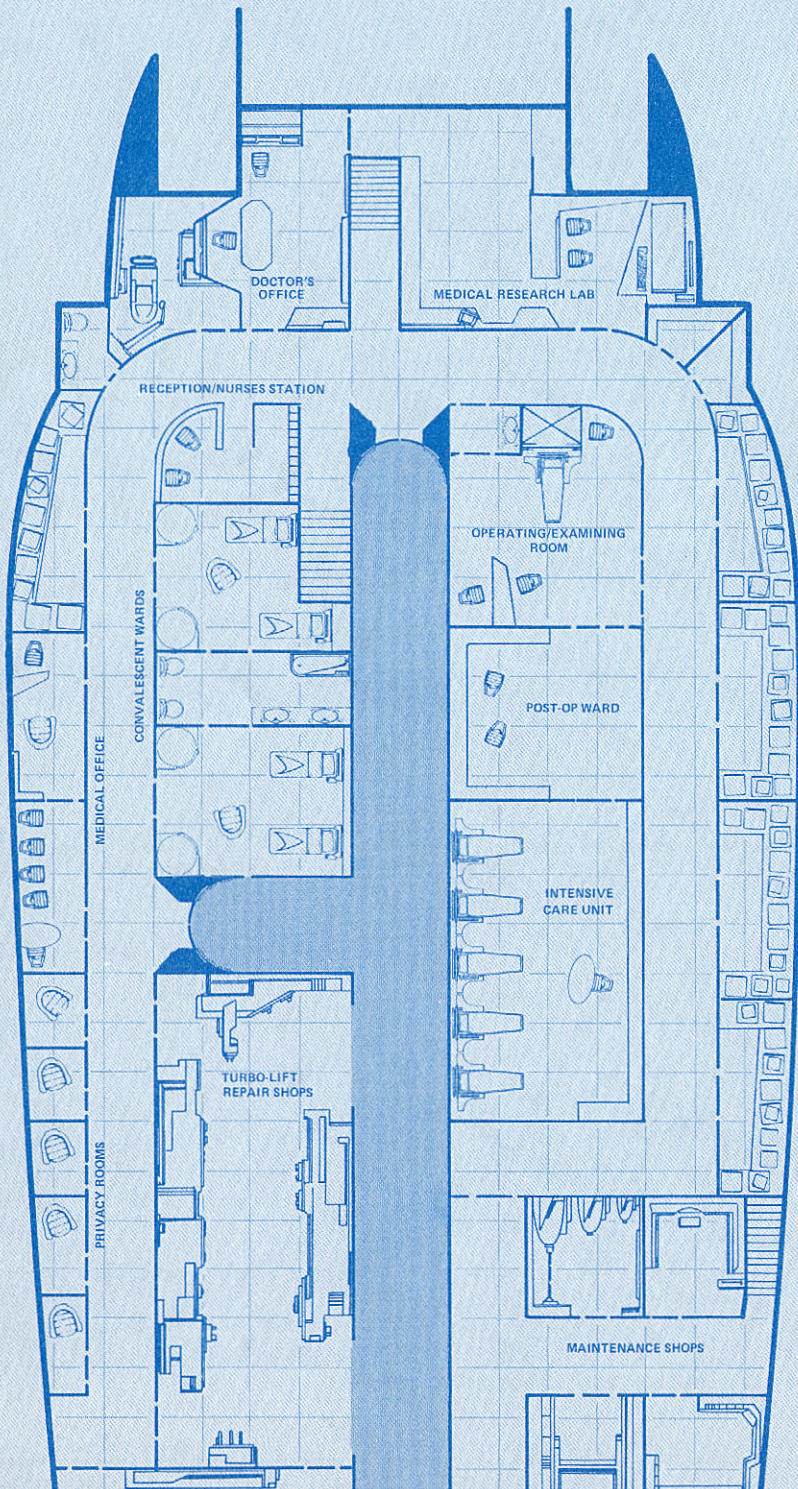

D-17 Crew's Quarters

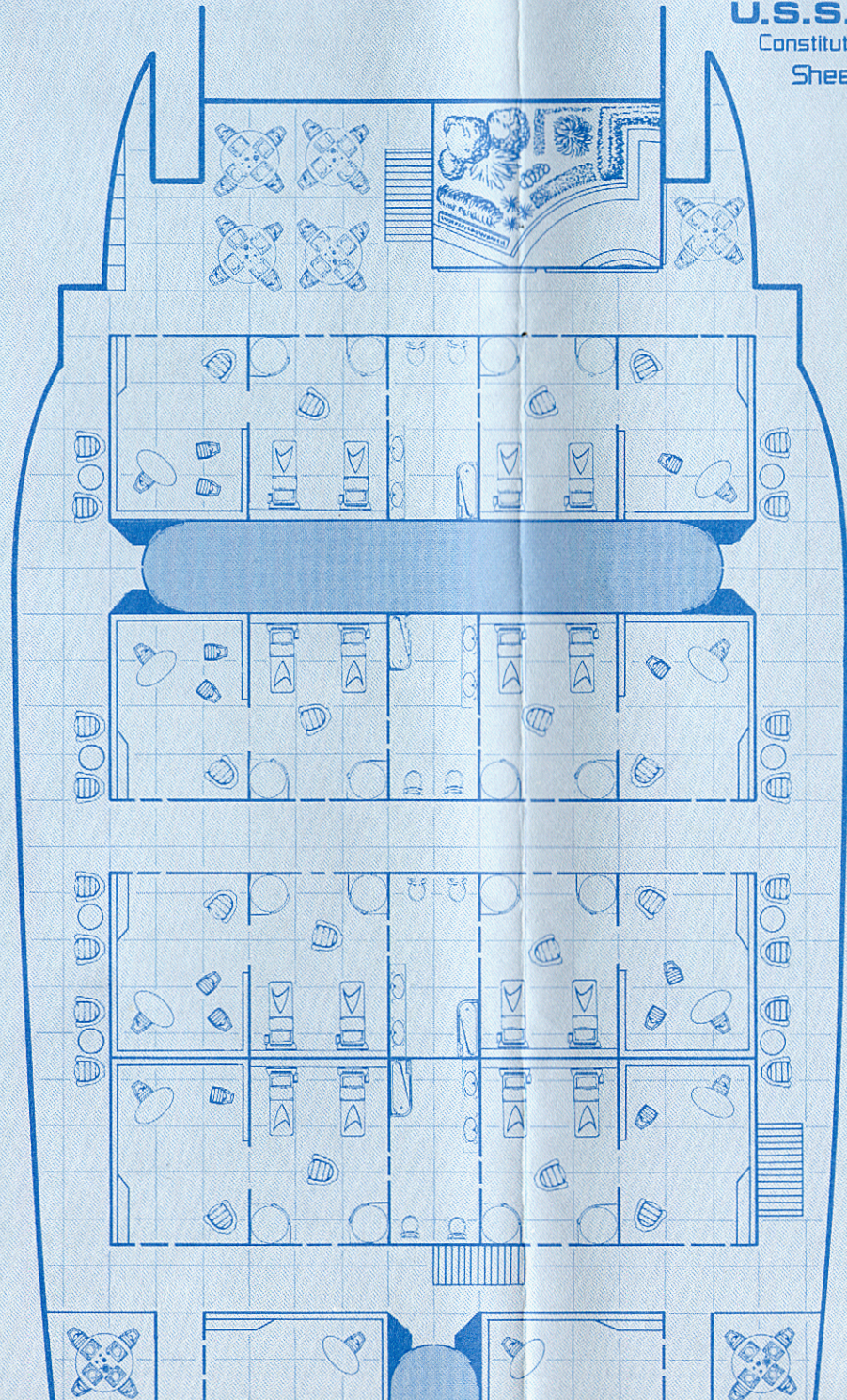

U.S.S. ENTERPRISE

Constitution Class Heavy Cruiser
Sheet 6 of 9 Side B

D-18 Botany/Quarters

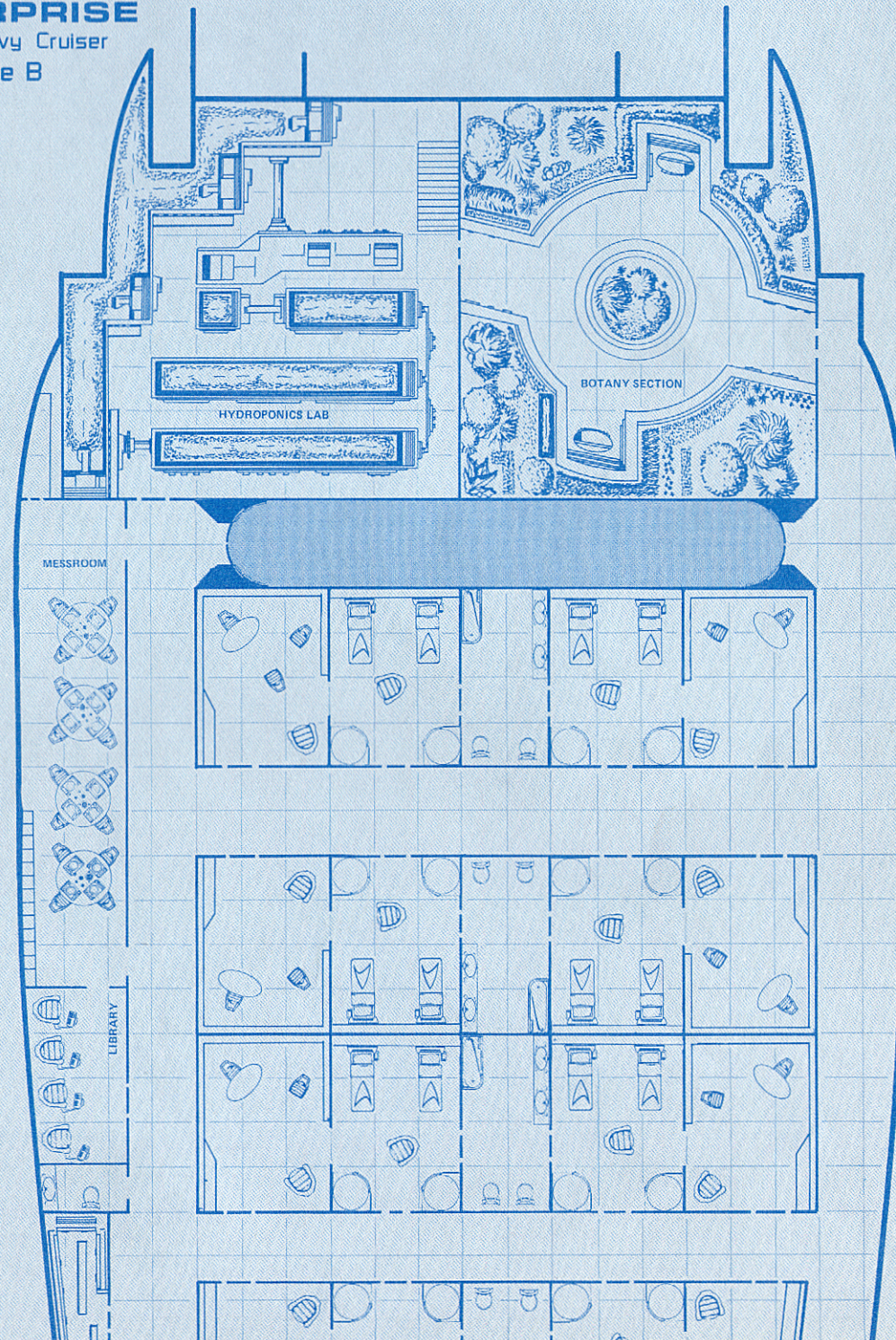

D-7 Main Deck



U.S.S. ENTERPRISE
Constitution Class Heavy Cruiser
Sheet 7 of 9 Side A

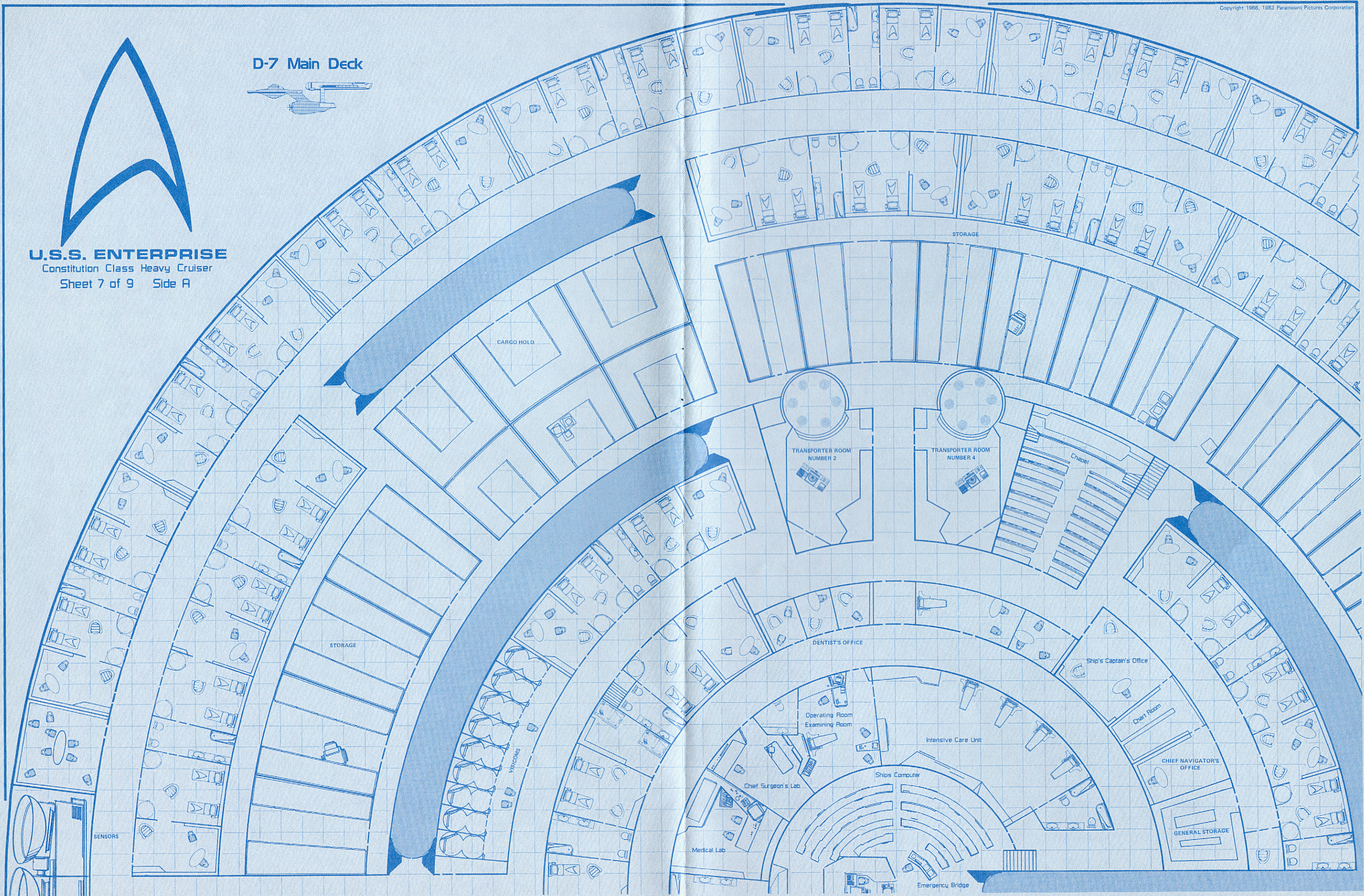

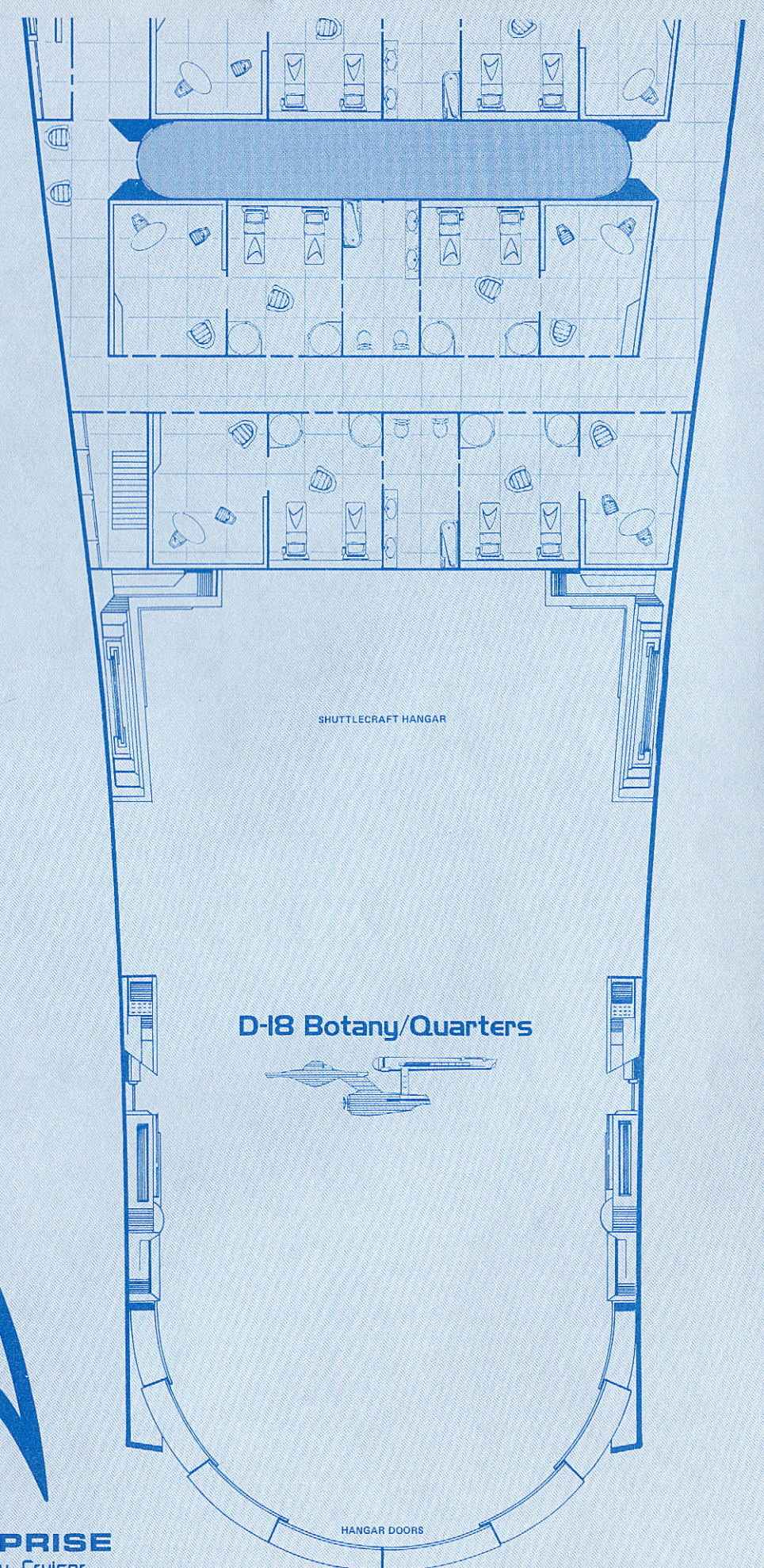
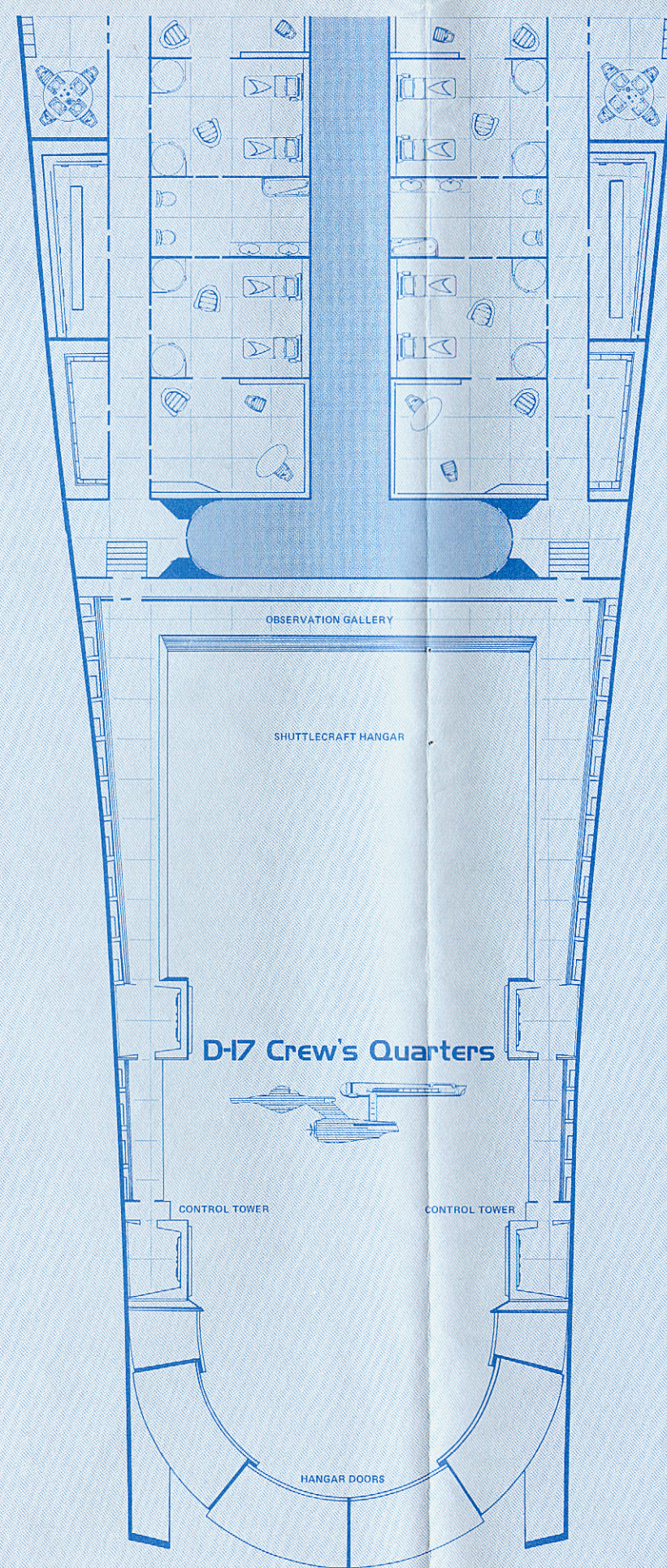
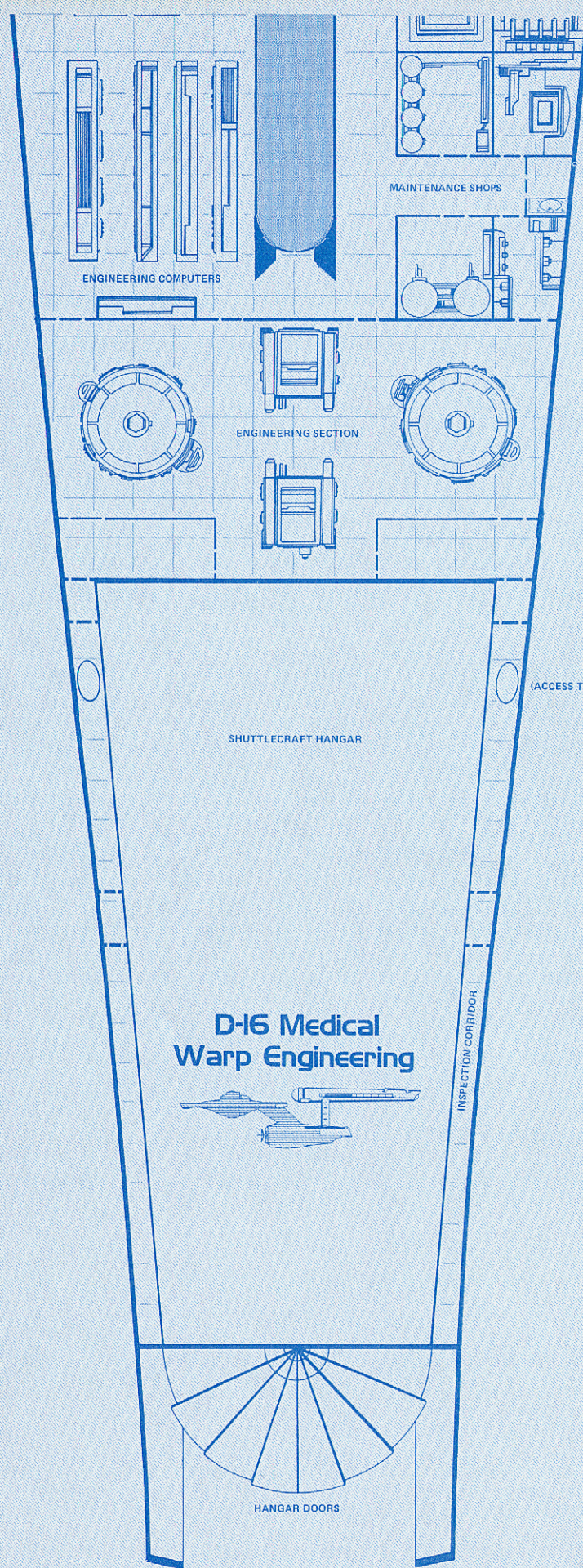

U.S.S. ENTERPRISE
Constitution Class Heavy Cruiser
Sheet 7 of 9 Side B

D-7 Main Deck

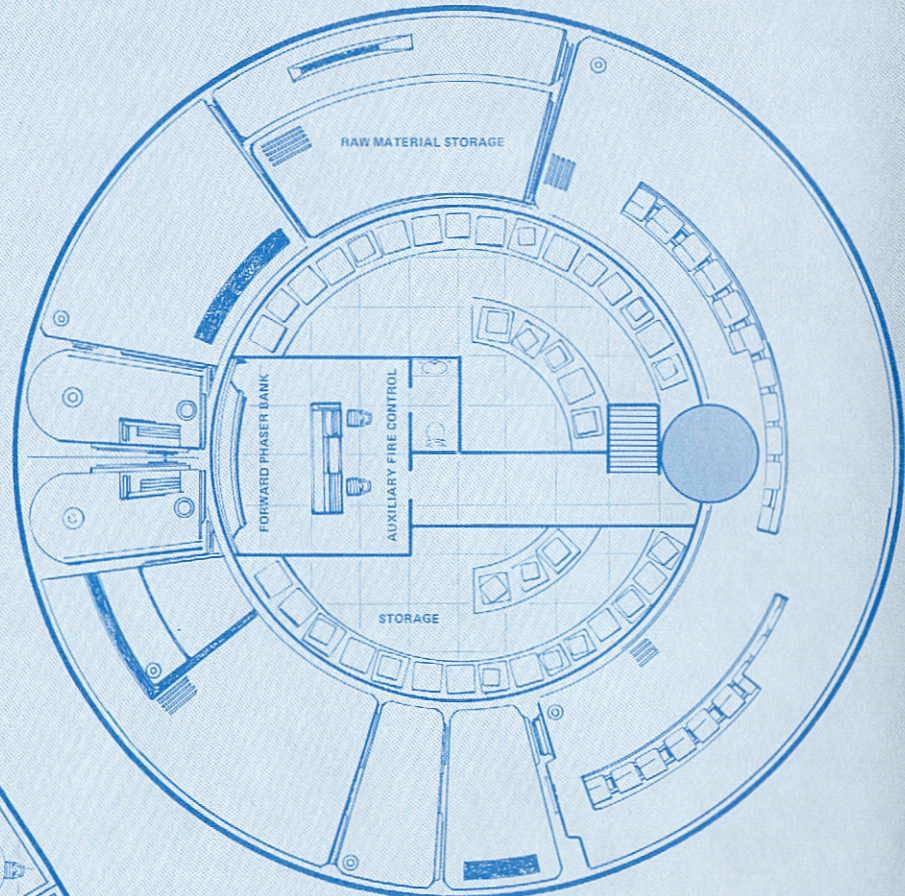
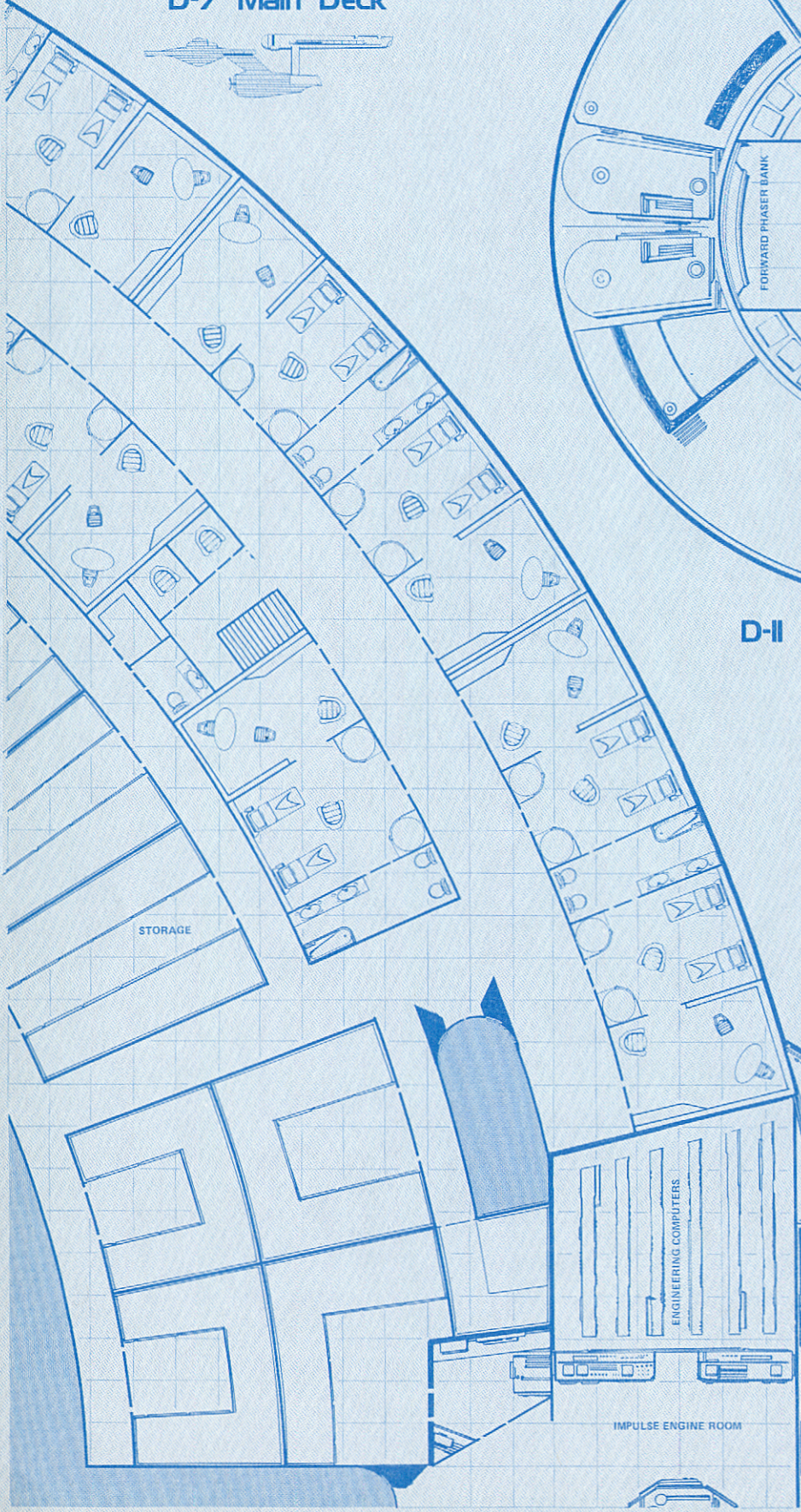

D-II Auxiliary Fire Control

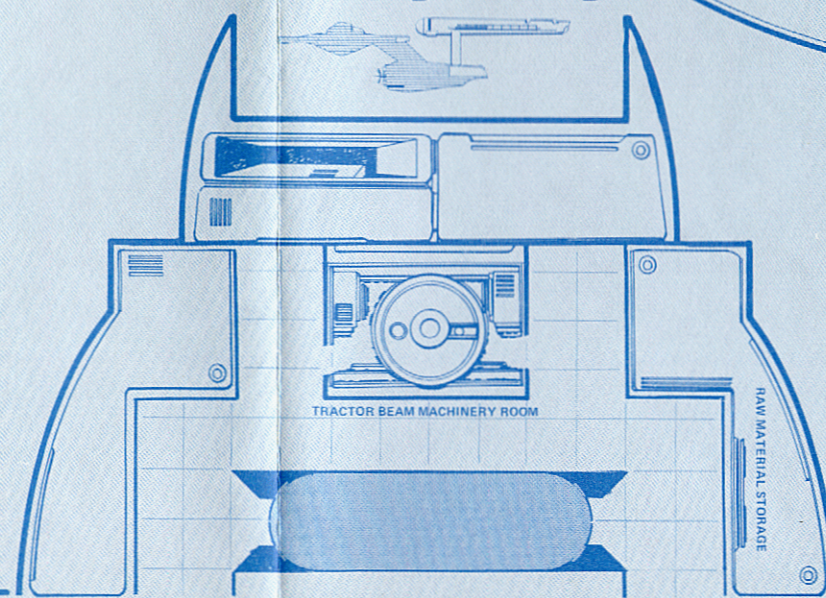

D-23 Cargo Storage

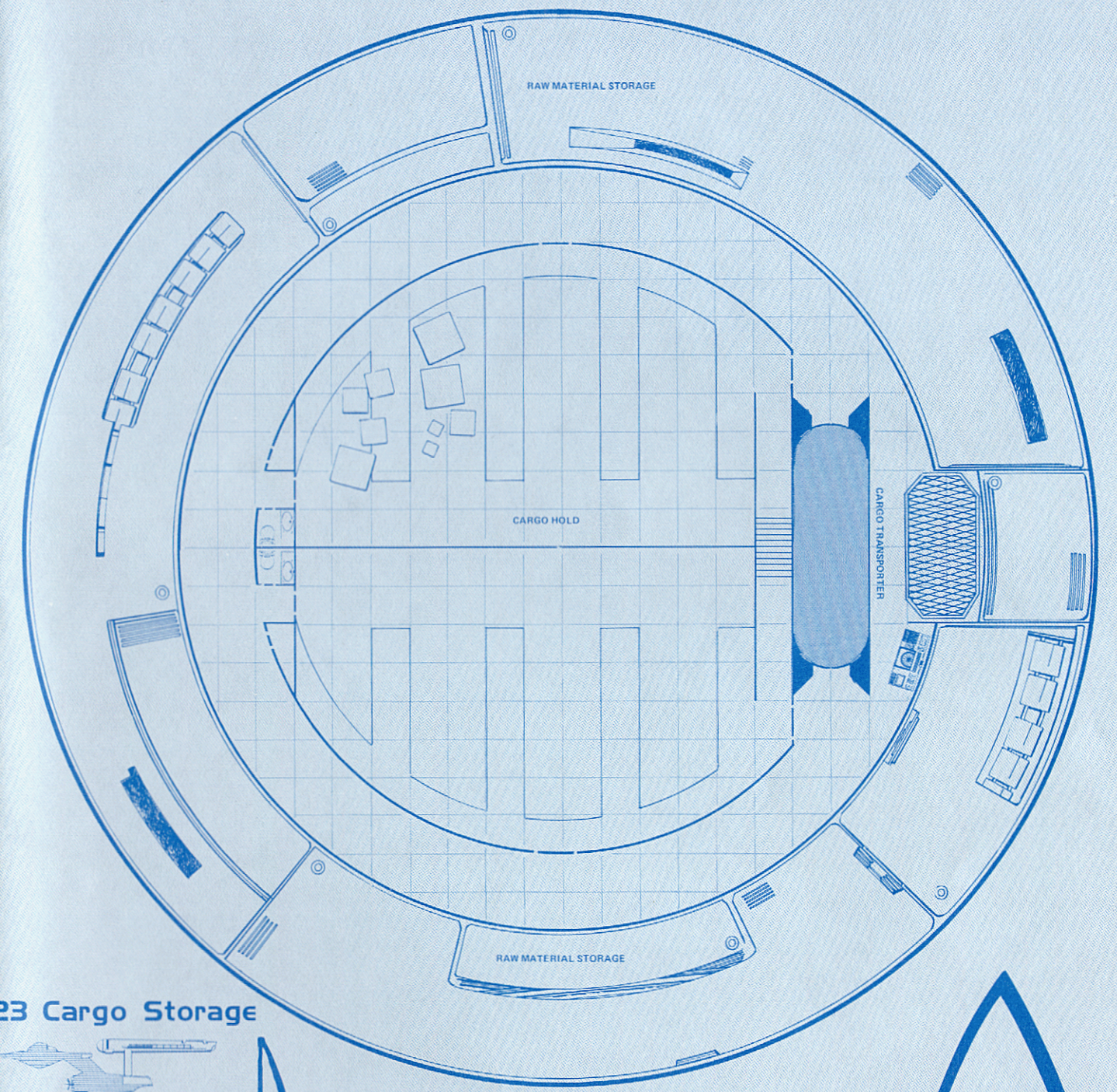

D-10 Cargo

U.S.S. ENTERPRISE
 Constitution Class Heavy Cruiser
 Sheet 8 of 9 Side A

U.S.S. ENTERPRISE

Constitution Class Heavy Cruiser

Sheet 8 of 9 Side B

D-22 Fabrication Facilities

D-19 Bridge Hangar

D-20 Recreation Shuttle Maintenance

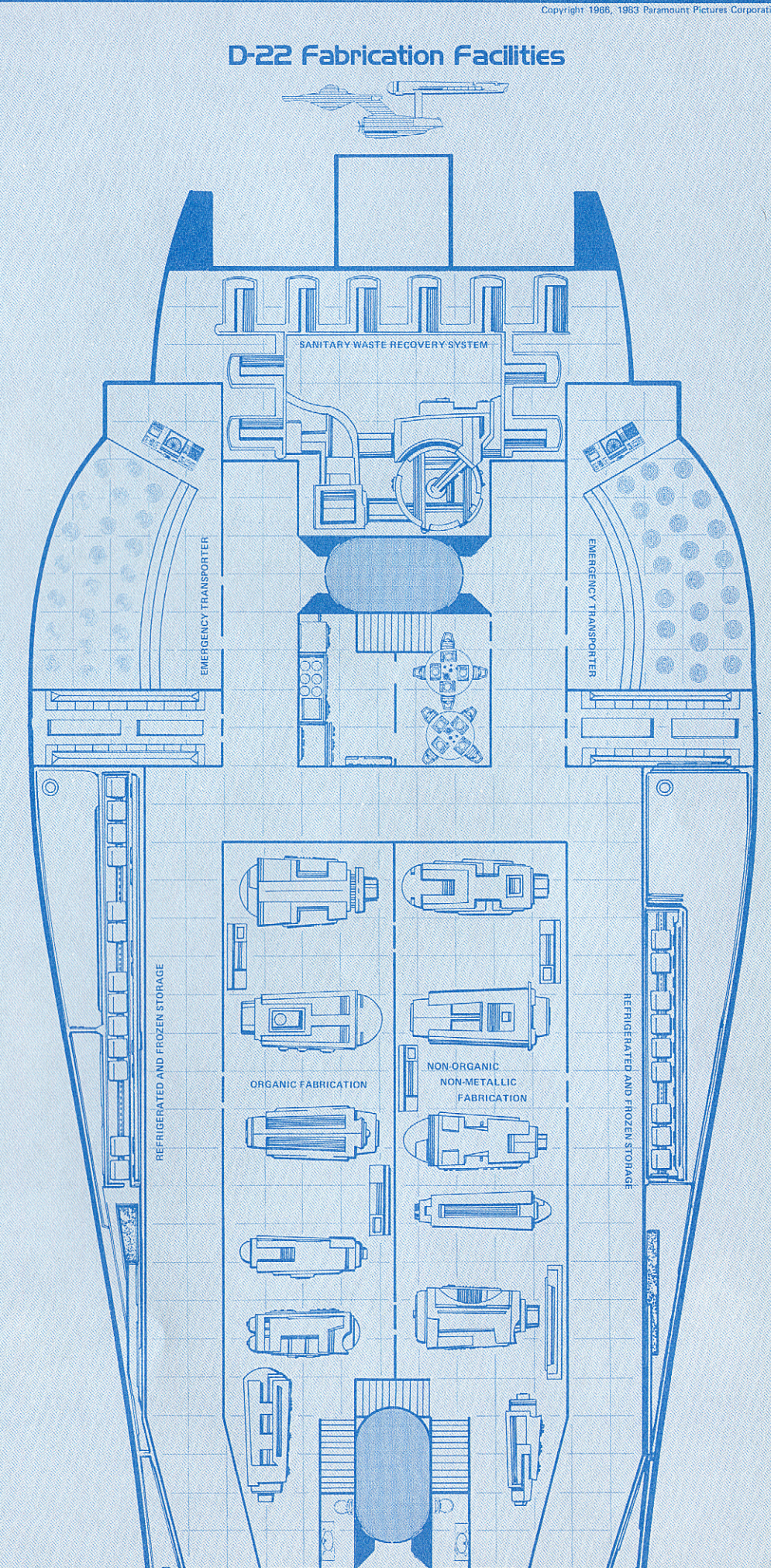
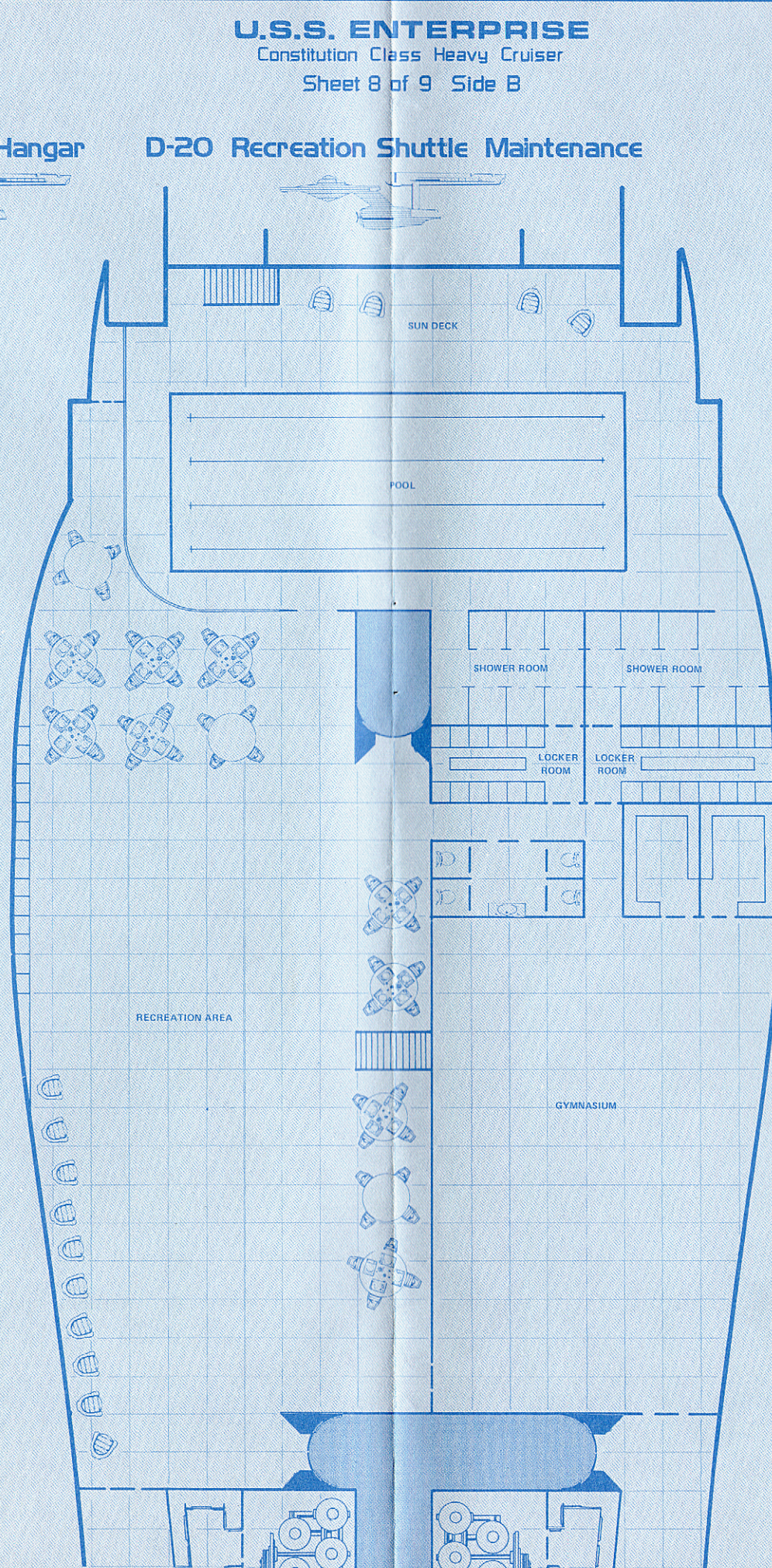
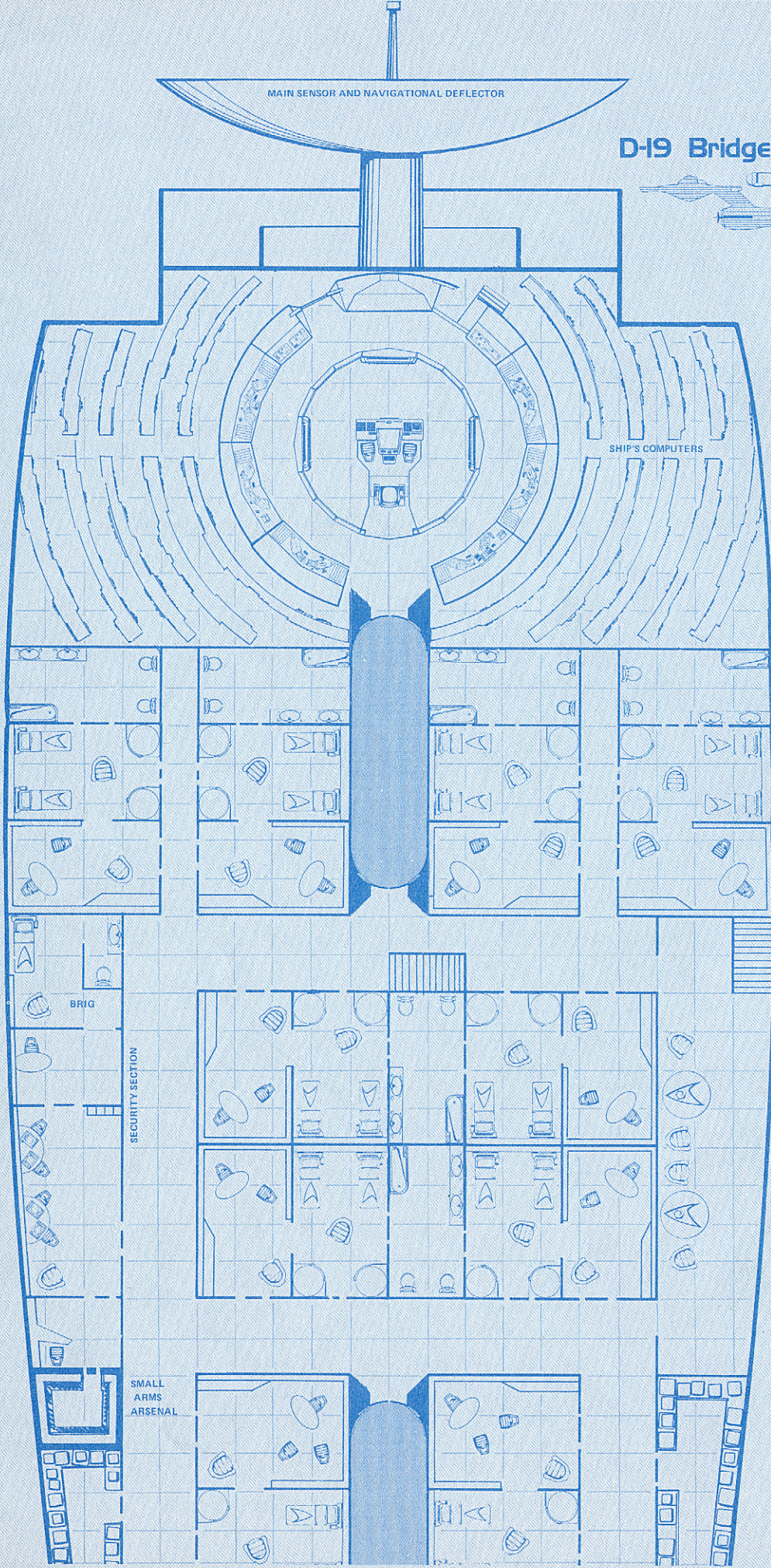

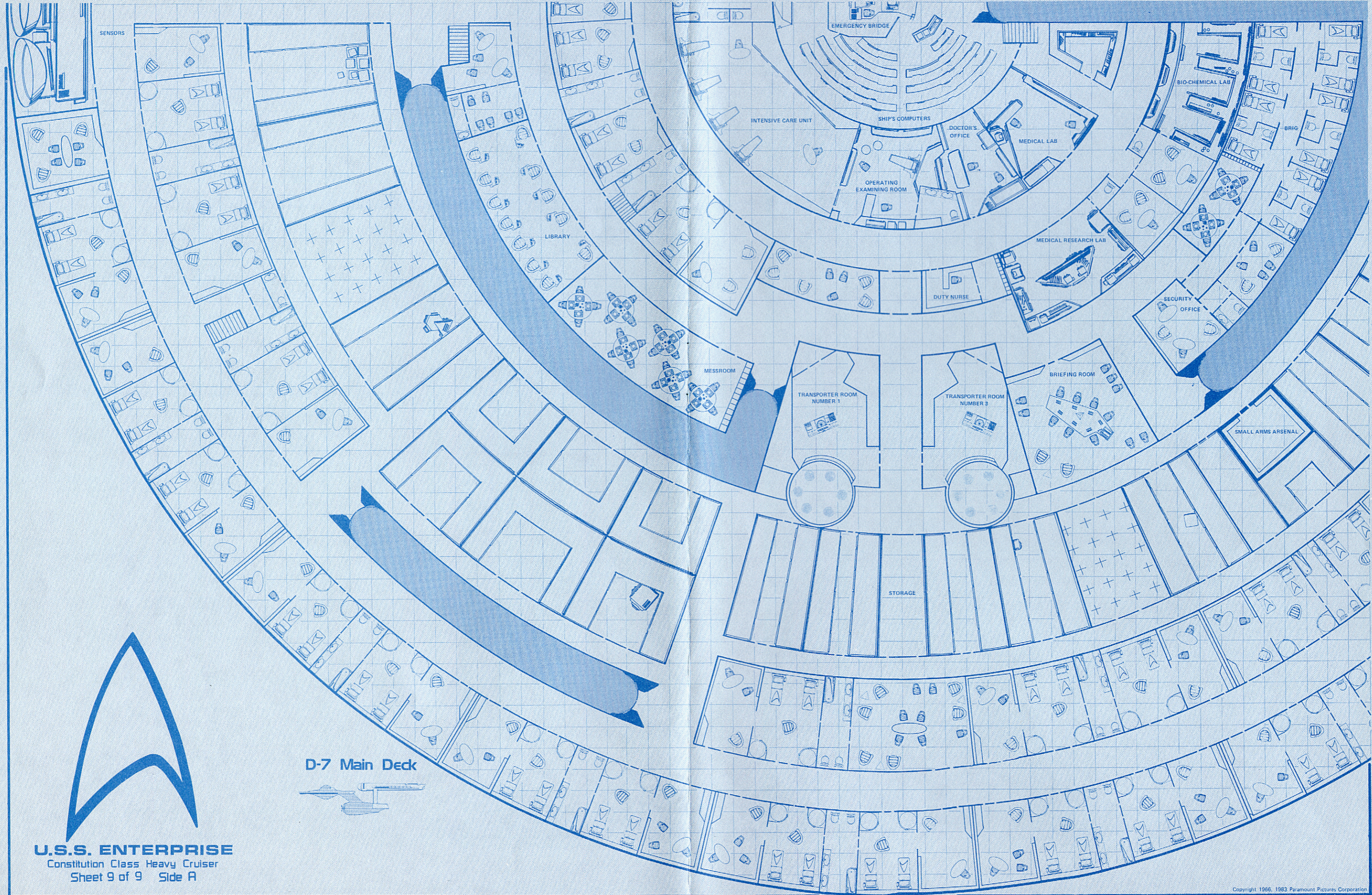

SENSORS

EMERGENCY BRIDGE

INTENSIVE CARE UNIT

SHIP'S COMPUTERS

DOCTOR'S OFFICE

MEDICAL LAB

BIO-CHEMICAL LAB

BRIG

OPERATING EXAMINING ROOM

MEDICAL RESEARCH LAB

DUTY NURSE

SECURITY OFFICE

LIBRARY

MESSROOM

TRANSPORTER ROOM NUMBER 1

TRANSPORTER ROOM NUMBER 2

BRIEFING ROOM

SMALL ARMS ARSENAL

STORAGE

D-7 Main Deck



U.S.S. ENTERPRISE
Constitution Class Heavy Cruiser
Sheet 9 of 9 Side A

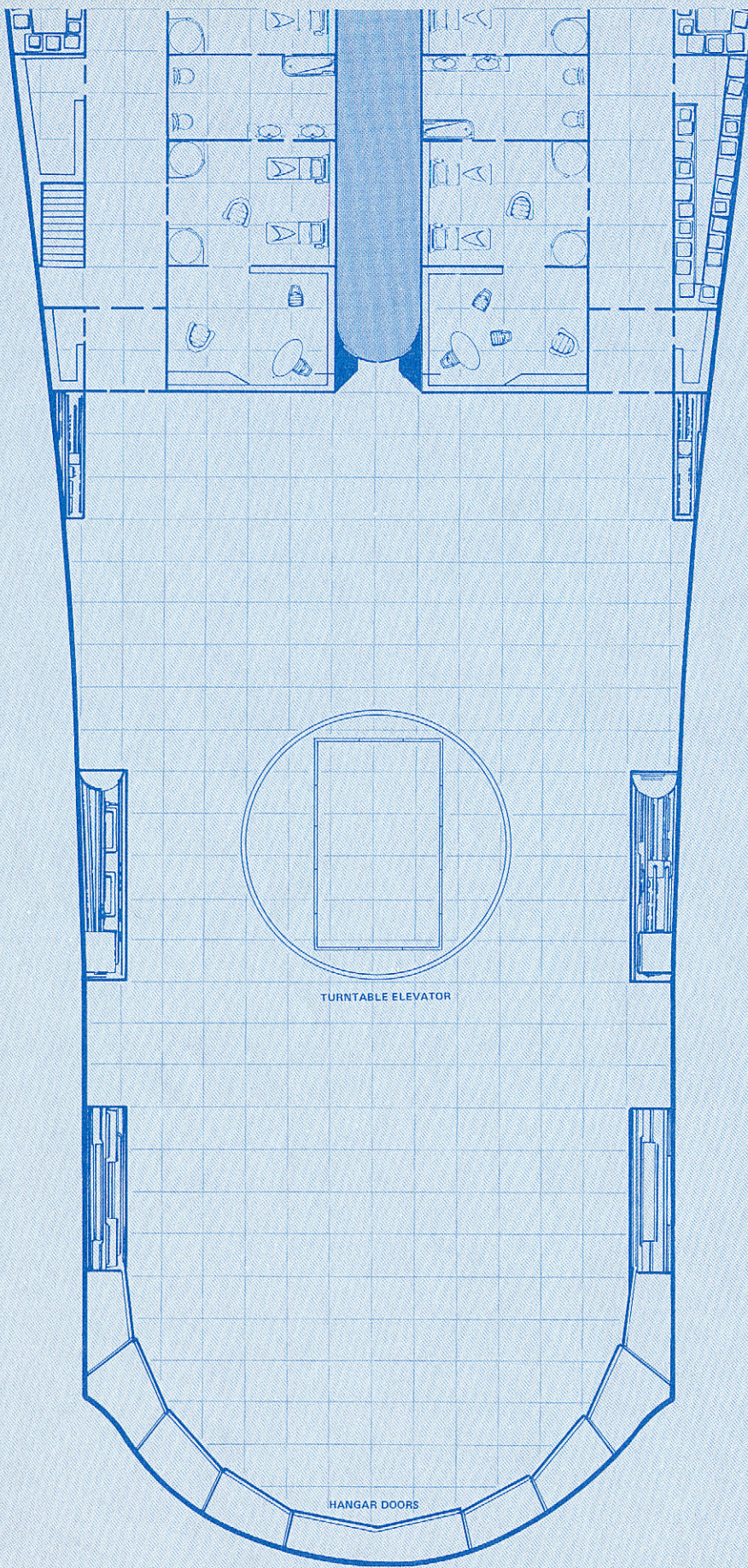

D-19 Bridge Hangar

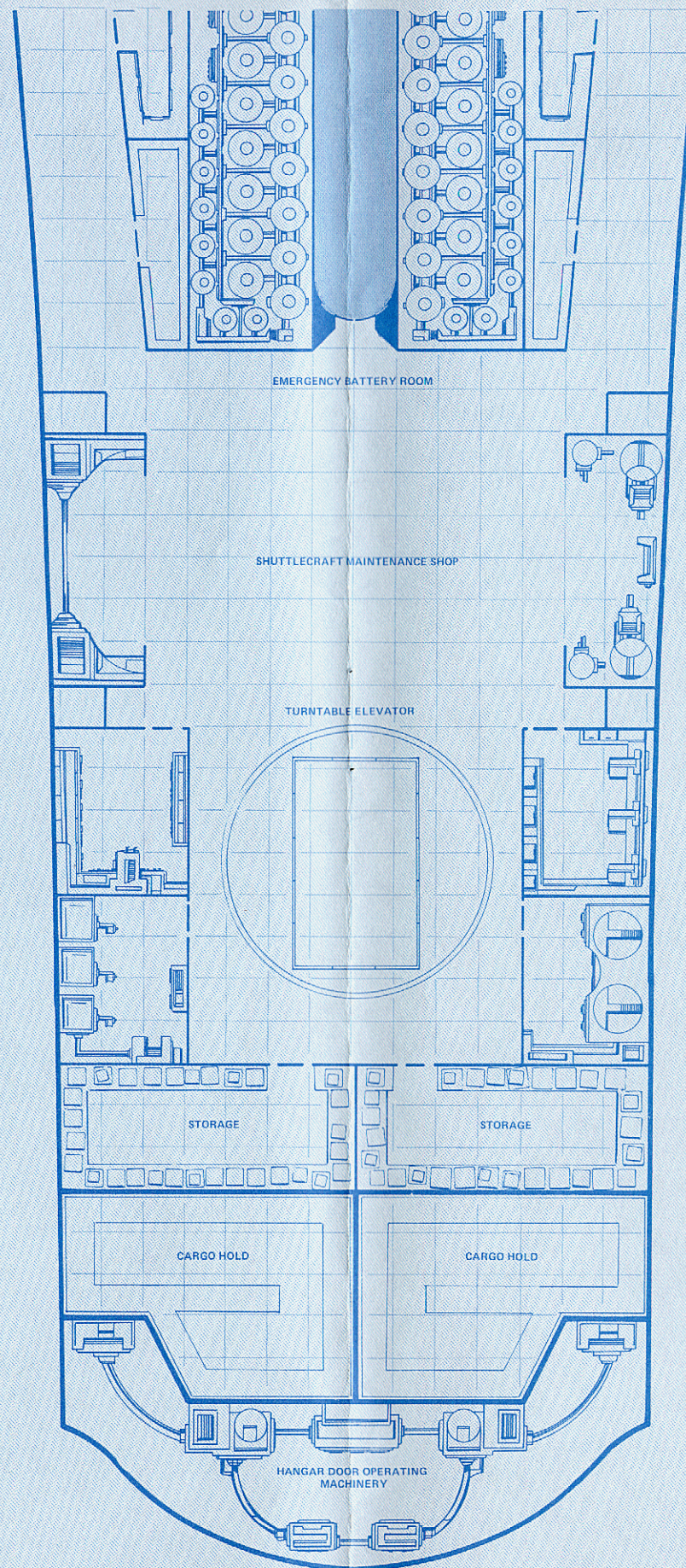

D-20 Recreation Shuttle Maintenance

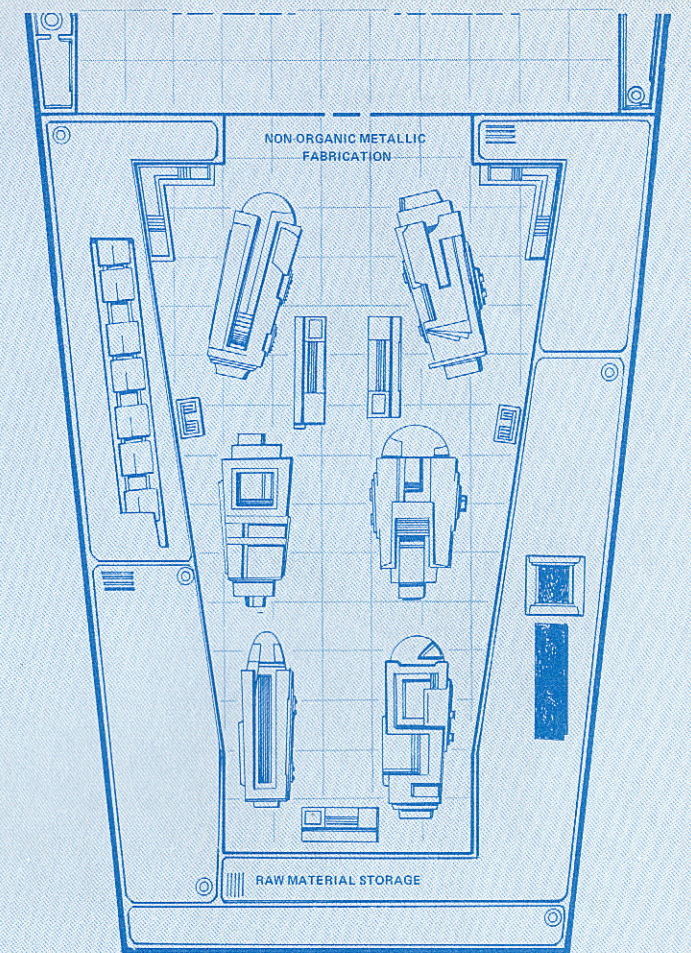

D-22 Fabrication Facilities



U.S.S. ENTERPRISE
 Constitution Class Heavy Cruiser
 Sheet 9 of 9 Side B

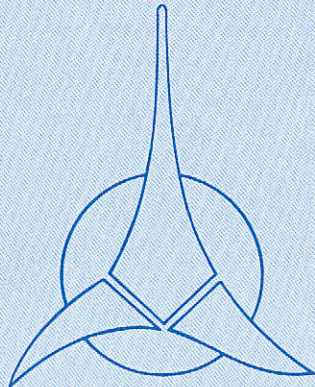

KLINGON

D-7 Class Battle Cruiser

Sheet 1 of 6 Side A

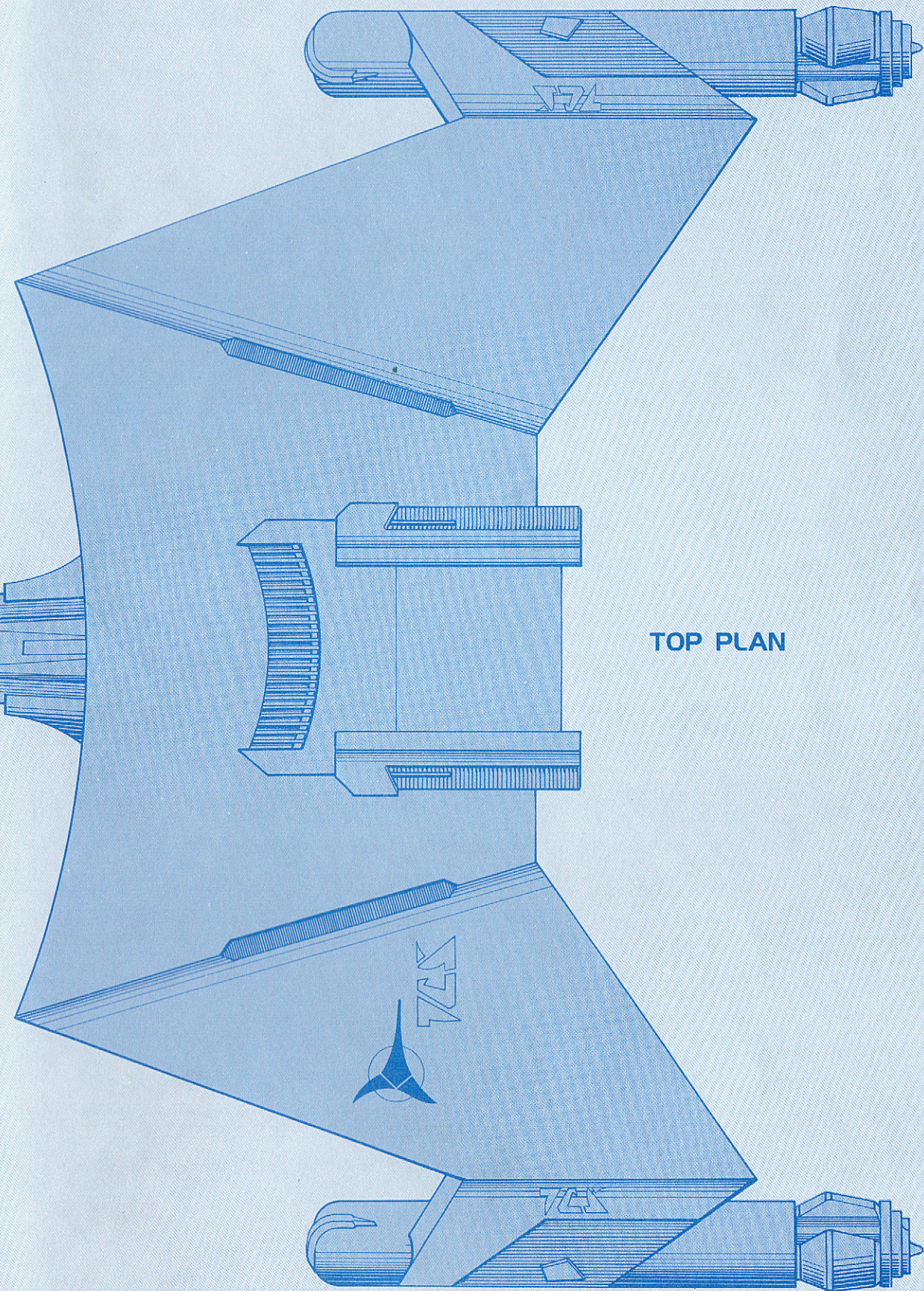
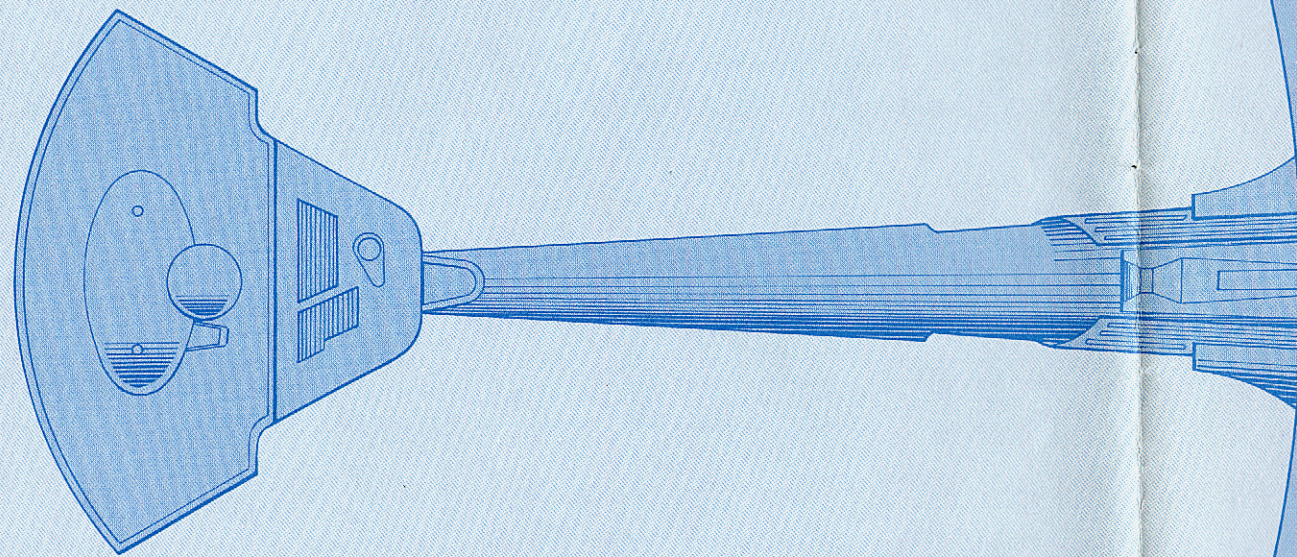

TOP PLAN

LEGEND

- | | | | | | | | |
|--|-----------------------------|--|-----------------------------------------------|--|----------------------------|--|---------------------------------|
| | Mess table and chairs | | Small desk | | Single bed with nightstand | | Bridge weapon's control console |
| | Standard table and chairs | | Shower stall | | Bunk bed | | Captain's chair |
| | Conference table and chairs | | Surgeon's operating tray and medical analyzer | | Intensive care bed | | Transporter console |
| | | | 2 man wardrobe | | Officer's desk | | Transporter disc |
| | | | Sink | | Chair | | |
| | | | Toilet | | | | |

The packet of plans was designed and drawn by FASA Corporation, P. O. Box 6930 Chicago, IL 60680

E-5 Crew Sick Bay/Crew Quarters

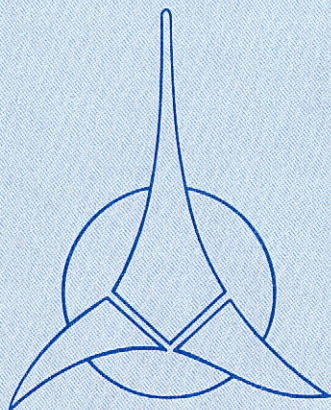
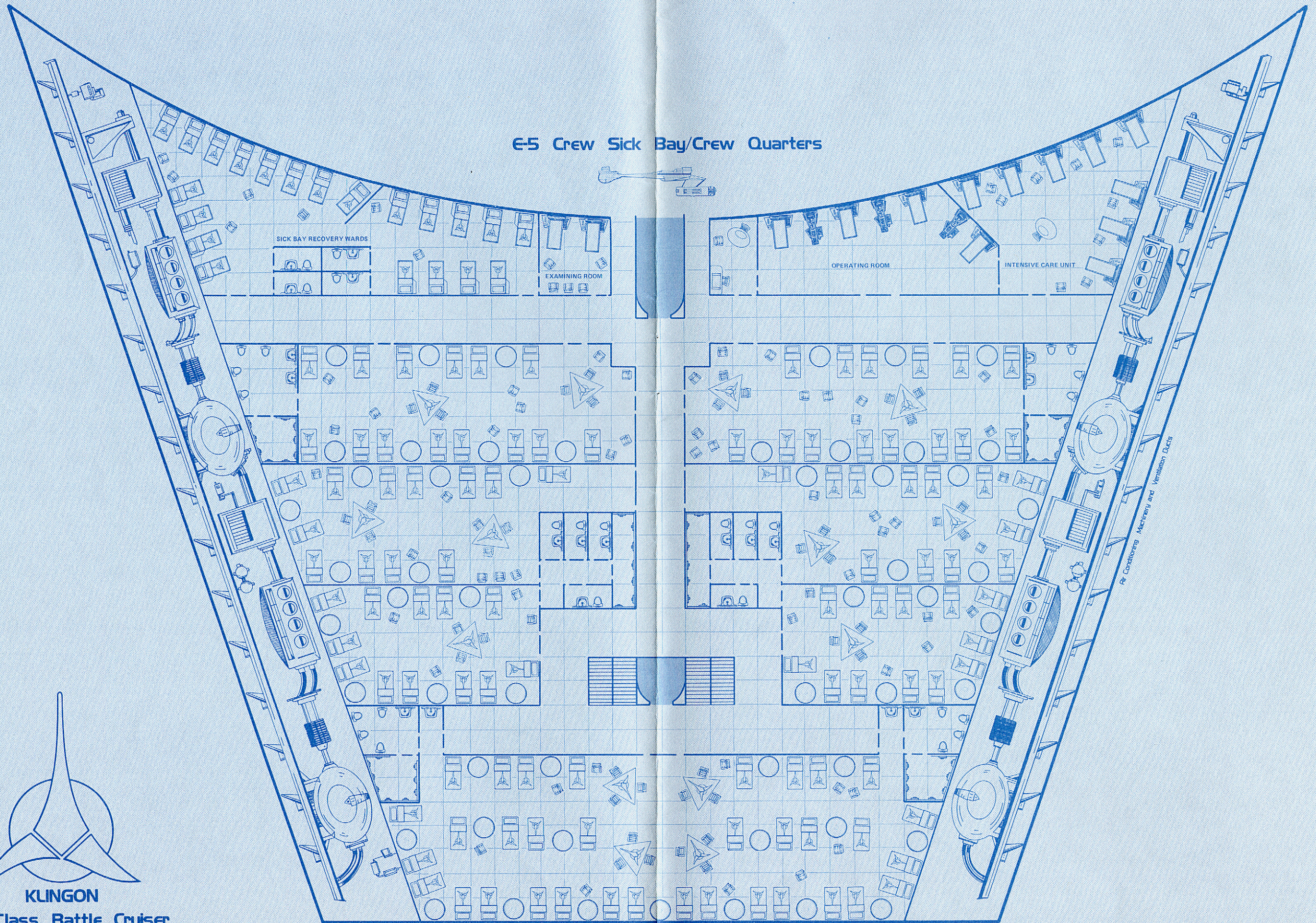

KLINGON

D-7 Class Battle Cruiser

Sheet 1 of 6 Side B

- D-0
SENSORS
- D-1
BRIDGE
- D-2
MEDICAL LABS
- D-3
SICK BAY
- D-4
OFFICES
- D-5
FOOD PREP. OFFICER'S MESS
- D-6
MAIN DECK
- D-7
SR. OFFICERS' QUARTERS
- D-8
JR. OFFICERS' QUARTERS
- D-9
INTELLIGENCE
- D-10
MAIN SENSOR

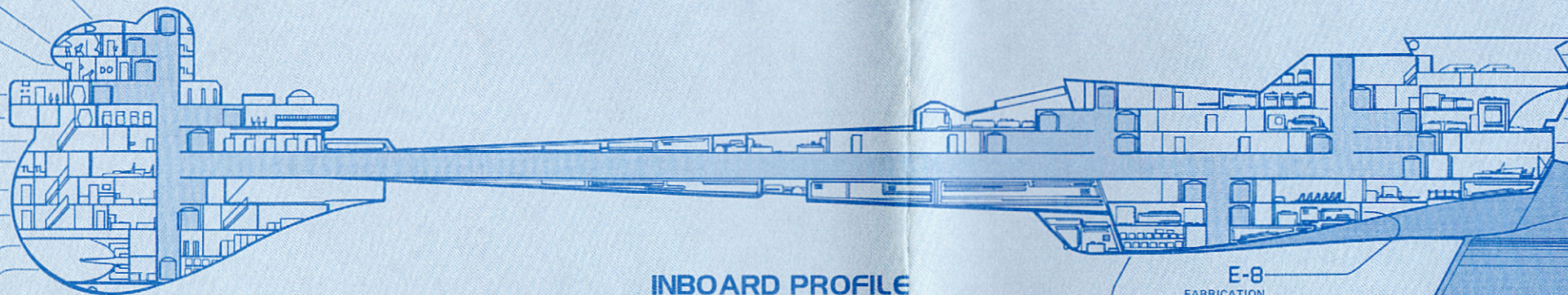

- E-1
HANGAR DECK
- E-2
SHUTTLE CRAFT MAINTENANCE
- E-3
ENGINEERING
- E-4
PETTY OFFICERS/ENGINEERING
- E-5
CREW QUARTERS AND SICK BAY
- E-6
MAIN DECK
- E-7
CREW RECREATION

- E-8
FABRICATION
- E-9
CARGO

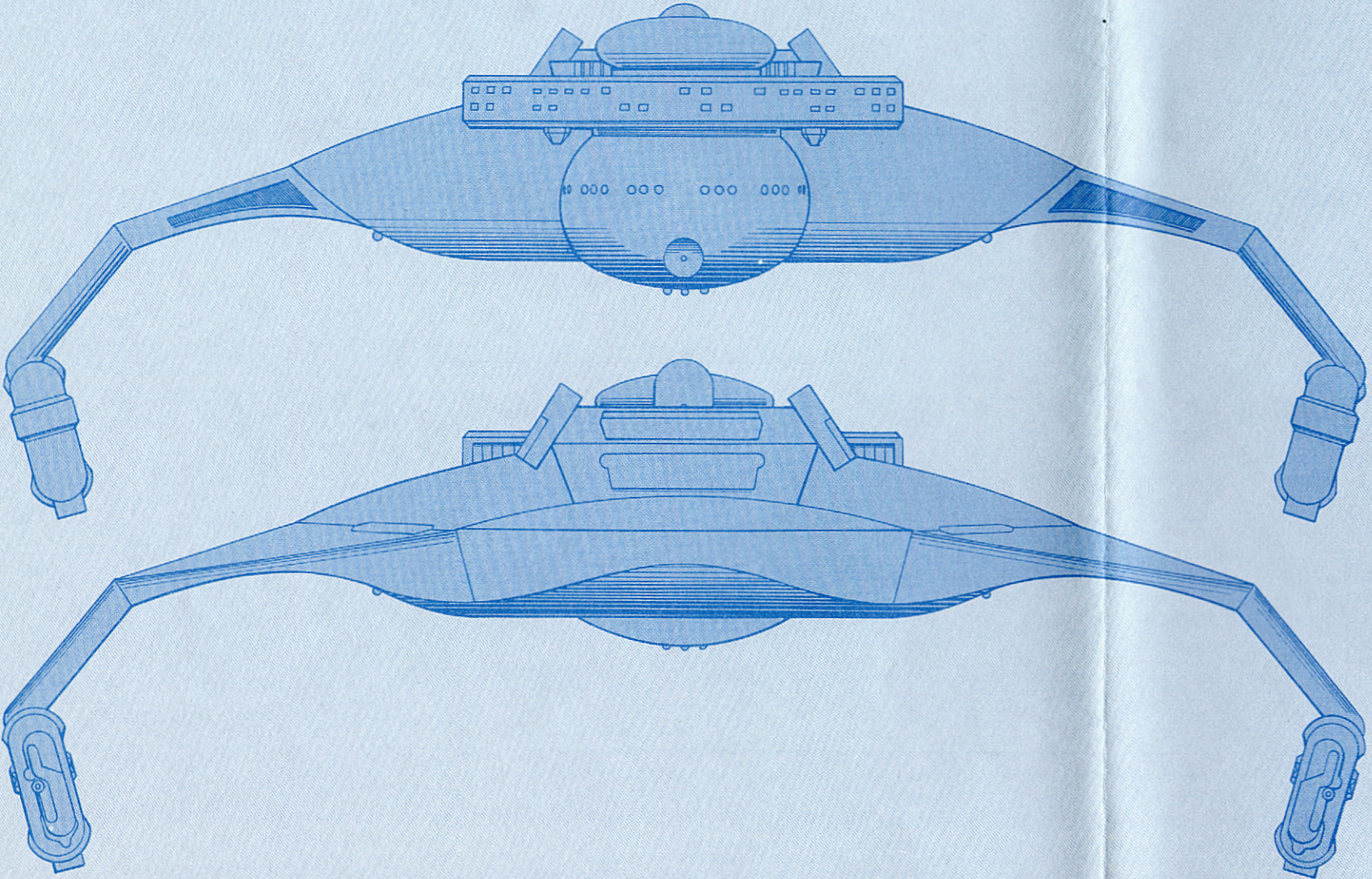
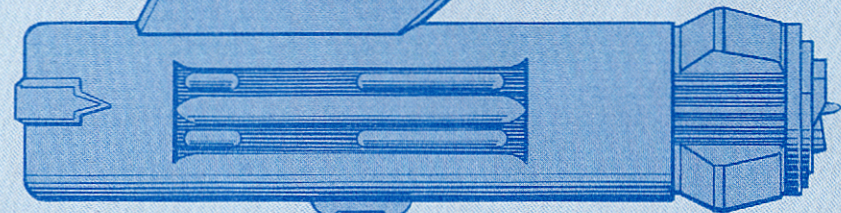

BOW ELEVATION

STERN ELEVATION

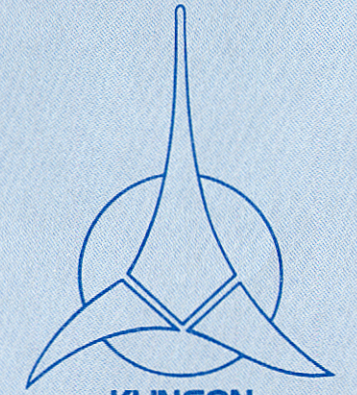

KLINGON
D-7 Class Battle Cruiser
 Sheet 2 of 6 Side A

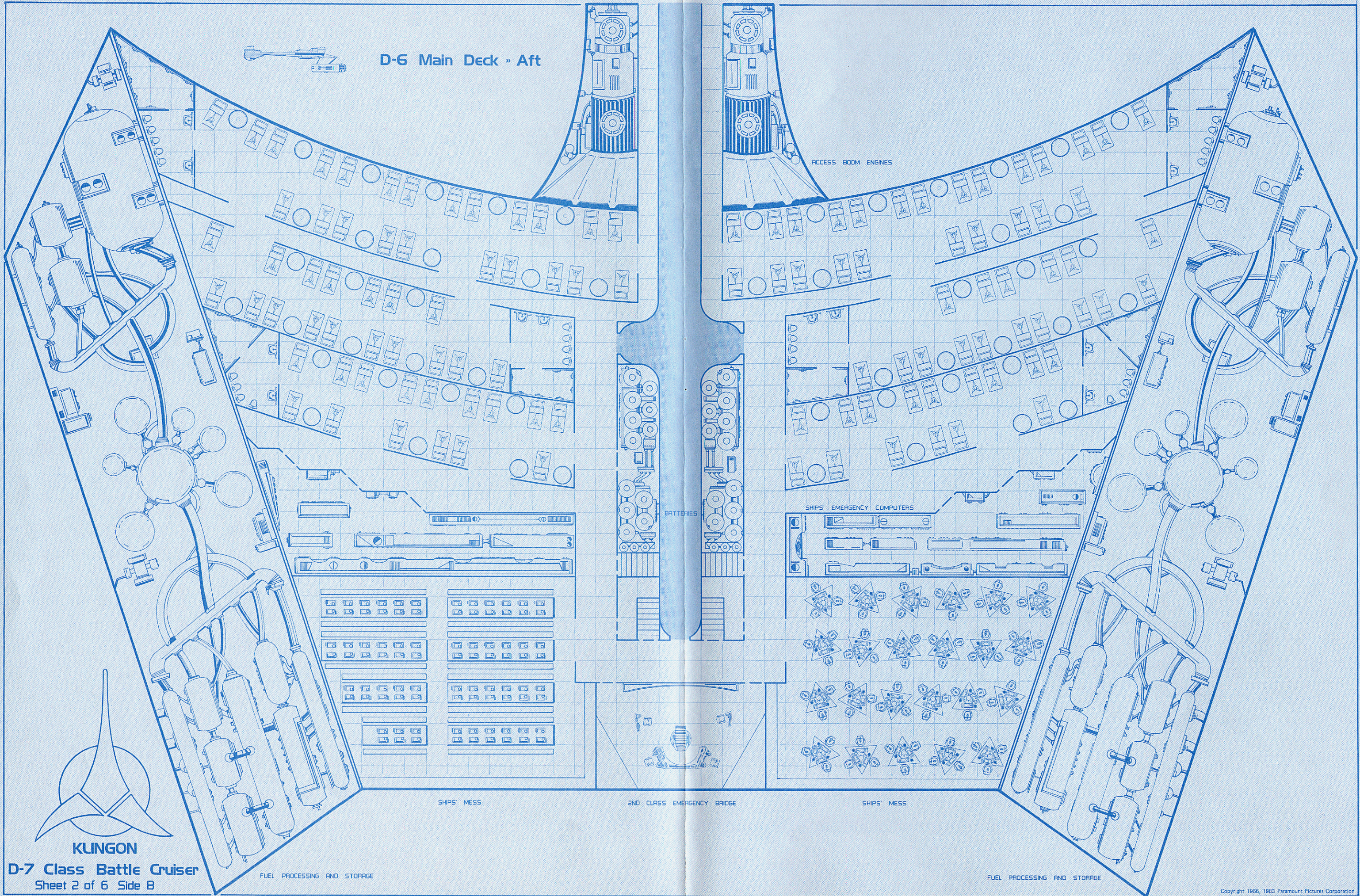

D-6 Main Deck » Aft

ACCESS BOOM ENGINES

BATTERIES

SHIP'S EMERGENCY COMPUTERS

SHIP'S MESS

2ND CLASS EMERGENCY BRIDGE

SHIP'S MESS

FUEL PROCESSING AND STORAGE

FUEL PROCESSING AND STORAGE

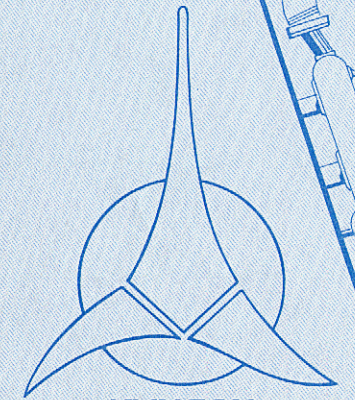

KLINGON

D-7 Class Battle Cruiser

Sheet 2 of 6 Side B

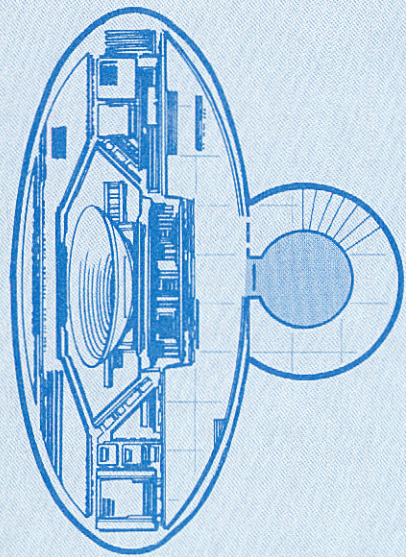

D-0 Secondary Sensors

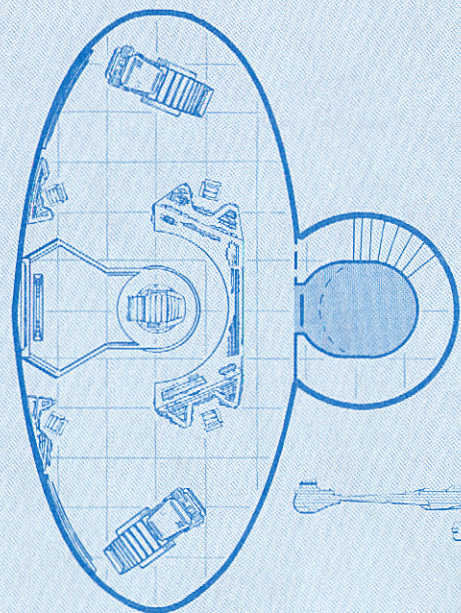

D-1 Bridge

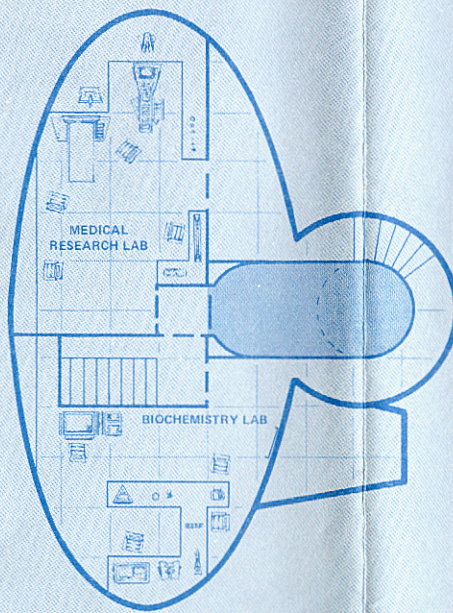

D-2 Medical Labs

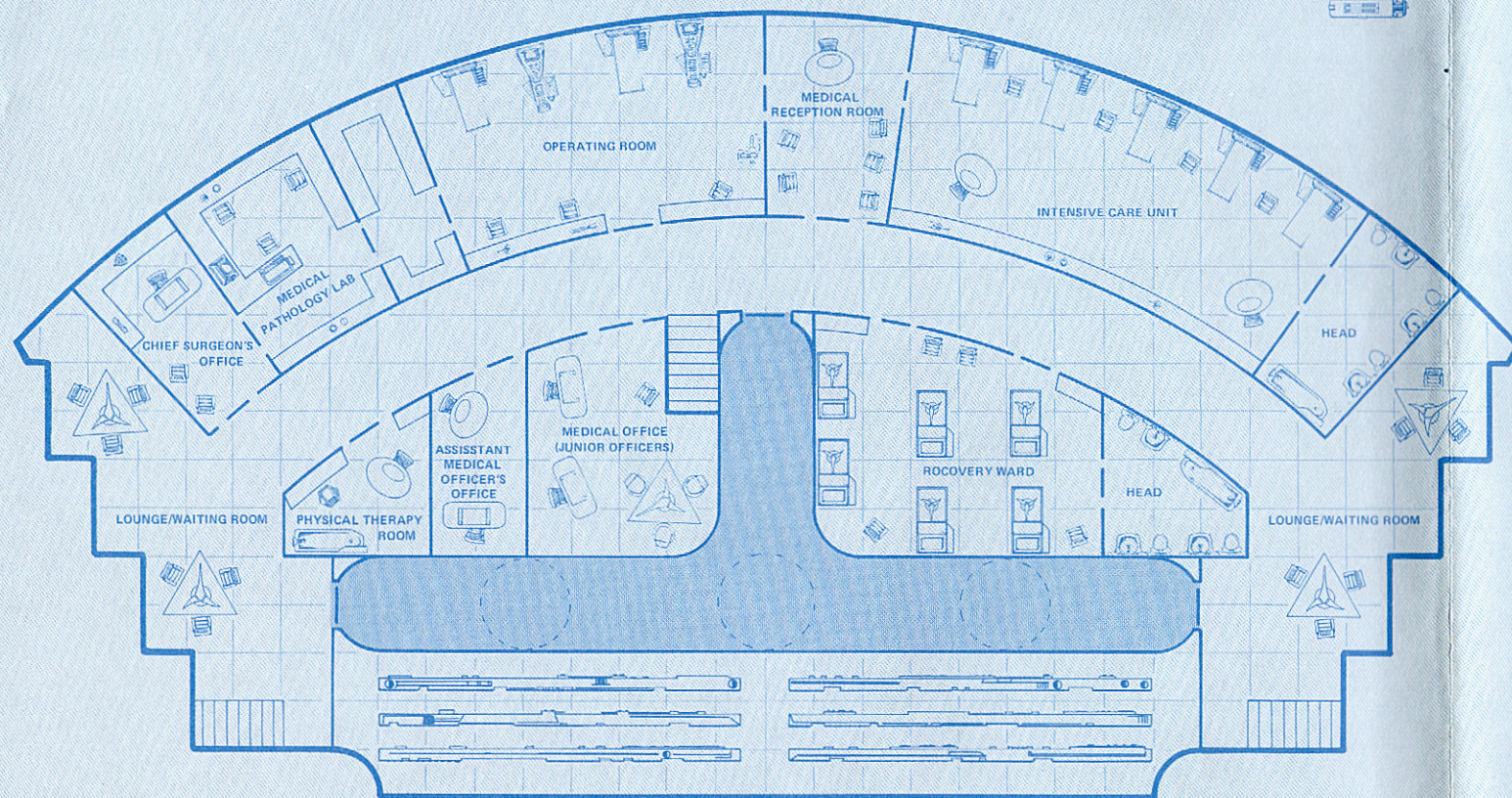

D-3 Officers' Sick Bay

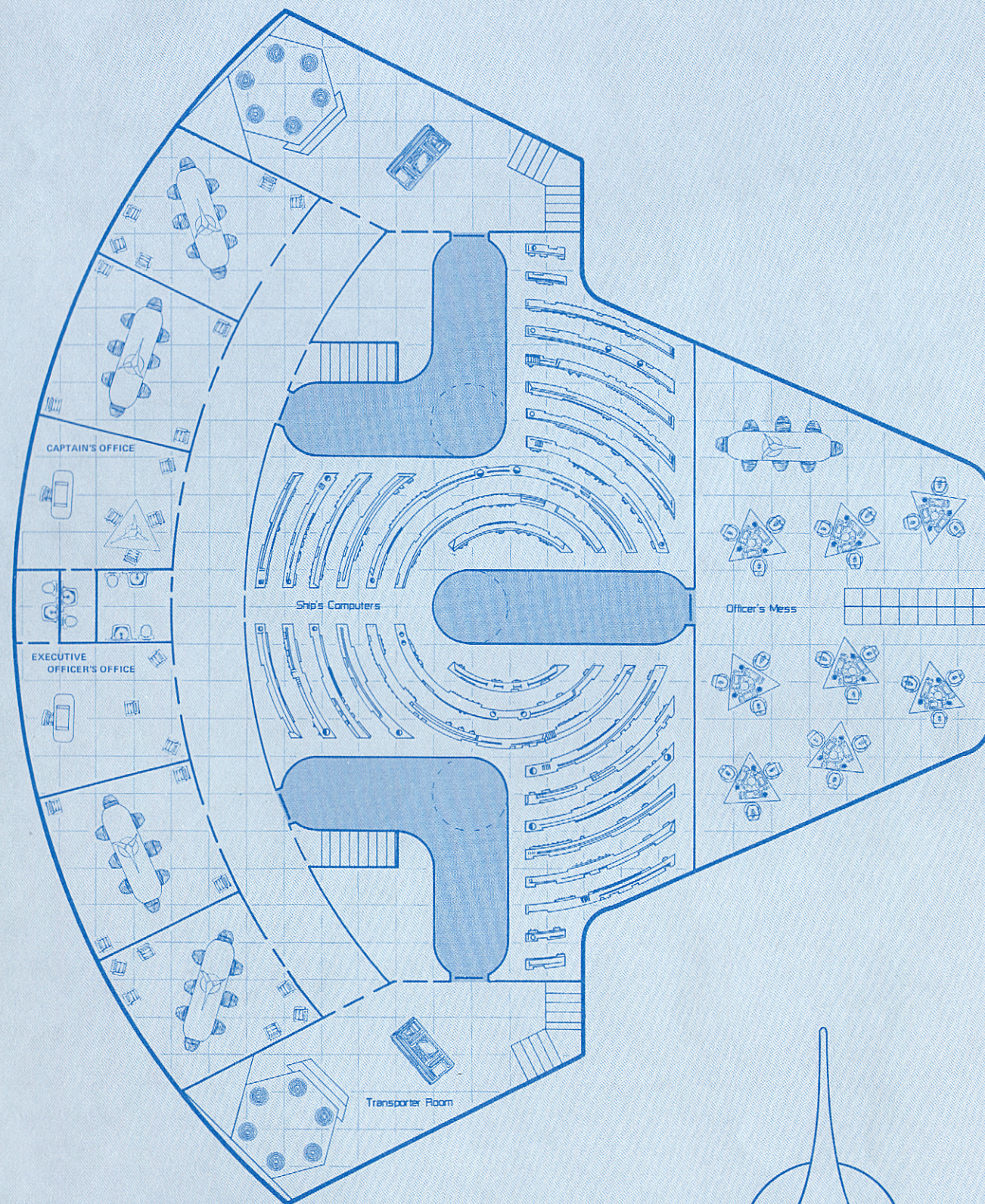

D-4 Offices Ships Computer

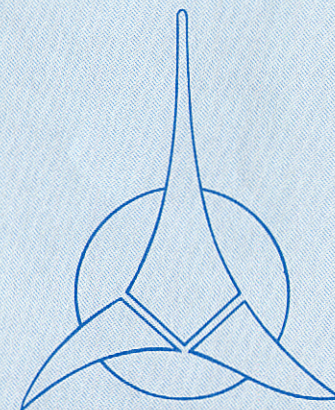
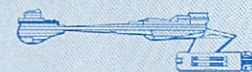

KLINGON

D-7 Class Battle Cruiser

Sheet 3 of 6 Side A

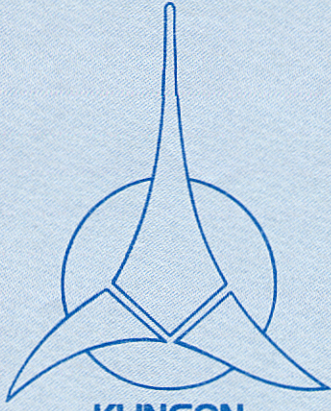

KLINGON

D-7 Class Battle Cruiser

Sheet 3 of 6 Side B

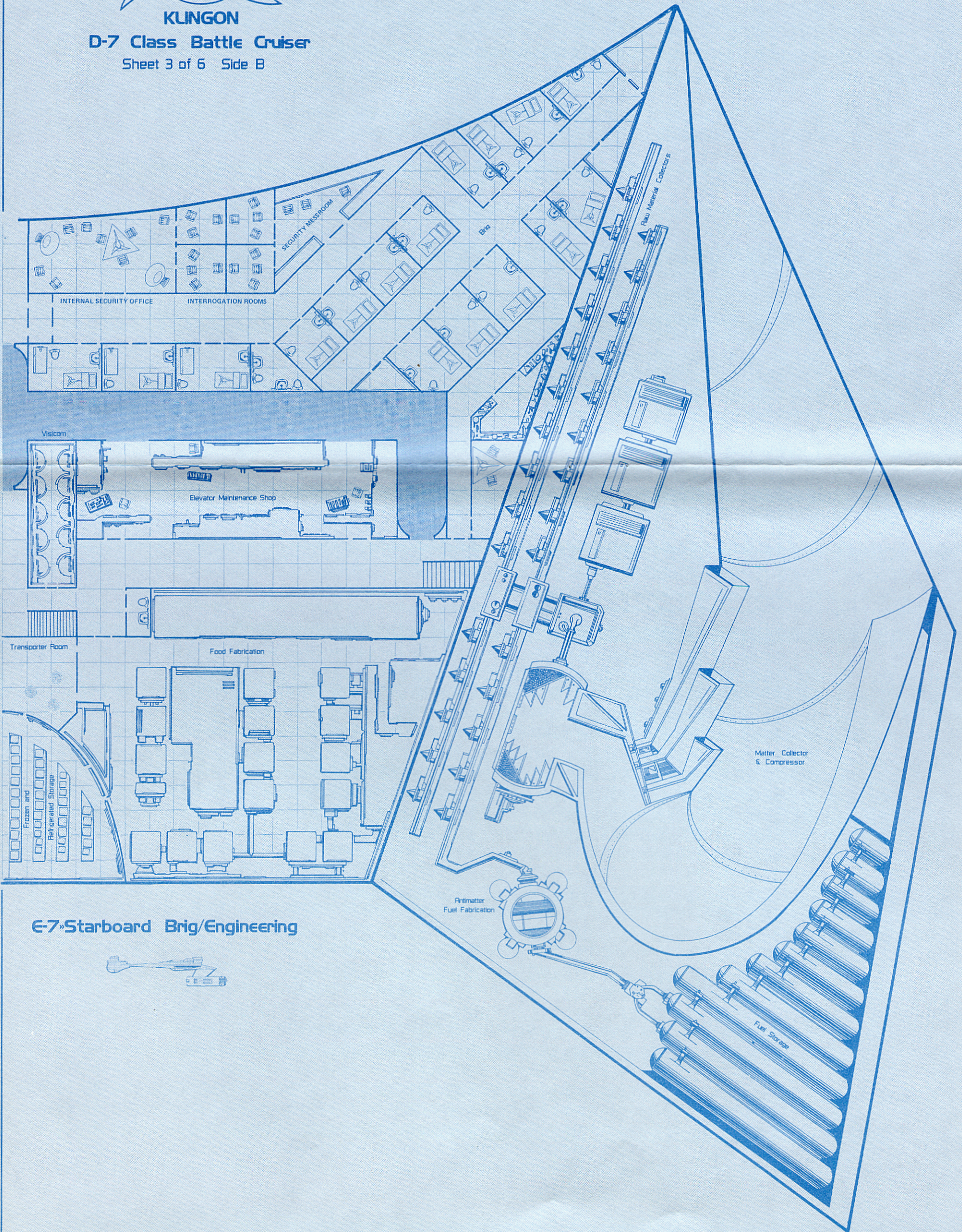

E-7 Starboard Brig/Engineering



Manual Food Preparation

D-5 Food Preparation

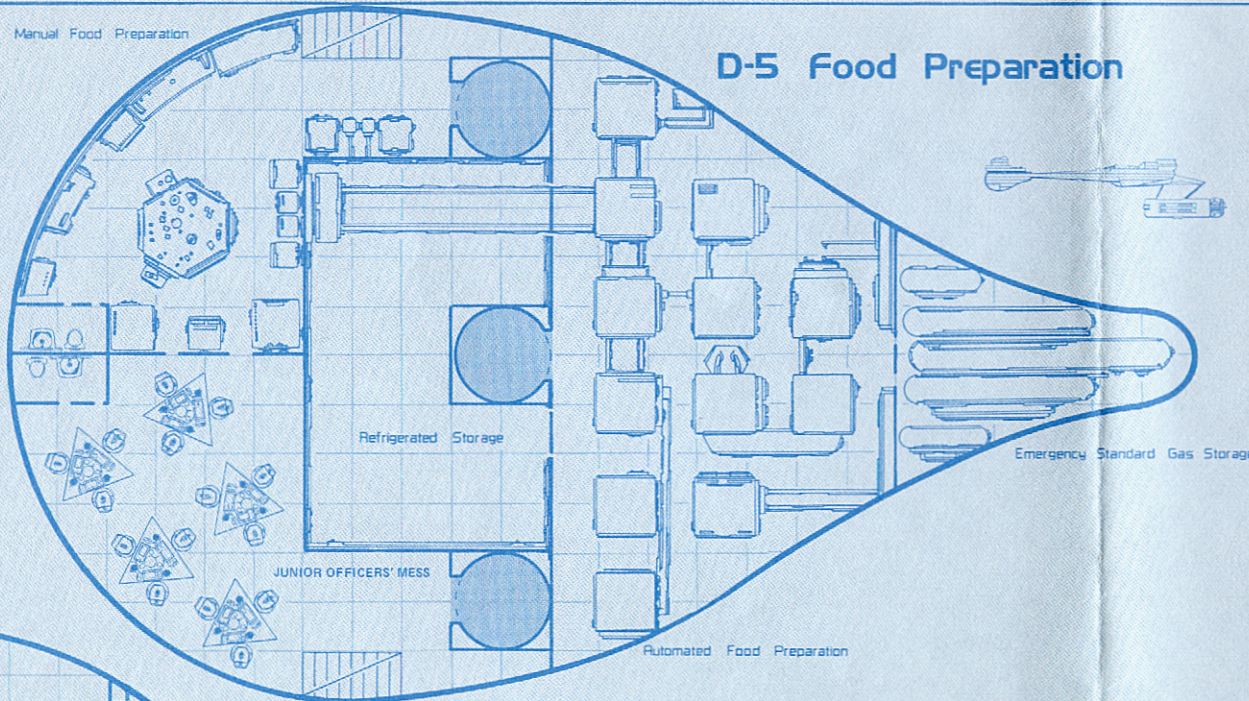

D-8 Junior Officers' Quarters

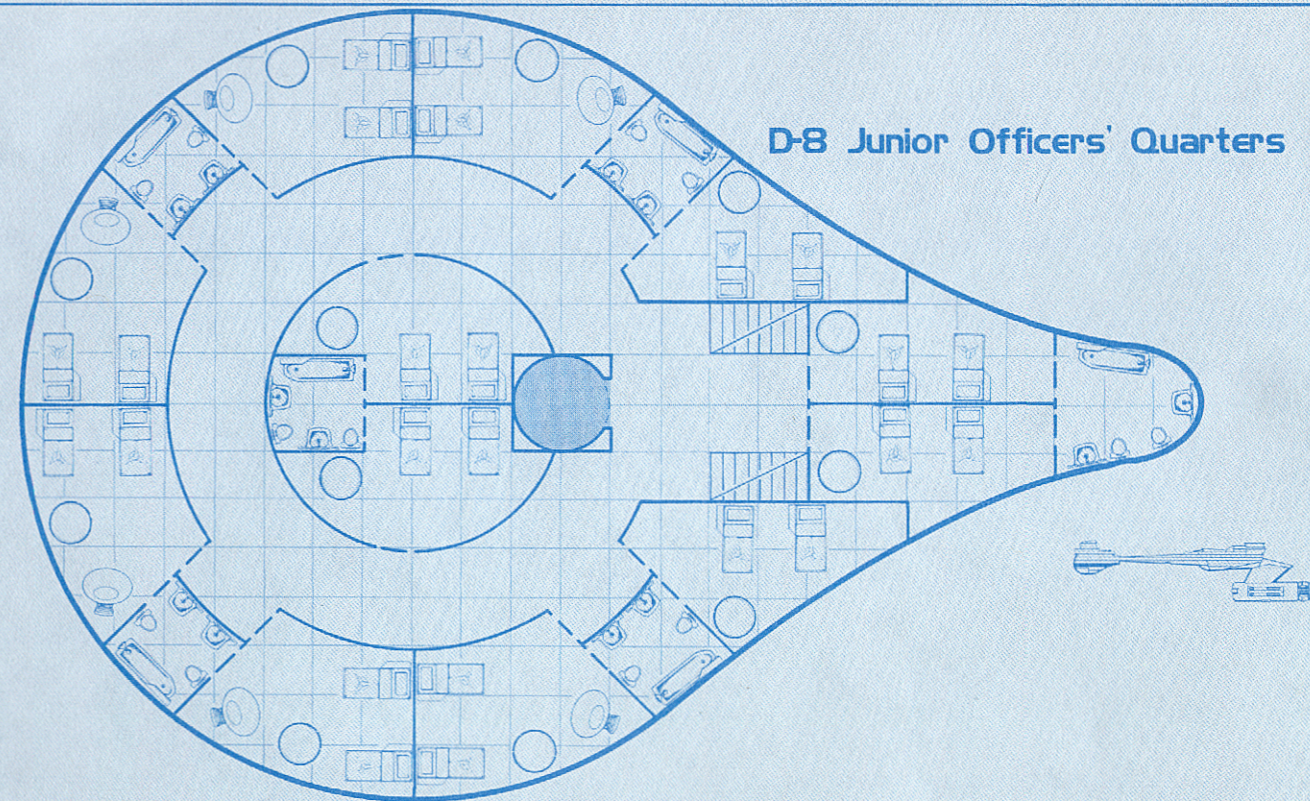

D-6 Main Deck » Forward

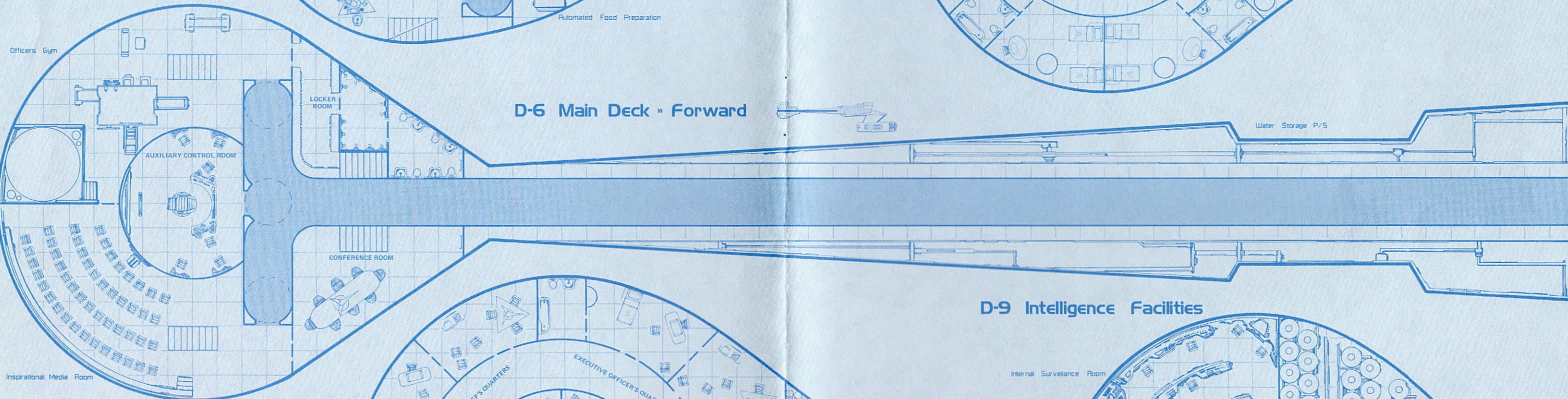

D-9 Intelligence Facilities

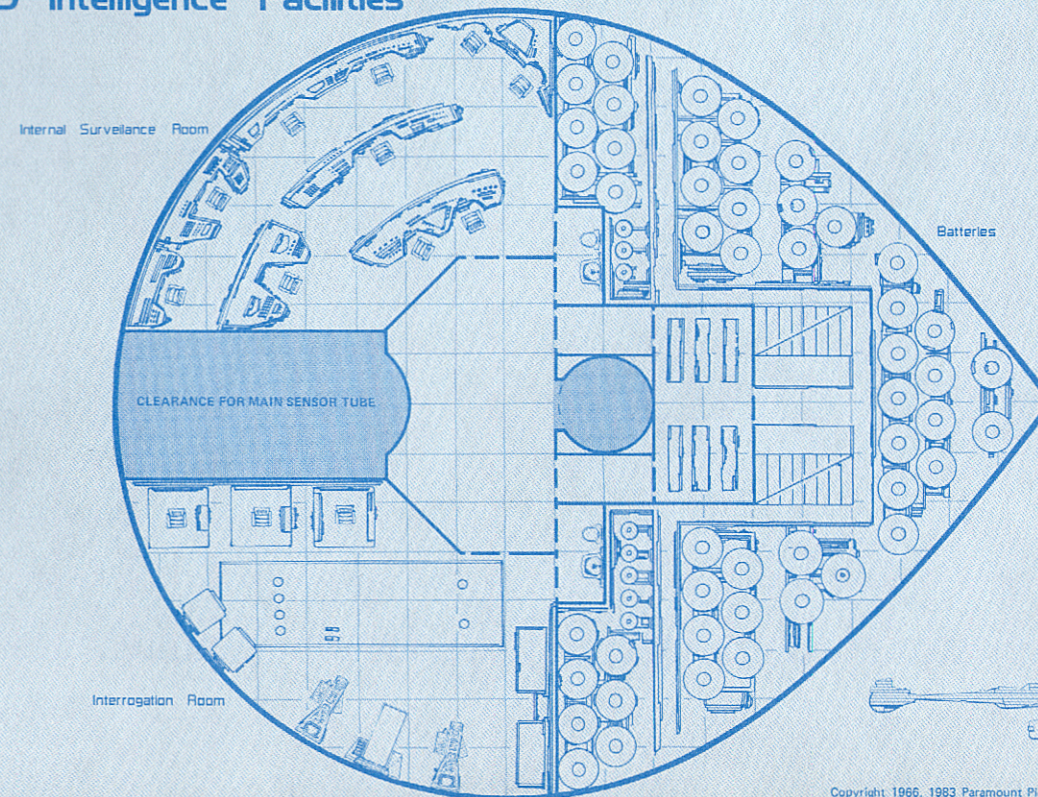

D-7 Senior Officers' Quarters

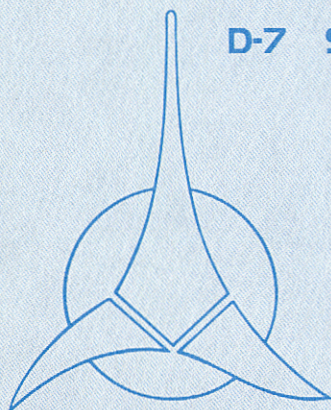
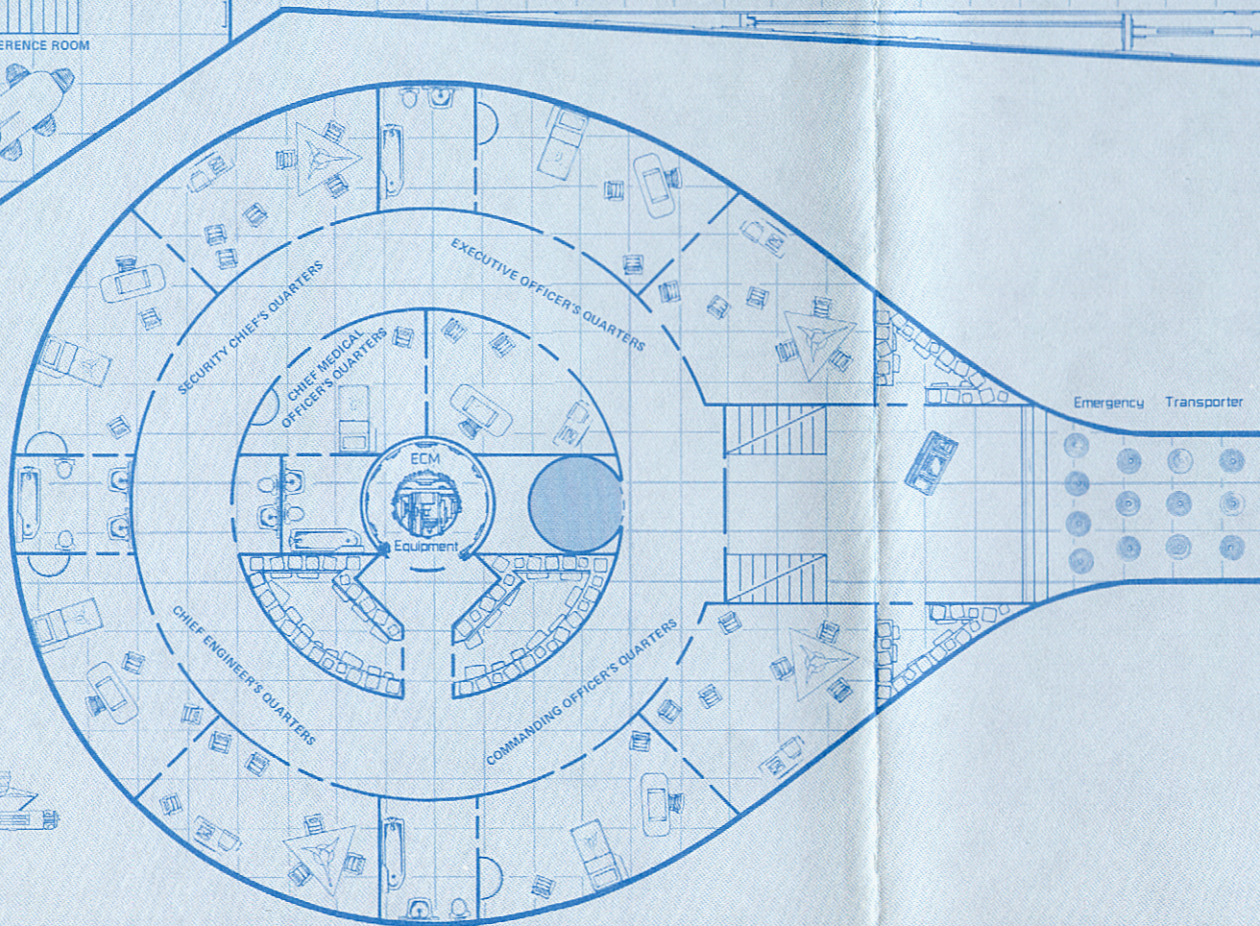

KLINGON

D-7 Class Battle Cruiser

Sheet 4 of 6 Side A

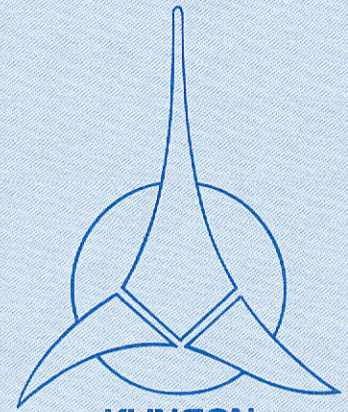

KLINGON

D-7 Class Battle Cruiser

Sheet 4 of 6 Side B

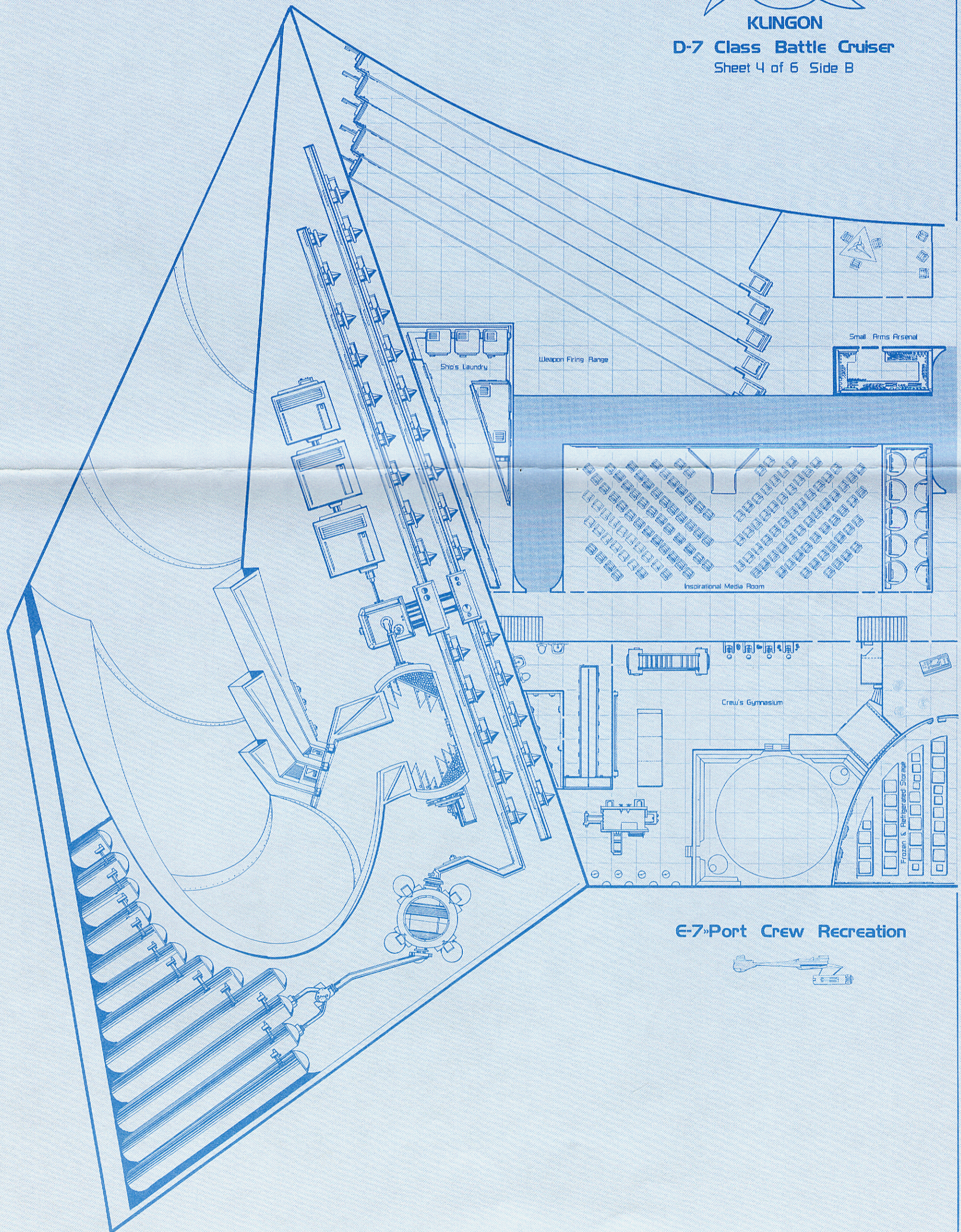

E-7 Port Crew Recreation



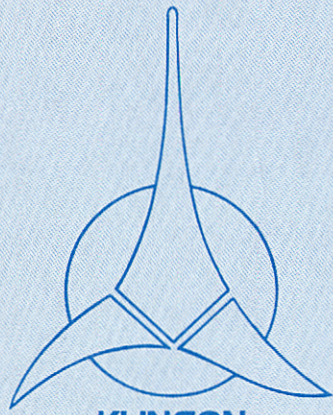

KLINGON

D-7 Class Battle Cruiser
Sheet 5 of 6 Side A

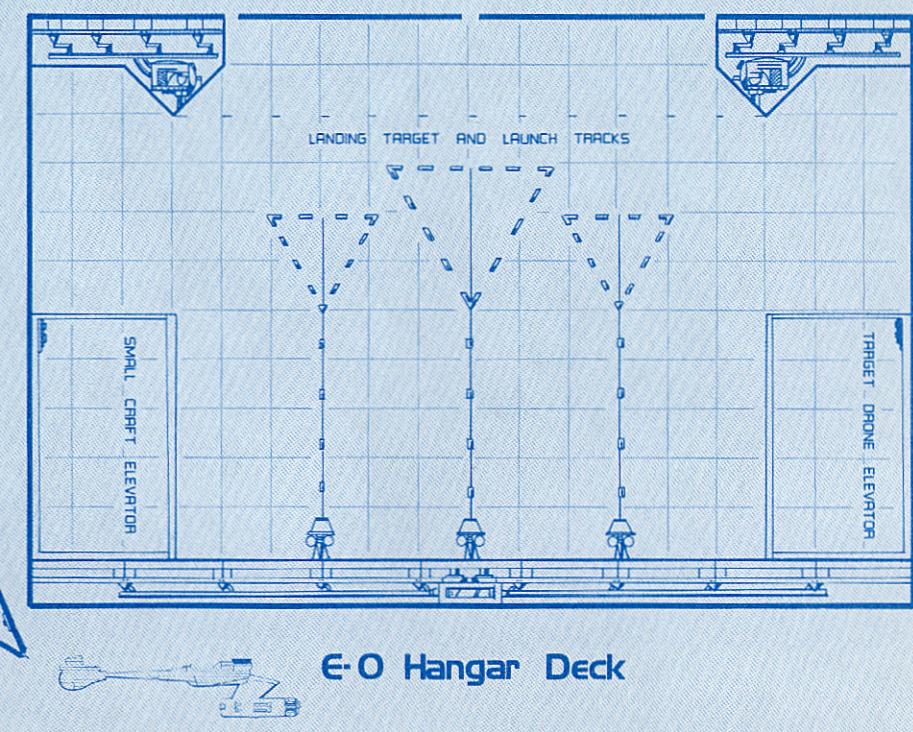
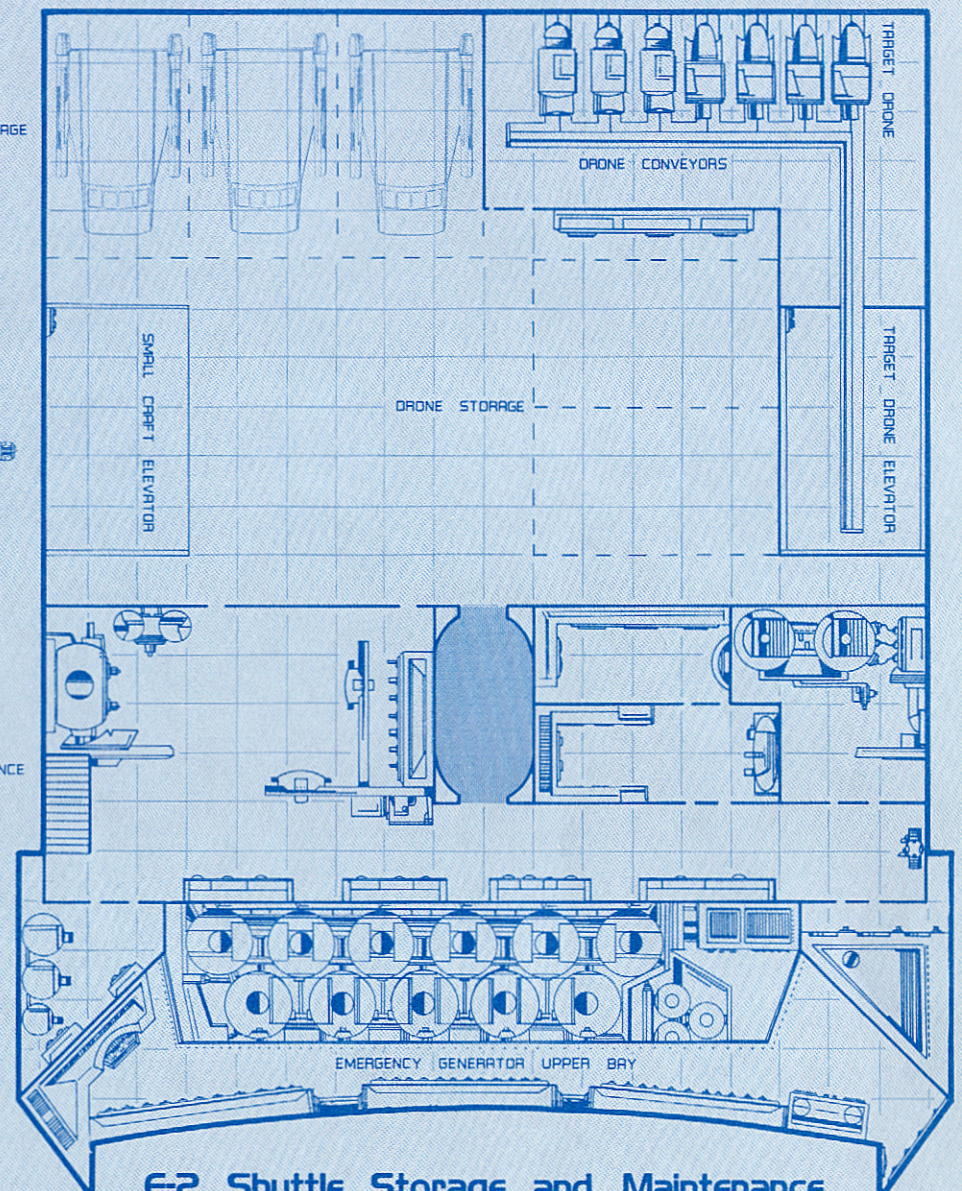
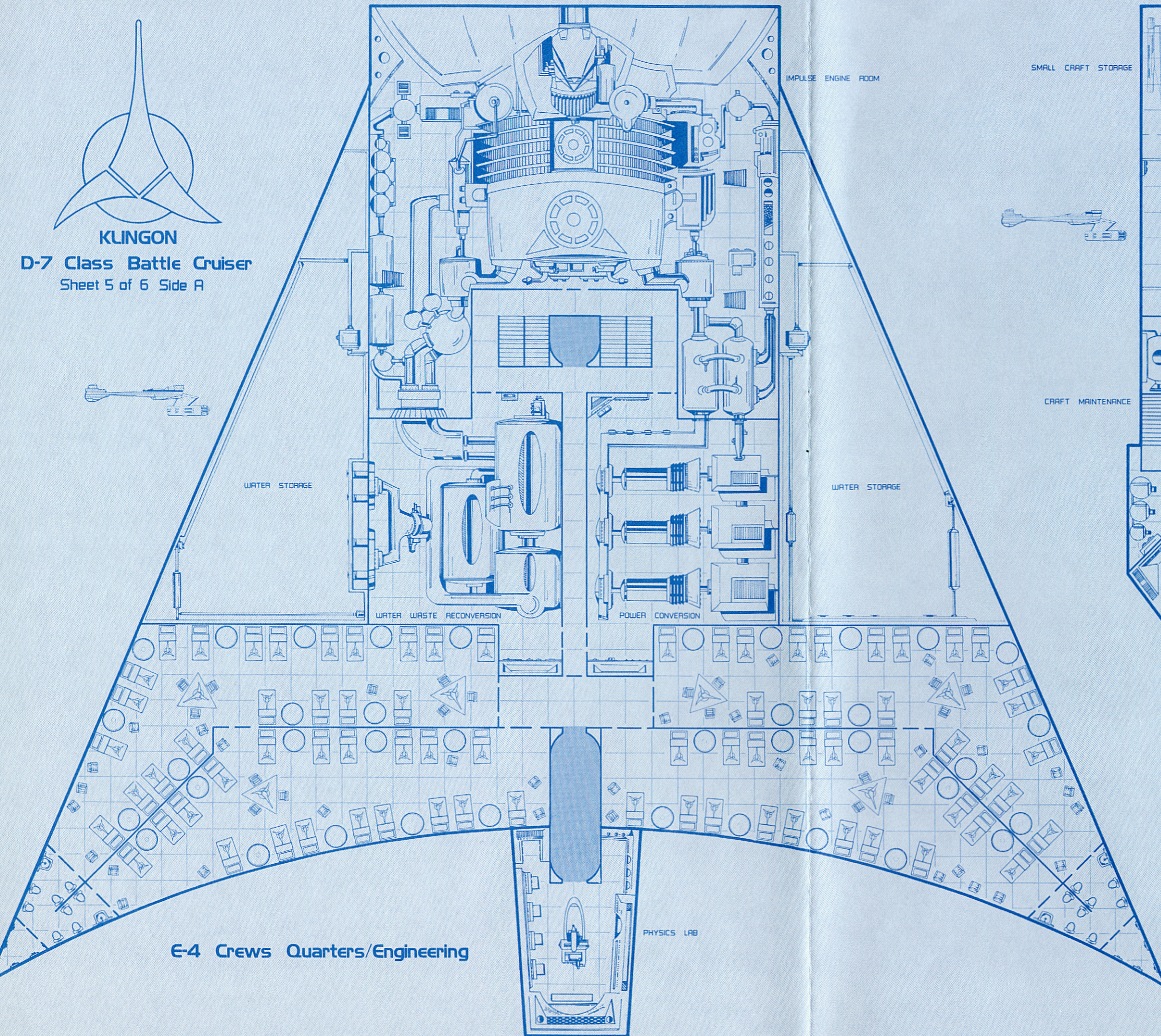

E-8 Fabrication Transporters

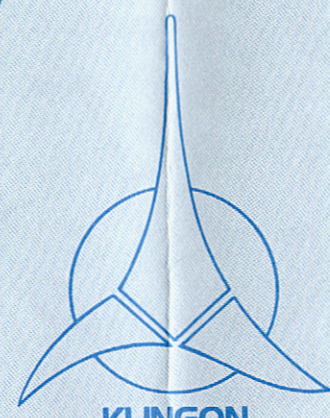
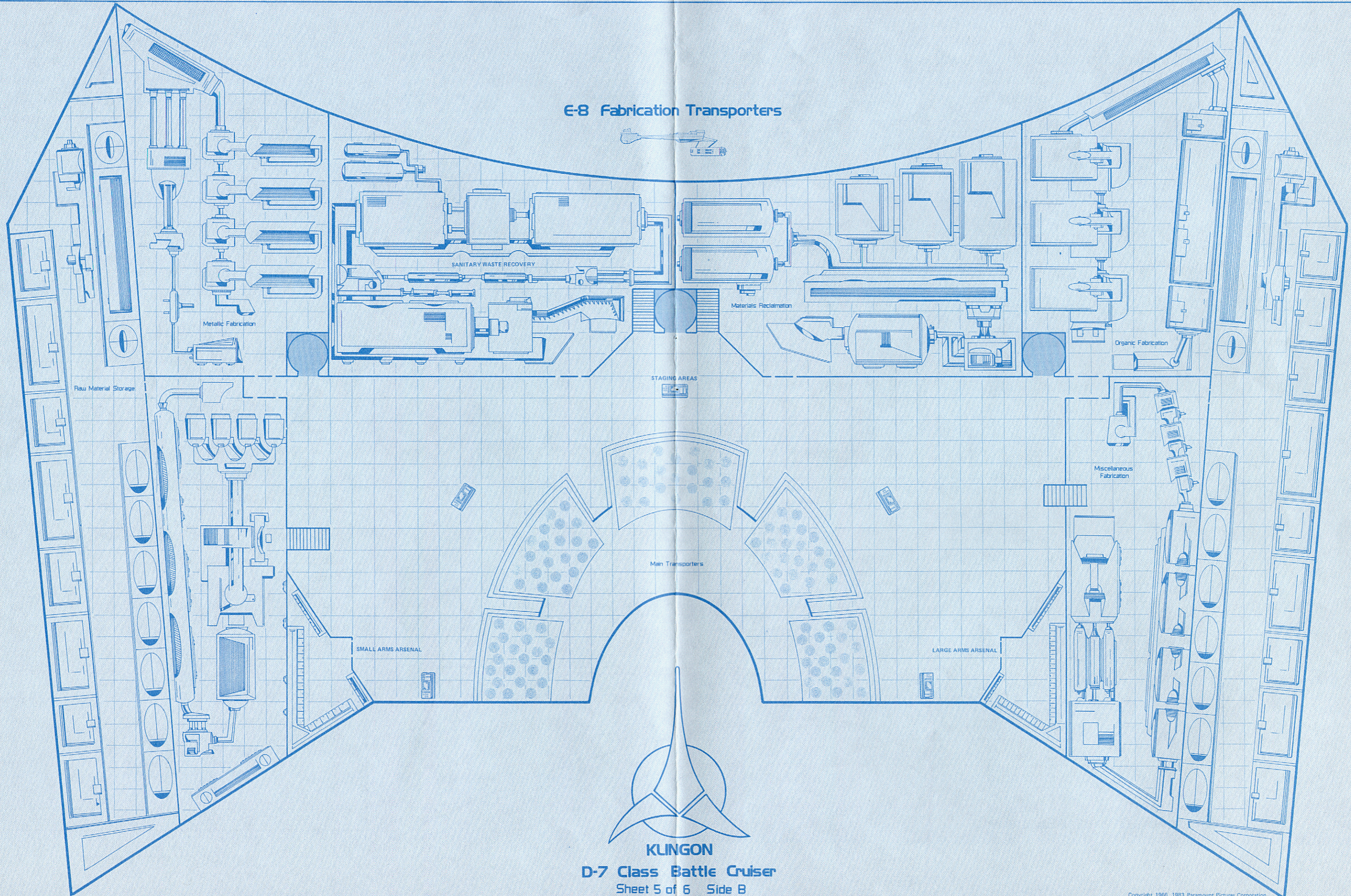

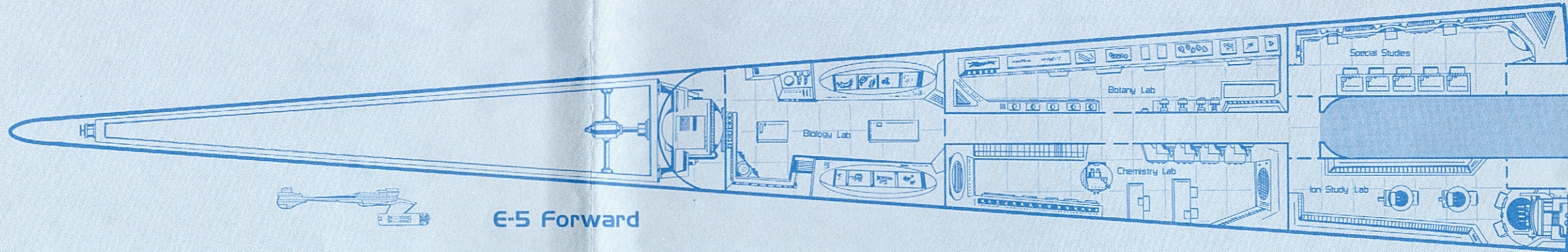

E-5 Forward

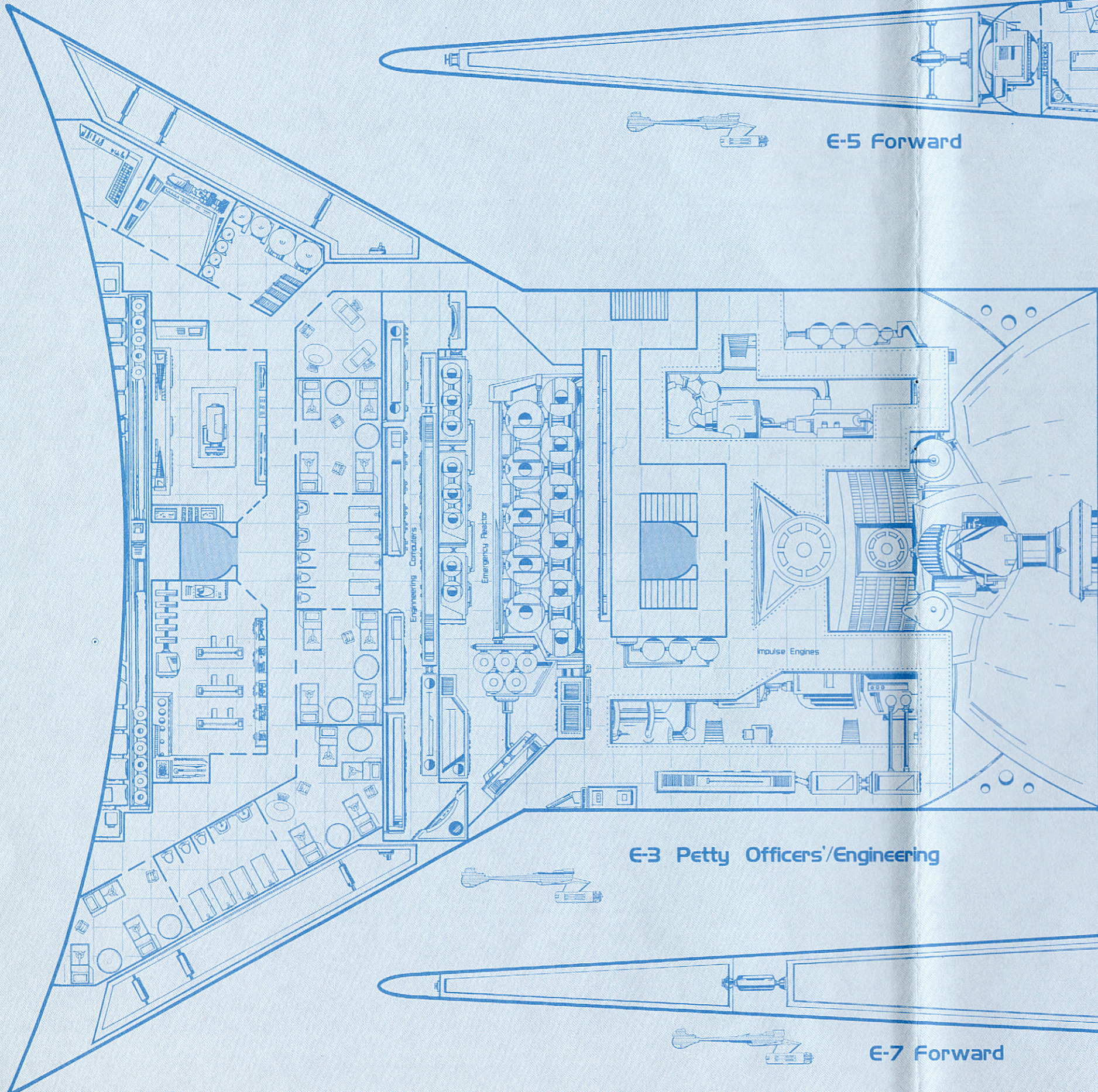

E-3 Petty Officers/Engineering

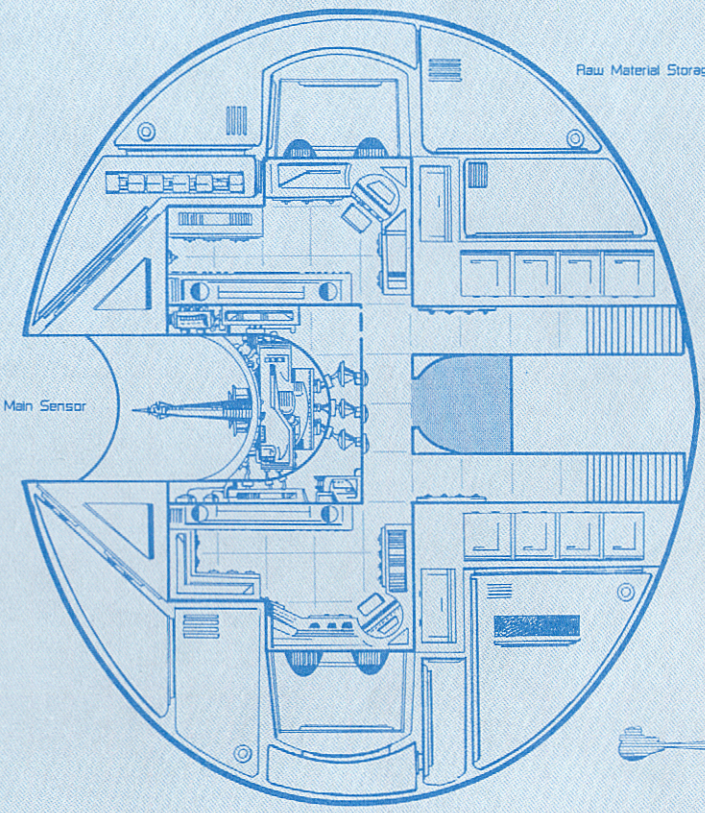

D-10 Main Sensor

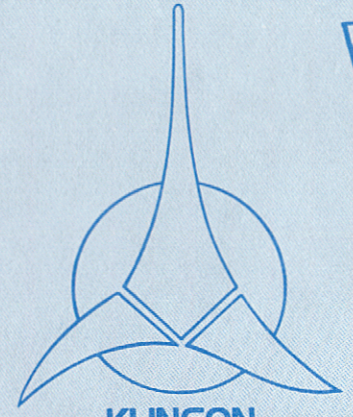

KLINGON

D-7 Class Battle Cruiser

Sheet 6 of 6 Side A

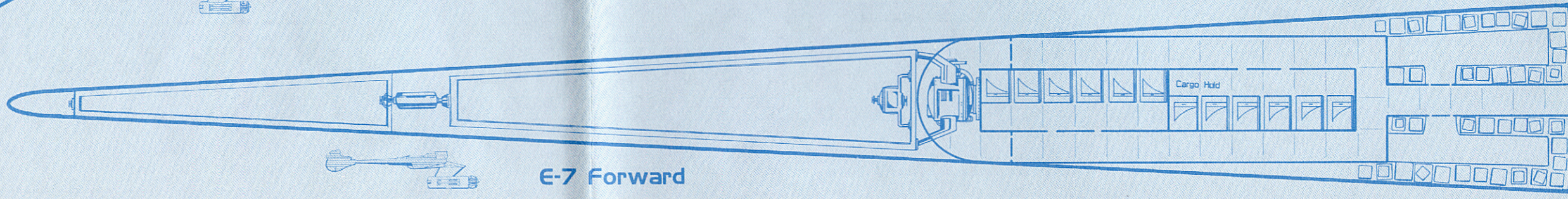

E-7 Forward

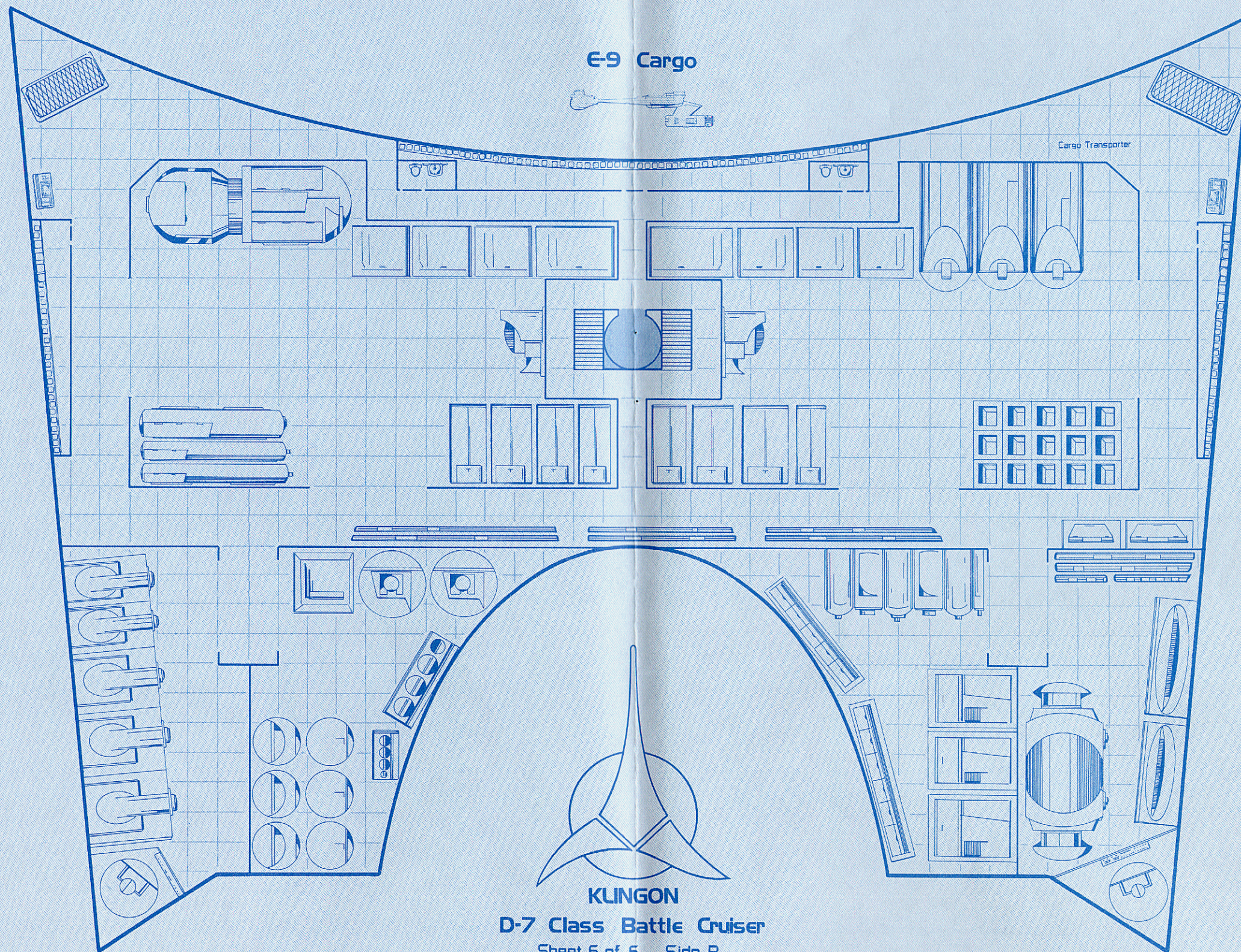



Space ... the final frontier.

These are the voyages of the Starship Enterprise.

Its five-year mission: to explore strange new worlds, to seek out new life and new civilizations to boldly go where no man has gone before...

Now you can join the Enterprise; all that is required is right here. Included in the game is:

1. **The Basic Rule Book:** This 128-page, two-color, 8½ x 11 inch book contains all of the rules needed to create and play a Star Fleet character. Rules for man-to-man combat, starship combat, planetary generation, and culture and alien generation are also included. This book is heavily illustrated with pictures from the TV series.
2. **Adventure Book:** This 48-page, 8½ x 11 book contains three introductory adventures and descriptions of the Enterprise and Klingon D-7 deck plans.
3. **Deck Plan Book:** This 80-page, 8½ x 11 inch pull-apart book contains scaled deck plans of the U.S.S. Enterprise and the Klingon D-7 class Battlecruiser. The scale of these plans is 1 inch = 6 meters. Also included with this book are several reference sheets used with the starship combat system.
4. **Starship Combat Hex Grid:** This 22½ x 33 inch hex grid is used with the starship combat system.
5. **112 Illustrated Counters:** One side of these counters is used with the starship combat system. The other side depicts figures and can be used with man-to-man combat.
6. **Two 20-sided dice.**

FASA Corporation, P.O. Box 6930 Chicago, IL 60680

