

A supplement for use with

STAR TREK
THE ROLE PLAYING GAME

2002A

T·H·E KLINGONS



FASA
CORPORATION

GAME · OPERATION · MANUAL

TABLE OF CONTENTS

INTRODUCTION	3
How to Use This Book	3
DESIGNING KLINGON ADVENTURES	4
Mainstream Designs	4
Pre-War Adventures	4
Four Years War Adventures	4
Post-War Adventures	4
Late History Adventures	5
Civilian Character Adventures	5
Klingon-Based Adventures	6
Planetside Adventures	6
Klingons vs. Romulans	7
Organian Treaty Zone Adventures	7
Klingon Neutral Zone	8
THE KLINGON EMPIRE	9
Extent of the Empire	9
The Four Quadrants	9
Noteworthy Planets	12
KLINGON HISTORY	18
Early History	18
Kobek Conquest	19
Unification	19
Early Expansion	20
The Romulan Enemy	20
Growth Of An Empire	21
Enter The Federation	22
The Demon War	23
The Four Years War	24
Post-War Period	24
Organian Conflict	25
Klingon/Romulan Accords	26
Decline of Fusion Influence	26
TIMELINE	27
KLINGON HOME SYSTEM	32
Klinzai	32
Major Cities	32
Kobek	33
INTERSTELLAR RELATIONS	34
United Federation of Planets	34
The Four Years War	34
The Organian Conflict	35
Romulan Star Empire	36
Exchange Agreements	37
Current State of Affairs	37
Orion Colonies	38
Imperial Klingon States	38
Gorn Alliance And Tholian Assembly	38
Kinshaya	39
THE KLINGON PEOPLE	40
Genetic Engineering	40
Imperial Klingons	40
Fusion Races	40
The Klingon Personality	41
Psionics	42
Klingon Paranoia	42
Religion, Myth, And Legend	43
Komerex Zha, The Great Game	43
Government	44
The Emperor	44
Imperial Council	45
Imperial Hands	45

KLINGON ARMED FORCES	46
Imperial Navy	46
Organization	46
Naval Branches	46
Rank, Position, Title	48
Chain of Command	49
Uniforms	49
Starship Recognition File	50
The Imperial Marines	52
Organization	52
Rank, Position, Title	52
Chain of Command	52
Uniforms, Insignia, and Decorations	52
Marine Tactics	52
ICB/KDC	52
CREATING KLINGON PLAYER CHARACTERS	54
Defining Klingon Characters	54
Attributes	54
Skills	54
Generating Klingon Characters	56
Assigned Ship, Rank, Position	56
Choosing A Race	56
Creating Attribute Scores	56
Creating Endurance Statistics	57
Character Aging	57
TRAINING PLAYER CHARACTERS	58
Pre-Academy Skills	58
Imperial Star Academy	59
Three Phases of Training	59
Specialty Skills	61
Skill Application	63
Advanced Training	64
Leaders of Men	64
Leaders of Vessels	64
Service Experience	65
Tours of Duty Served	65
Tour Assignment and Length	66
Service Skill Rolls	66
Combat Statistics	67
Action Points (AP)	67
Base To-Hit Numbers	67
Bare-Hand Damage	67
Character Age	67
GAMEMASTERING KLINGON ADVENTURES	68
Hints for Play	68
Getting Started	68
Starship Encounters	68
Klingon Imperial Policy	69
The Paranoia Factor	69
The Plot Thickens	70
Judging Ground Action	71
Injury, Death, and Medical Aid	71
Judging Equipment	73
Personal Equipment	73
Medical Equipment	73
Drugs and Toxins	74
Weapons	74
Shipboard Systems	75
Creating Typical Klingon NPCs	75
Attributes	75
Significant Skills	76
DESIGNER'S NOTES	77



THE KLINGON EMPIRE

Design:

Fantasimulations Associates
Guy W. McLimore, Jr.
Greg K. Poehlein
David F. Tepoch

Writing:

Fantasimulations Associates
(based on original material by John M. Ford)

Additional writing:

Donna Ippolito
Todd Huettel

Continuity:

Forest G. Brown
C. W. Hess
Josh W. Spencer

Editorial Staff

Editor-In-Chief
L. Ross Babcock III
Senior Editor
Donna Ippolito
Editor
Todd Huettel

Production Staff

Production Manager
Jordan K. Weisman
Art Director
Dana Knutson
Cover Design
Jeff Laubenstein
Illustration
Todd F. Marsh
Dana Knutson
Jeff Laubenstein
Mitch O'Connell
Typesetting and Layout
Tara Gallagher
Pasteup
Todd F. Marsh
Dana Knutson

STAR TREK is a Registered Trademark of Paramount Pictures Corporation.
STAR TREK: The Role Playing Game is published by FASA Corporation
under license from Paramount Pictures Corporation, the trademark owner.
Copyright © 1987 Paramount Pictures Corporation.
All Rights Reserved. Printed in the United States of America.

Published by FASA Corporation
P.O. Box 6930
Chicago, IL 60680

INTRODUCTION

It is impossible to imagine what *STAR TREK* would have been like without the Klingons. Just as Tom Sawyer needed Injun Joe and Holmes required the contrast of Moriarty, Captain Kirk would not be the same without Kang, Koloth, Kor, and their kin.

In *STAR TREK*, however, the Klingons were more than just a foil for the good guys. It may have begun that way, but before long, something in their portrayal sparked the fans' imaginations. Indeed, the Klingons became more intriguing than any other alien race in *STAR TREK*, except for the Vulcans. Fans wanted to know who they were and how they came to be that way.

The TV series responded with excellent, detailed characterizations of some individual Klingons. Captain Koloth, played brilliantly by actor William Campbell, was almost charming in a sneaky way. Jovial and sarcastic, he obviously enjoyed his battle of wits with Kirk in "The Trouble with Tribbles". Commander Kor, on the other hand, led his Organian occupation force with ruthlessness and deadly precision in "Errand of Mercy". (The actor John Colicos went on to create another memorable portrayal as the treacherous Baltar in TV's *Battlestar Galactica*.) In "Day of the Dove", Kang was portrayed by the unforgettable Michael Ansara, no stranger to the villain's role. As the commander of a disabled Klingon ship whose crew is brought aboard the *Enterprise*, Kang showed that even a hard-boiled Klingon officer can learn to make peace—if he must. More recently, Mark Lenard was memorable as the first Imperial Klingon ever portrayed in film. In *STAR TREK III: The Search for Spock*, Christopher Lloyd treated fans to another fine portrayal of a Klingon. As Captain Kruge, Lloyd did for the Imperial Race what Colicos and Ansara did for Klingon/Human Fusions of the TV series.

However strong were the portrayals, the TV series revealed only a few tantalizing looks at Klingon culture and history. In "The Savage Curtain", for example, we meet Kahless the Unforgettable, the Klingon who created his race's traditions of treachery and tyranny, but we learn virtually nothing else of Klingon history. Klingon technology is revealed in bits and pieces in the series, but Klingon social customs remain a mystery. (By the way, "The Savage Curtain" portrays Kahless as a Klingon/Human Fusion because Kirk and Spock have not yet encountered many members of the Imperial race to this point in their careers. Because the recreated Kahless is based on their memories and thoughts, he looks as they might imagine a Klingon.)

To further confuse matters, *STAR TREK: The Motion Picture* and its sequels introduced us to an entirely different breed of Klingon—less Human in appearance and demeanor and with even greater savagery in battle. The first movie offered only a brief glimpse before the three *D-7M* battlecruisers were obliterated by *V'ger*, but with Captain Kruge of *STAR TREK III*, a whole new chapter in the Klingon saga opened up.

HOW TO USE THIS BOOK

This second, revised edition of *The Klingons* has been expanded to include much new background information and been revised to conform with the second edition rules of FASA's *STAR TREK: The Role Playing Game*. It has also been reformatted as a two-book set, so that players and gamemaster each have their own volume. The information in the *Game Operations Manual* is always correct, but the same material may sometimes be slanted, inaccurate, or somewhat misleading in the *Star Fleet Intelligence Manual*. The gamemaster must be thoroughly familiar with the contents of both books.

Where rules in this book contradict those in the basic set, the gamemaster may assume that the new rules are correct with respect to Klingons and their Empire. These exceptions are usually noted in the text.

Players and gamemaster who already own FASA-published adventures featuring Klingons will not find anything in this new edition that seriously contradicts those booklets. Indeed, the wealth of new detail in *The Klingons* should make playing those scenarios even more rewarding.

The information included in *The Klingons* is for gamemasters who wish to design or judge encounters, adventures, or campaigns prominently featuring Klingons. Players who will be roleplaying Klingon characters will also need access to this material. These rules and background information present the Klingons as seen up to and including the events depicted in the movie *STAR TREK IV: The Voyage Home*.

Gamemasters who want to run mainstream adventures or campaigns, i.e., campaigns centered on the activities of Star Fleet officers as player characters, will find this supplement useful for fleshing out the Klingons as a non-player race. Others may wish to use it to design adventures or campaigns in which the player characters themselves are Klingon officers, with the non-player foes being from the UFP or Romulan Star Empire. A number of such adventure modules are already available from FASA.



DESIGNING KLINGON ADVENTURES

MAINSTREAM DESIGNS

Star Fleet adventures or campaigns using Klingons as NPCs may occur any time after Reference Stardate 1/5105, date of official first contact between the Federation and the Klingon Empire, up to the present. When setting adventures during the pre-war period, the Four Years War, or the time of the *STAR TREK* TV series, however, the gamemaster must take care that events are consistent with the political and technological situation in the Klingon Empire at the time.

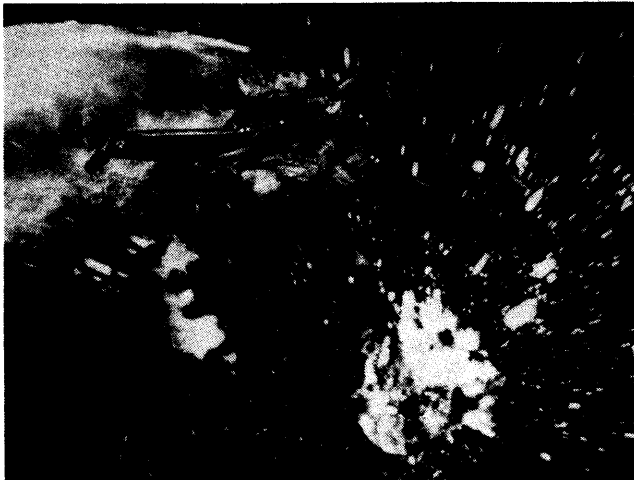

PRE-WAR ADVENTURES

In designing adventures set in the period prior to the Four Years War, the gamemaster must limit how much background knowledge of the Klingons that the player characters may use. Remember that the UFP knew very little about the Klingon Empire before the Four Years War. For example, Federation commanders had little or no knowledge of Klingon tactics and weaponry. Also, the existence of Klingon/Human Fusions was largely unknown to the UFP, and so all pre-war encounters would be with Imperial Race Klingons. Finally, both sides strictly observed the neutrality of the Orion Colonies.

Before the Four Years War, Federation vessels were equipped only with laser (not phaser) beam weaponry, and the only effective spaceborne projectile weapon was the accelerator cannon. Hand lasers were the standard sidearm of Star Fleet. Klingon vessels were equipped with low-power disruptors, and did not have torpedo-type weapons. The standard Klingon sidearm was a low-power hand disruptor, often of the sonic type. (For more detail on early ship-mounted weaponry, see the *STAR TREK Ship Construction Manual*, 2nd edition.) Though pre-war Klingon vessels were already equipped with transporter devices, Federation vessels were not until just before the war.

Scenarios set during this era would typically involve encounters between single ships of each side, or planetside meetings (often in Orion ports). Just prior to the war, the Federation made several attempts to open formal diplomatic relations with the Klingon Empire, and these might provide the basis for an adventure or two.

FOUR YEARS WAR ADVENTURES

The events of the Four Years War provide a fertile background for adventuring. During this time, the UFP made its first important discoveries about the nature of Klingon society, as well as meeting them in open and unrestrained battle for the first time. Gamemasters interested in this period should consult FASA's supplement **The Four Years War**, which provides in-depth coverage of that conflict.

The UFP encountered both Imperial Race and Klingon/Human Fusions during the war, with most encounters being of a military nature. Thus, scenarios set in this era would likely involve either naval engagements, ground assaults, or both. As a number of Star Fleet Intelligence operatives were assigned to the Triangle during the war, adventures involving undercover work within the Triangle and along the borders are also possible.

Phaser weaponry first came into use as shipboard and hand weapons during the latter part of the Four Years War, though the hand weapons did not become standard issue until several years later. Klingon weaponry of the time consisted of more powerful versions of the microwave disruptor. Some sonic disruptors were also still in use as hand weapons. Both sides used transporters during the Four Years War.

POST-WAR ADVENTURES

Post-war encounters with the Klingons would be similar to those portrayed in the *STAR TREK* TV series, and almost inevitably lead to conflict. These situations range from depiction of the Klingons as conquerors prior to the Pax Organia ("Errand of Mercy"), as troublemakers attempting to influence the development of inhabited worlds ("A Private Little War"), as galactic rivals in competition with the UFP for resources and allies ("Friday's Child"), and as tricksters attempting to sabotage UFP development efforts in the Organian Treaty Zone ("The Trouble with Tribbles"). These and other similar themes would make for interesting Klingon/UFP adventures.

Gamemasters must keep in mind that adventures taking place in the first ten years after the signing of the Organian Peace Treaty may not involve open warfare or any other armed hostilities (unless they occur along the Klingon Neutral Zone, which is not covered under the treaty). Rather, these adventures would involve more subtle conflicts challenging individual commanders and crews to use wit and wisdom rather than weapons to deal with problems. Most Klingons that UFP personnel encounter at this time are Klingon/Human Fusions. Imperial Race Klingons would generally be met only much deeper into the Central Empire.

The UFP used phasers during the post-war period, both as shipboard and as hand weapons. Photon torpedoes also came into widespread use as weapons systems on larger Star Fleet vessels at this time. Klingon warships used larger and more powerful disruptors, but did not yet have photon torpedo technology. The first high-energy hand disruptors also came into use in this era.

LATE HISTORY ADVENTURES

By the time of the *STAR TREK* movies, Imperial Race Klingons were exercising tighter control over border operations. Incidents along the Klingon Neutral Zone are now quite common, and UFP characters are much more likely to encounter Imperial Race Klingons manning Klingon ships and outposts in border areas.

Adventure situations set during this era would resemble those in the *STAR TREK* TV series, but with perhaps more military tension attached to the incidents. Secret Klingon spy missions deep into UFP territory (such as the one depicted in *STAR TREK III*) present other opportunities for conflict. Now that the Organians have apparently ceased policing the Treaty Zone, a major war could break out at any time.

The Klingons are as paranoid as ever, as their reaction to the Genesis Device showed only too well. The Klingons refer to it as the Genesis torpedo, and believe it represents new technology for arming Federation ships against their traditional foes in the Empire. The full range of UFP and Klingon Empire technology is available in this period, including photon torpedoes aboard both Star Fleet and Klingon vessels, cloaking devices used by the Klingons, and the first transwarp drive ships from Star Fleet (though these are still extremely large, expensive, and rare).

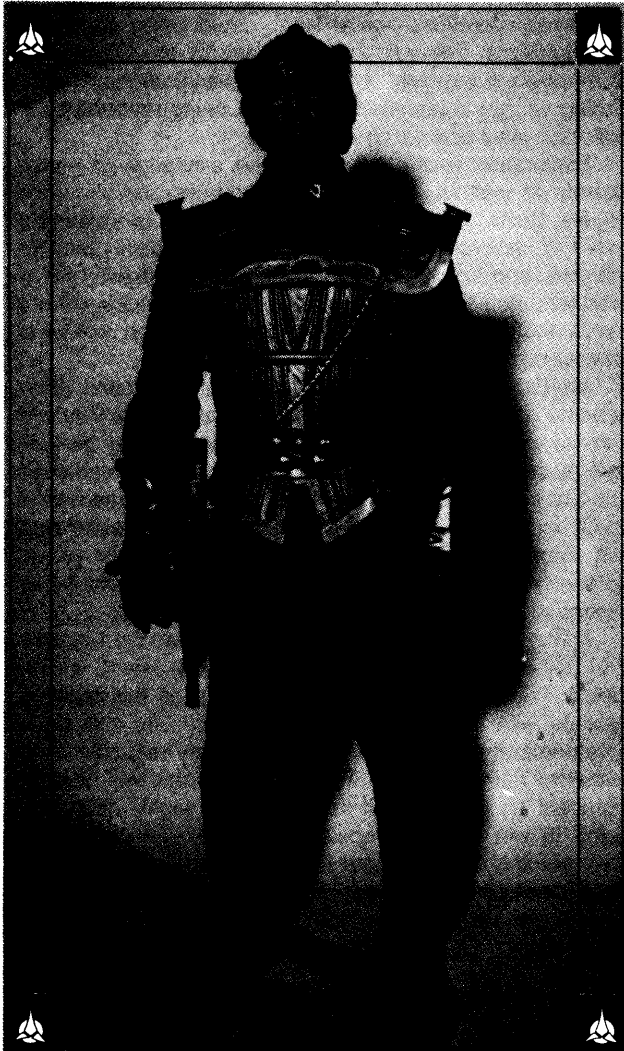

CIVILIAN CHARACTER ADVENTURES

Gamemasters will find FASA's **Trader Captains And Merchant Princes** supplement especially useful in designing adventures or campaigns based around merchants or other civilian characters. Setting such adventures near Klingon space (either in the Organian Treaty Zone, Orion space, or the Triangle) makes the possible developments even more exciting.

Merchant or civilian adventures in the Organian Treaty Zone would occur during the trade boom that resulted from the signing of the treaty, which permitted many independent traders to become involved in UFP/Klingon efforts to develop uninhabited planets in the zone. The treaty's prohibition against attacking by civilian vessels was a boon to merchants, because it freed them to use less-expensive, unarmed ships in these lucrative new markets.

Prohibitions against combat do not prevent *conflict*, however! Civilian Federation merchants are often the target of Klingon sabotage and treachery, because the UFP's development efforts in the Zone depend on reliable supply lines. (Being Captain of the regular grain freighter going to Sherman's Planet is a way to make big bucks, *if* you can keep the Klingons out of your hair and the tribbles out of the quadrottricale!) Don't forget the many story possibilities involving other non-Star Fleet specialists such as private security personnel, detectives, gamblers, corporate trouble-shooters, and so on.

When it comes to Orion space, there's always adventure to be found. The same smiling Orion contact man who gives stalwart UFP secret agents crucial information on the evil plans of the Klingon Empire is often the same one who then provides scheming Imperial spies with secret plans stolen from UFP files! Those contemplating adventures in the streets and alleys of Orion spaceports will want to consult FASA's supplement on **The Orions**, which describes in detail the galaxy's most devious merchants and their somewhat piratical society.

Of course, some of the *best* independent adventuring territory is in the Triangle, that slice of space caught between the borders of the three great powers represented by the United Federation of Planets, the Romulan Star Empire, and Klingon Empire. In this rough and rowdy frontier area, the small but feisty independent governments maintain their freedom from the influences of the Big Three. The few rules that do exist in the Triangle get broken with amazing regularity, and non-Star Fleet player characters can always find a quasi-legal way to turn an extra credit if they do not mind ducking a few disruptor bolts now and then.

Gamemasters contemplating adventures in the Triangle should consult FASA's supplement **The Triangle**, which includes complete maps and world logs for the region, plus background information on the various powerful groups competing for control there. The companion volume, **The Triangle Campaign**, contains a pre-generated campaign background that includes NPCs, adventure situations, plotlines, and everything else needed to set several lengthy campaigns in this wild and woolly region of space. Those who intend to spend a lot of time in the Triangle will probably also want to become familiar with FASA's **The Romulans** supplement, for the Star Empire is just as anxious for its cut of the pie in this part of the galaxy, too!

KLINGON-BASED ADVENTURES

The best adventures will likely be those where Klingon player characters must solve problems created by their own unique society. This tests the players' cleverness and ability to roleplay an alien lifestyle and background. Can players deal with a crisis and work together while still not quite trusting those around them, and while always keeping one eye open for the minions of Imperial Security? Sure they can, and that is what makes playing a Klingon fun.

Remember though, that player characters may be Klingons, but the *players* are not. Where the story demands specialized knowledge of Klingon life, the adventure must present that information, so that the players have some basis for trying to think like a Klingon.

PLANETSIDING ADVENTURES

Klingon starship crews, particularly those of the Imperial Klingon Expeditionary Forces and the Exploration/Colonization Fleet, face many of the same situations as Star Fleet crews. They are likely, however, to approach these situations in a very different and usually more direct manner. The clever gamemaster will draw on certain aspects of the interstellar political situation to prevent the Klingons from simply shooting their way out of every encounter, however.

Klingon player characters may be the officers of an exploratory vessel, just as with Star Fleet adventures. Many of the same guidelines apply to both Klingon and Star Fleet campaigns, but Klingon adventures should reflect different cultural goals and values. For example, exploratory vessels of the Empire will be looking for planets to exploit, not potential allies. What's more, Klingons will usually consider the intelligent races they may encounter to be either potential enemies or potential servitors.

Adventures that consist merely of raids of conquest usually turn out to be boring and futile, unless spiced with unusual situations. Much more interesting are adventures that pose problems that the characters must solve while working within the Klingon system. If the characters must stop a revolt, it is more challenging if the scenario requires that they balance force with careful diplomacy. Similarly, the problem of detecting a traitor will be more fun if the game requires the use of guile and trickery to uncover the spy rather than merely chasing him all over the ship in a running disruptor battle.

Life in the Klingon Empire, particularly for military officers, is often tense and dangerous, as much because of opposition from the UFP and the Romulans as because of one's own people! The wise Klingon never makes a move without checking his back and covering his tracks. In the Empire, one is *expected* to rise in power and prestige by grasping opportunities and by exploiting the momentary weaknesses of one's rivals. Thus, every Klingon player character should be alert to turn any situation to his advantage, certain all the while that his fellow Klingons are just as alert to any opportunity to take advantage of *his* mistakes. Surveying all this is the even more watchful eye of Imperial Security, recording what everyone does in order to protect the Empire. And don't forget Imperial Intelligence, the Emperor's *own* secret service.

This is not to say that Klingon player characters should constantly be at each other's throats, which would be a waste of time and manpower, and, therefore, inefficient. Wasting the Empire's resources is no way to get ahead, and so the game design should promote teamwork—up to a point. When preplanning an adventure, the astute gamemaster will also try to create opportunities for decisive personal action by individual players, too.

When Klingons are to be the player characters, the gamemasters must, of course, tailor adventures to their interests. Now it is the UFP characters who become 'the bad guys' trying to block the player characters at every turn. Cardboard villains do not make for good adventures, however. A worthy adversary is one who is intelligent, and an exciting plotline usually sets up a conflict between the goals and motivations of individuals or groups.

Hints for Planetside Adventures

When a Klingon starship commander discovers a promising new world, he will usually beam down an *Exploration Team* to the newly discovered planet. Such teams are always well-armed and heavily guarded by Marines, but also include scientific and command personnel. The job of an Exploration Team is to determine if the planet offers anything valuable to the Empire and to learn what obstacles might stand in the way of obtaining it.

Within the Treaty Zone, such teams must be careful to avoid treaty violations—or at least, avoid being caught in such violations. To avoid repercussions by the Organians, the Empire will severely discipline any violators they catch. (Getting caught is usually the result of being reported by a Federation team or other observers.)

Exploration teams will report the existence of native cultures, as well as of exploitable resources and planetary dangers. Such teams rarely have the authority to violate the treaty by taking military action on their own, but an ambitious and bold commander might try it anyway for a particularly rich find. If he is successful, the Empire will not quibble about methods. Failure, on the other hand, will bring punishment for endangering the Empire.

An *Exploitation Team* may be dispatched, either from the same or another ship, if a planet is found to be valuable in some way. Such teams may set up mining camps, observation posts, and so on. If it is done in violation of treaty, however, these teams know they are on their own if caught by UFP observers. Space is vast, however, and such violations may go undetected for months or years. Exploitation teams may suffer if the exploration teams failed to notice or to report dangerous conditions, however.

If the Klingons detect a native civilization on a new world (either from space or by an exploration team), a *First Contact Team* may be dispatched. It is up to this team to negotiate with the native civilization for treaties and trade agreements, if permissible under the Treaty regulations on contacting native cultures. First contact teams will attempt to present an alliance with the Empire as highly desirable, hoping to win over the locals before the UFP representatives get a chance to state their case at all. First contact teams must be led strongly by officers who are not too trigger-happy, or they may ruin their chances with a new native culture.



On uninhabited worlds with exploitable resources, a colonization effort may be mounted. Klingons often import servitor-race colonists to do the hard, dangerous work of proving a new colony. Many times, these 'colonists' are political prisoners or people unwillingly transported from other Klingon-dominated worlds. Such colonies are administered initially by a Klingon military governor and are guarded/protected by Klingon Marines assigned to that governor. Once a colony is established, the Klingons may set up leaders from the dominant servitor race as a civilian puppet government. This situation can change in an eyeblink, however. If the colony does not adhere to Empire policy or fails to meet Empire production quotas, the Klingons will immediately send in troops and a new military governor to rectify matters.

Outside the Organian Treaty Zone, there is no prohibition on conquering inhabited worlds by force. These raids of conquest are usually handled by the Imperial Klingon Expeditionary Forces backed by the Imperial Navy. Such assignments are highly prized (though dangerous), because the leaders are often rewarded by grants of lands or exploitation rights on conquered worlds. Military governors are usually appointed from among the victorious commanders as well.

After taking over a world, the Klingons will garrison it heavily, and military leaders take over administering the planet's affairs. If all goes well, they will later establish a military governorship, and finally, a civilian government (if the natives continue to be docile). The Empire will respond to rebel activity with increased military presence, however.

The security-conscious Klingons have pushed the borders of their exploratory efforts beyond their capability to exploit them. Thus, there exists a line of uncolonized frontier outposts at the fringes of explored space. Assignment to these posts is often a form of punishment for failure or serves to exile those whose ambitious nature worries their superiors. Troublemakers are often sent on dangerous assignments into unknown territory, in the hopes that they will die gloriously and thus advance the Empire without threatening their superiors. Sometimes, such assignments can backfire if the 'exile' beats the odds and returns with a rich prize for the Empire—if he can manage to keep his superiors from grabbing the credit for it. (Remember the well-known UFP joke: "How many Klingons does it take to install a light panel?" "Two. One to install the panel and one to shoot him and take the credit.")

KLINGONS VS. ROMULANS

Of course, the Klingons have other adversaries besides the UFP. There's plenty of excitement to be had along the Romulan/Klingon borders at any time from Reference Stardate 0/0001.30 (long before Terrans had left their home system) right through the events of *STAR TREK IV*. Indeed, the gamemaster can run entire campaigns where Humans never enter into the game at all, if players and gamemaster are knowledgeable and skillful. For a wealth of background information to help in creating Romulan adversaries for Klingon players, see the FASA supplement on **The Romulans**.

Campaigns set before 2/0902 can be filled with combat action, as the players deal with a continuing series of border disputes between the two Empires. These disputes cool down a bit after the first technological exchange treaties, but only on the surface. Even after the treaties, both sides conduct raids (mostly as 'privateers', without official sanction of their governments) on each other's merchant shipping and frontier outposts and settlements. A Romulan Captain on such missions would have to be crafty, experienced, and very lucky, indeed!

Adventures or campaigns can also be run with player characters on either side of the conflict. Experienced gamemasters with large player groups might occasionally find it interesting to have some players running Romulan characters and others running Klingons. This is guaranteed to be difficult to gamemaster, but richly rewarding in terms of fun and excitement. It is not recommended for gamemasters with weak hearts, fragile egos, or easily strained friendships among the players!

ORGANIAN TREATY ZONE ADVENTURES

One of the most important limiting factors on the conquering spirit of Klingon characters has been the Organian Peace Treaty, forced upon both the Empire and the UFP by the powerful energy beings of the planet Organia. According to the Treaty, signed in Stardate 2/0801, no UFP or Klingon starship may fire upon the other along that part of the Klingon/UFP border known as the Organian Treaty Zone. The Organians not only forbade hostilities, but also used their power to completely disable weapons in the Zone. Since Stardate 2/2107, however, the Organians have apparently ceased their active policing, and warships of both sides now may cross the Zone. No one

knows why the Organians have withdrawn their attention or if they may suddenly decide to intervene again. However, it has heated up the tensions that have always existed here.

During the period from 2/0801 to 2/2107, at least, the treaty required that the Klingons and the Federation keep hands off inhabited worlds in the Treaty Zone until such time as those planets were intellectually prepared to enter the interstellar community. (This was official UFP policy anyway, but the Organians used their power to strictly enforce it within the Treaty Zone.) When a civilization was deemed ready, both the UFP and the Empire could approach it with offers of membership, trade agreements, and so on. The planet's government or populace then had a choice of whether to form an alliance or remain independent.

In the case of a planet that had no native civilization (broadly defined to include sub-intelligent species capable of developing true sapience), the Organians awarded the world to the side capable of developing and using the world's resources most efficiently. The Klingons are very efficient, especially in mining and matter transmutation. The UFP, on the other hand, is more advanced in agriculture and energy resource development. Thus, the success rate was split almost evenly between the Empire and the UFP. The Organians reviewed each case periodically to see that resources were being used with continuing efficiency for non-combat purposes.

Either power could maintain bases and non-military installations in the Treaty area (such as the UFP's privately owned *K-7* space station). In practice, though, the Klingon Empire maintains only a very few refueling facilities there because the treaty dictates that crews of *either* side may claim emergency aid and/or shore leave rights at any such installations. Because most Klingon facilities are 'military' by definition, they are not too anxious to entertain foreign visitors there.

Thus, Klingon planetary adventurers must 'walk on eggs' within the Treaty Zone during the period of active Organian enforcement, in order not to risk a treaty violation that would result in disarmament by the Organians. The Empire will not tolerate any activity that endangers the treaty (out of pure fear of the Organian power), and will punish severely any Klingon who acts in a way that does so. However, one of the quickest ways to get ahead in the Empire is to win a moral victory over the UFP in the Organian Treaty Area. That means commanders must be especially devious, perhaps skirting the ragged edge of a treaty violation in pursuit of an advantage (as in the episode "The Trouble with Tribbles"). If successful, these commanders can look forward to vastly increased prestige and substantial material rewards.

KLINGON NEUTRAL ZONE

On the Triangle side of the Orion colonial star systems (whose neutrality is respected by the Empire for reasons of its own) lies a small section of the Klingon/UFP border still referred to as the "Klingon Neutral Zone". Most of the area originally under that name is now part of the Organian Treaty Zone. Like the Triangle, much of this area was at first considered mostly useless, as few habitable planetary systems lay within it. Because neither the Empire nor the UFP was anxious to develop it, conflict was rare. Indeed, this area was not included in the Organian Treaty negotiations for that reason.

After Stardate 2/1003, when rich deposits of dilithium and other minerals were discovered in the zone, Klingon warcraft eventually began to patrol it heavily, keeping just on their side of the Zone. Violators of their border were pursued and destroyed as a matter of course. As yet, the Organians have not expressed a desire to extend the Treaty Zone, but too many incidents in the Neutral Zone might bring this option to their attention.

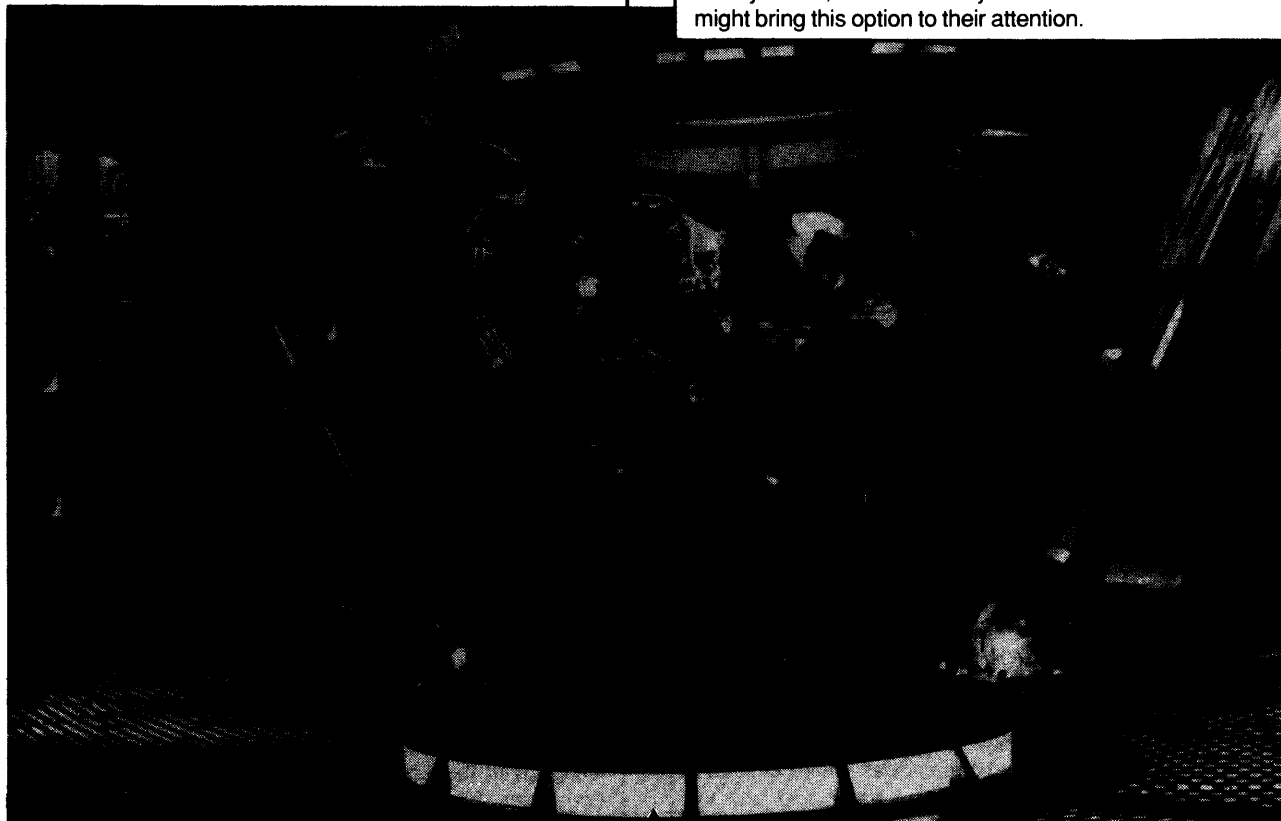

THE KLINGON EMPIRE

EXTENT OF THE EMPIRE

The map on p. 10 shows the explored and controlled extent of the Klingon Empire as of Reference Stardate 2/2401. The Empire's expansion originally remained centered near the Klingon homeworld of Klinzhai, but has recently pushed more to spinward as the Klingons feel out the limits of the UFP boundaries. Unlike the steady spherical growth of the UFP, Klingon expansion has been in fits and starts as first one, then another powerful line or consortium of lines seized and claimed valuable areas.

THE FOUR QUADRANTS

During their early expansion efforts, the Klingons divided the galactic reaches into four quadrants. They named each of these with one of the first four letters in the *Klingon-aase* alphabet, though UFP scholars refer to the quadrants as Alpha, Beta, Gamma, and Delta. All then-existing Klingon linefamilies were divided into four groups, and each group was awarded one quadrant to explore and exploit.

Klingon competitiveness doomed this idea very early, however. Lines fought both inside and outside the quadrant boundaries, making a mockery of the arrangement. Now, any line may have holdings in any quadrant, but the original quadrant boundaries survive as astrographic divisions of the Empire.

The linefamilies controlling Quadrant Alpha were quite successful in exploring and exploiting the region in the early days of the Empire. Indeed, their efforts led to an encounter between the Klingons and a Romulan scouting party at Delta Khinah II in Stardate 0/0001.30, the Empire's first confrontation with another interstellar expansionist civilization. The result was the First Klingon/Romulan War, which lasted three years. The war inflicted such heavy losses on both sides that the expansion efforts of both races were slowed dramatically. Klingon expansion has been stalled here ever since, with occasional clashes swaying the boundaries temporarily.

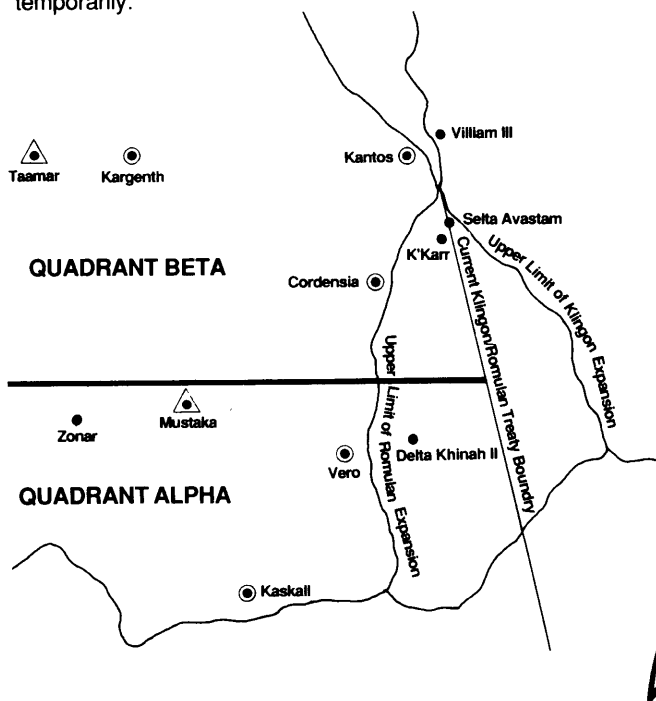

Quadrant Beta exploration came later, as ships pushed out along the Klingon/Romulan border looking for undisputed systems of value. Much of the border lies along an area known as the Triangle by the Klingons and as the Wedge by the Romulans. The Klingons and Romulans have disputed this area ever since the two groups met. However, neither side can muster enough strength to accomplish more than an occasional rebellion or skirmish. There are strong independent groups in the Triangle, including a renegade Klingon government claiming to be the Klingon Empire in exile. As Federation influence is also strong here, both Klingons and Romulans are cautious about how hard they push their expansionistic efforts.

Pushing further along this border brought the Klingons to encounter the Orions and then the Federation. The Orions have proved valuable to the Klingons as trading partners, allowing them access to many UFP items and secrets that otherwise would be difficult or impossible to come by. The UFP itself has proven to be a thorn in the Klingon Empire's side, however, and something of a puzzle, too. The Klingons are mystified by the Federation's non-aggressive expansionist policies, because they believe in the policy of taking what they want. Though they have tested the might of the UFP again and again, the Klingons have never been able to make much permanent headway into UFP space. A Neutral Zone now exists along the UFP/Klingon border from Orion space to the Triangle.

Quadrant Delta has expanded more than any of the other three quadrants. Though the Organians have stabilized this portion of the UFP/Klingon border as the Organian Treaty Zone, Klingon expansion efforts have been quite successful in areas away from the UFP border.

Quadrant Gamma borders neither the Federation nor the Romulans, but expansion here has been more limited than in any other quadrant. In Stardate 1/8203, the Klingons encountered the Kinshaya, who became the most serious threat to expansion that the Empire has ever faced. Indeed, the threat is so severe that the Klingons have slowed their coreward expansion to a snail's pace. Instead, they have been building enormous defensive bases here and expanding their military might so as not to be caught with their back door open. The Klingons are moving cautiously in this area, taking one planet at a time and entrenching themselves firmly on it before going on to the next.

The Empire is now in a period of consolidation, putting all efforts into building the mightiest military force the galaxy has ever known. They are always testing their opponents, gathering new intelligence about tactics and weaponry. Sooner or later, they expect to find a gap where one or more of their rivals is weak. And when that gap is found, the Klingons will not hesitate to strike.

Defense Complexes

The Empire has constructed ten major defense complexes to act as supply bases, manufacturing centers, and major headquarters stations. The base at H'Renn is the oldest and largest of these. By Imperial decree, there is none at Klinzhai (other than the planetary defense complex at Darbva, which was not designed to be an interstellar war center). This precedent was established early in the Empire's history. Because of the continual warring over the seat of the Empire, it became obvious that the constant skirmishes were a threat to badly needed production centers. Though Klinzhai has not seen war in many years, the Empire maintains this rule to preserve the homeworld's security.

Defense complexes are interior defenses, and not intended as frontier installations. Each is charged with coordinating military efforts in its region, and with supplying those efforts if the Empire is invaded. The Klingons have built and scattered these installations more because of their own inner squabbles than as a defense strategy against the Romulans, UFP, or others. With ten defense complexes now in existence, the Empire still has enough to fall back on if a splinter group should seize one of them. Security near these is tighter than at any other place in the Empire. No ship can approach insystem without being detected and challenged. Non-military vessels may not even enter the system except at the fringes where waystations have been constructed to conduct necessary business.

Each defense complex is a major industrial world or system run entirely by the naval force in control of that particular area of space. Arms are stockpiled here, and many ships are built in orbital facilities. The resident populations are military in nature, with dependents allowed at some facilities. Most worlds have upwards of a million inhabitants.

Three new facilities are in the planning and construction phase. Two of these are on the 'western' fringes of expansion, while the third is more centrally located.

Border Outposts ●

Border outposts are located at various points along the Klingon frontier. These stations serve as manned listening posts to warn the Empire of an invasion. They also serve as supply depots for vessels patrolling the nearby area, or as waystations for vessels preparing to slip across a border. The Klingons are constantly constructing more of these along both the Romulan and UFP borders.

Star Fortresses ●

These are major bases located near the Empire's borders. They provide full orbital ship construction and repair, rest and recreation facilities, communications relay equipment, and regional headquarters for military forces in the area. Star fortresses have been placed even in systems where there are no planets suitable for colonization. The bases are always supplemented by orbital facilities and are defended by in-system defense boats.

Star fortresses have resident populations of 50,000 to 150,000 personnel, including dependents. Despite their size, they are not normally intended as permanent facilities, although a few have developed into such. There are a few permanent bases along the Romulan and Kinshaya borders. Normally, as borders change and the Empire grows, the star fortresses are stripped and abandoned, with defense of the area being relegated to a more conventional base or patrol by ship. Occasionally, a star fortress is converted into a defense complex, training center, or repair station.

Frontier Outposts ○

Frontier outposts are similar to border outposts, but are normally located along non-Romulan or non-UFP areas. Built on small asteroids or planetside, these facilities are 'bare-bones' operations. They are built to serve as waystations, small repair facilities, and early warning and reaction posts. They do not have assigned system-defense ships, but there is usually at least one armed vessel to be found at a facility, where it is undergoing repairs or delivering much-needed supplies. Frontier outposts also serve as bases for exploration vessels preparing to venture across established borders.

Resident populations are usually less than 5,000, with no dependents allowed. Due to border changes, these facilities are often mothballed as the Empire expands. When no longer viable as frontier outposts, the facilities are occasionally converted for storage and other uses.

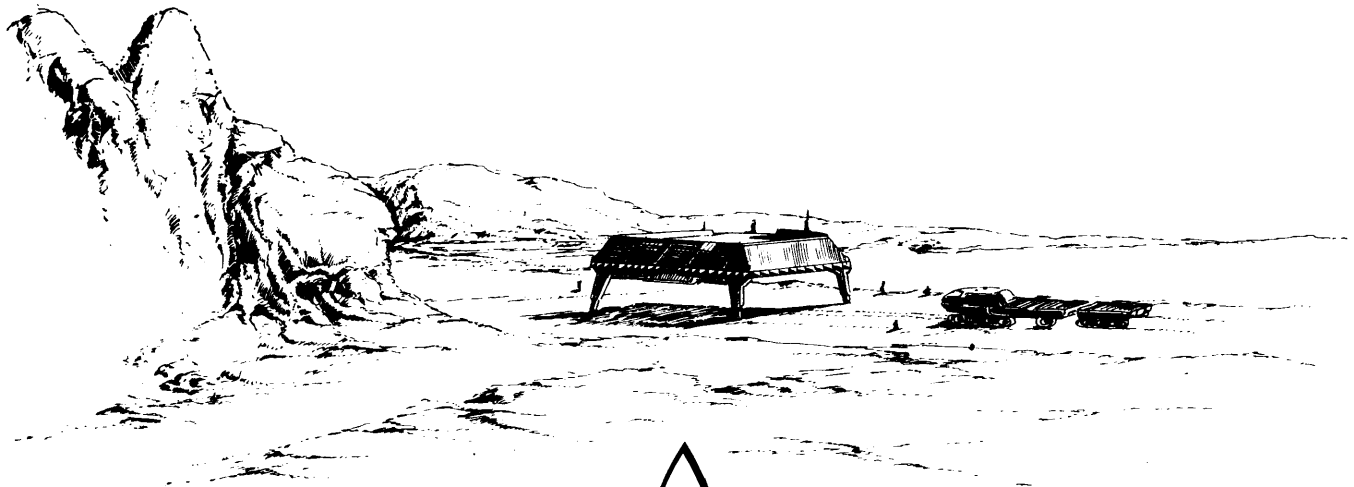

NOTEWORTHY PLANETS

World Log: DELTA KHINAH II

System Data

System Name: Delta Khinah
Map Coordinates: 16.00S 7.23 E
Number Of Class M Present: 1

Planetary Data

Position In System: 2
Number Of Satellites: 2
Planetary Gravity: .8g
Planetary Size
Diameter: 10,400 km
Equatorial Circumference: 32,000 km
Total Surface Area: 408,000,000 sq km
Percent Land Mass: 34%
Total Land Area: 139,000,000 sq km

Planetary Conditions

Length Of Day: 32 hours
Atmospheric Density: Terrestrial
General Climate: Warm temperate

Mineral Content

Normal Metals: 1%
Radioactives: Trace
Gemstones: 22%
Industrial Crystals: Trace
Special Minerals: 8%

Cultural Data

Dominant Life Form: Khinahni
Technological/
Sociopolitical Index: 999794-75
Planetary Trade Profile: CFFDDDE/C(C)

Noteworthy Facts: The *Klingonaase* name of this planet means "bravado". The natives of Delta Khinah II were the first to become a servitor race of the Klingon Empire. The planet was also the site of the Empire's first encounter with the Romulan Star Empire.



World Log: SELTA AVASTAM

System Data

System Name: Selta Avastam
Map Coordinates: 13.14S 7.79E
Number Of Class M Present: 1

Planetary Data

Position In System: 10
Number Of Satellites: 2
Planetary Gravity: .6g
Planetary Size
Diameter: 7,800 km
Equatorial Circumference: 24,000 km
Total Surface Area: 306,000,000 sq km
Percent Land Mass: 57%
Total Land Area: 174,000,000 sq km

Planetary Conditions

Length Of Day: 24 hours
Atmospheric Density: Terrestrial
General Climate: Warm temperate

Mineral Content

Normal Metals: 62%
Radioactives: Trace
Gemstones: 9%
Industrial Crystals: Trace
Special Minerals: 9%

Cultural Data

Dominant Life Form: Klingon
Technological/
Sociopolitical Index: 999794-75
Planetary Trade Profile: BBEDCDE/B(C)

Noteworthy Facts: This metals-rich world was traded to the Klingons in one of the Klingon/Romulan technology exchange treaties. Lying just beyond the Klingon side of the border, it marks the furthest penetration of a Klingon colony into Romulan space.



World Log: VILLIAM III

System Data

System Name: Villiam
Map Coordinates: 11.92S 7.65E
Number Of Class M Present: 1

Planetary Data

Position In System: 3
Number Of Satellites: 1
Planetary Gravity: 1.3g
Planetary Size
Diameter: 16,900 km
Equatorial Circumference: 52,000 km
Total Surface Area: 663,000,000 sq km
Percent Land Mass: 9%
Total Land Area: 60,000,000 sq km

Planetary Conditions

Length Of Day: 24 hours
Atmospheric Density: Terrestrial
General Climate: Cool Temperate

Mineral Content

Normal Metals: 1%
Radioactives: Trace
Gemstones: 24%
Industrial Crystals: Trace
Special Minerals: 3%

Cultural Data

Dominant Life Form: Romulan
Technological/
Sociopolitical Index: 999995-87
Planetary Trade Profile: GGGFGGG/C(E)

Noteworthy Facts: Unsuitable for mining and with an atmosphere too thin for agriculture, this planet is notable only for its place in Klingon/Romulan history. Located outside the sphere of Klingon influence, this world was the site of the first Klingon/Romulan conferences on technology exchange agreements, and the first treaties were signed here.



World Log: KANNAGA

System Data

System Name: Sinnawa Lotos
Map Coordinates: 9.41S 4.58E
Number Of Class M Present: 1

Planetary Data

Position In System: 6
Number Of Satellites: 0
Planetary Gravity: 1.5G
Planetary Size
Diameter: 19,500 km
Equatorial Circumference: 60,000 km
Total Surface Area: 765,000,000 sq km
Percent Land Mass: 51%
Total Land Area: 390,150,000 sq km

Planetary Conditions

Length Of Day: 31 hours
Atmospheric Density: Thin
General Climate: Tropical

Mineral Content

Normal Metals: 12%
Radioactives: Trace
Gemstones: Trace
Industrial Crystals: Trace
Special Minerals: Trace

Cultural Data

Dominant Life Form: Klingon
Technological/
Sociopolitical Index: 999794-75
Planetary Trade Profile: DEFEDFF/C(D)

Noteworthy Facts: Kannaga (named by the Klingons) is a metals-poor world that is, however, of immense value to the Empire for its proximity to Federation space. It is the closest major base the Klingons have to the UFP, and they have sent a great many colonists to Kannaga. Over the years, these settlers established cities that have grown quite large.

The Klingons maintain heavy patrols in the area and will intercept any vessel entering the system. If they grease the right palms, however, legitimate traders may be given the right to land and carry out trade. Seven Battle Groups are based directly at Kannaga, with many more passing through on a regular basis. Large numbers of ground troops are usually based here, with a major chunk of the planet given over to training areas.



World Log: K'KAARR

System Data

System Name: Lothos
Map Coordinates: 13.32S 7.61E
Number Of Class M Present: 1

Planetary Data

Position In System: 10
Number Of Satellites: 0
Planetary Gravity: 1.2g
Planetary Size
Diameter: 15,600 km
Equatorial Circumference: 48,000 km
Total Surface Area: 612,000,000 sq km
Percent Land Mass: 4%
Total Land Area: 24,480,000 sq km

Planetary Conditions

Length Of Day: 32 hours
Atmospheric Density: Thick
General Climate: Warm Temperate

Mineral Content

Normal Metals: 37%
Radioactives: 25%
Gemstones: Trace
Industrial Crystals: Trace
Special Minerals: Trace

Cultural Data

Dominant Life Form: Klingon
Technological/
Sociopolitical Index: 999794-75
Planetary Trade Profile: EBDEDF/C(X)

Noteworthy Facts: K'Kaarr is the Klingon base nearest to the Romulans, making it the scene of much intense fighting over the years. The Klingons maintain a primarily military presence here with few civilians. The small equatorial land masses have been transformed into barracks for Klingon ground troops. At any given time, there are at least ten Battle Groups in the system, with more passing nearby at all times.



World Log: PHILLO'TOK V

System Data

System Name: Phillo'tok
Map Coordinates: 9.89S 3.17E
Number Of Class M Present: 1

Planetary Data

Position In System: 5
Number Of Satellites: 2
Planetary Gravity: .9g
Planetary Size
Diameter: 11,700 km
Equatorial Circumference: 36,000 km
Total Surface Area: 459,000,000 sq km
Percent Land Mass: 96%
Total Land Area: 440,640,000 sq km

Planetary Conditions

Length Of Day: 29 hours
Atmospheric Density: Terrestrial
General Climate: Warm Temperate

Mineral Content

Normal Metals: 20%
Radioactives: 13%
Gemstones: Trace
Industrial Crystals: Trace
Special Minerals: Trace

Cultural Data

Dominant Life Form: Orion
Technological/
Sociopolitical Index: 999994-77
Planetary Trade Profile: BBCCCD/B(C)

Noteworthy Facts: This system was the site of the first Klingon/Orion meeting in 0/7202. The planet was later taken over by the Klingons with the Orions' blessings and was established as a trade center between the two. For a few years, the center flourished, but in later years was used only rarely. Over time, the Klingons nearly withdrew from this area.



World Log: T'DAKKA V

System Data

System Name: T'Dakka
Map Coordinates: 17.26S 3.87W
Number Of Class M Present: 1

Planetary Data

Position In System: 5
Number Of Satellites: 0
Planetary Gravity: 1.0g
Planetary Size
Diameter: 13,000 km
Equatorial Circumference: 40,000 km
Total Surface Area: 510,000,000 sq km
Percent Land Mass: 62%
Total Land Area: 316,200,000 sq km

Planetary Conditions

Length Of Day: 25 hours
Atmospheric Density: Terrestrial
General Climate: Arctic

Mineral Content

Normal Metals: 21%
Radioactives: 11%
Gemstones: Trace
Industrial Crystals: 8%
Special Minerals: Trace

Cultural Data

Dominant Life Form: Klingon
Technological/
Sociopolitical Index: 999794-75
Planetary Trade Profile: GBBDCCE/B(C)

Noteworthy Facts: T'Dakka, or "Place of Death", is the site of the first meeting between the Klingons and the Kinshaya. The system was discovered in 1/8203. Several scouting groups were lost here before a lone surviving vessel escaped with only a few crewmen alive. The Klingons had finally met their match in the Kinshaya, and this strong enemy brought the Empire's expansion efforts in this area to a halt. The Empire is now building major star fortresses and bolstering its forces in this area to prevent further loss to the demon race.



World Log: AXANAR

System Data

System Name: Delta Orcus
Map Coordinates: 2.46S 0.47W
Number Of Class M Present: 1

Planetary Data

Position In System: 1
Number Of Satellites: 0
Planetary Gravity: 1.12g
Planetary Size
Diameter: 14,330 km
Equatorial Circumference: 50,420 km
Total Surface Area: 645,124,000 sq km
Percent Land Mass: 11%
Total Land Area: 70,963,000 sq km

Planetary Conditions

Length Of Day: 27 hours
Atmospheric Density: Terrestrial
General Climate: Arctic

Mineral Content

Normal Metals: 10%
Radioactives: 9%
Gemstones: Trace
Industrial Crystals: Trace
Special Minerals: 12%

Cultural Data

Dominant Life Form: Axanarian
Technological/
Sociopolitical Index: 677663-46
Planetary Trade Profile: DDBFEEE/D(D)

Noteworthy Facts: Delta Orcus was the site of the signing of the Treaty of Axanar on Stardate 1/9806.13, which ended the Four Years War between the Federation and the Klingons. The system lies within UFP borders. (See FASA's **Return to Axanar** and **The Four Years War** for further information.)



World Log: MASTOCAL

System Data

System Name: Sigma Kinna
Map Coordinates: 8.87S 3.00E
Number Of Class M Present: 1

Planetary Data

Position In System: 9
Number Of Satellites: 2
Planetary Gravity: 1.2g
Planetary Size
Diameter: 15,600 km
Equatorial Circumference: 48,000 km
Total Surface Area: 612,000,000 sq km
Percent Land Mass: 31%
Total Land Area: 189,720,000 sq km

Planetary Conditions

Length Of Day: 21 hours
Atmospheric Density: Thick
General Climate: Warm Temperate

Mineral Content

Normal Metals: 33%
Radioactives: 10%
Gemstones: Trace
Industrial Crystals: 6%
Special Minerals: Trace

Cultural Data

Dominant Life Form: Klingon
Technological/
Sociopolitical Index: 999794-75
Planetary Trade Profile: ECEDDDE/B(B)

Noteworthy Facts: At the time of its completion in 2/0109, Mastocal was the largest Klingon naval base yet built. From here, the Klingons intended to extend their influence into Federation space, using Mastocal as their base of operations. The Organians interfered with their plans, putting a halt to the intended war. The Empire is still building up Mastocal, however, sure that one day they will find a way around the Organians into the Federation.

Mastocal is essentially one large planet-wide base. There are training facilities, planetside and orbital repair facilities, R & R facilities, and manufacturing plants for smaller weapons and tools of war. No shipbuilding facilities are maintained here, although extensive repairs can be made to any size vessel in the Klingon navy.

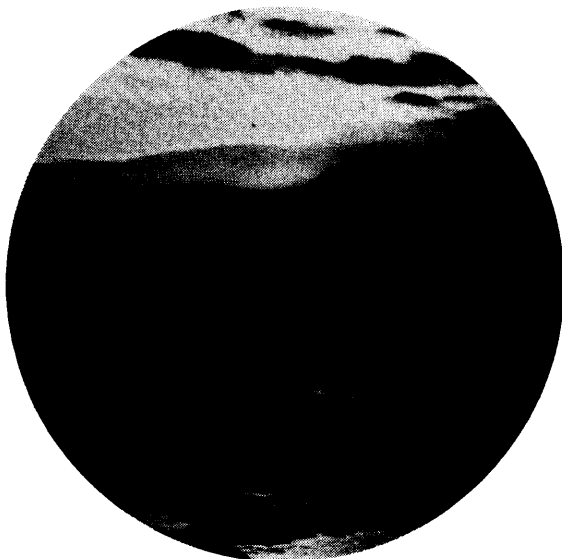

World Log: KOSTNER

System Data

System Name: Delta Cyanna
Map Coordinates: 8.48 S 9.19W
Number Of Class M Present: 1

Planetary Data

Position In System: 10
Number Of Satellites: 2
Planetary Gravity: 1.4g
Planetary Size
Diameter: 18,200 km
Equatorial Circumference: 56,000 km
Total Surface Area: 714,000,000 sq km
Percent Land Mass: 3%
Total Land Area: 21,420,000 sq km

Planetary Conditions

Length Of Day: 28 hours
Atmospheric Density: Thick
General Climate: Tropical

Mineral Content

Normal Metals: 45%
Radioactives: 29%
Gemstones: Trace
Industrial Crystals: 11%
Special Minerals: Trace

Cultural Data

Dominant Life Form: Klingon
Technological/
Sociopolitical Index: 999794-75
Planetary Trade Profile: GABCCDE/B(B)

Noteworthy Facts: Kostner is the base for Klingon expansionism 'westward' past the UFP borders. Although agriculturally poor, the planet more than makes up for it in production of raw minerals and crystals. The Klingon Navy has established a rather large base here, including orbital ship repair facilities. The Klingons are currently transforming Kostner into a defense complex, but completion of primary shipyards is not expected for ten more years. Ground force barracks and training centers, however, will be completed shortly.



World Log: KASKALL

System Data

System Name: K'Korran
Map Coordinates: 18.13S 4.97E
Number Of Class M Present: 1

Planetary Data

Position In System: 8
Number Of Satellites: 3
Planetary Gravity: 1.3g
Planetary Size
Diameter: 16,900 km
Equatorial Circumference: 52,000 km
Total Surface Area: 663,000,000 sq km
Percent Land Mass: 6%
Total Land Area: 39,780,000 sq km

Planetary Conditions

Length Of Day: 25 hours
Atmospheric Density: Terrestrial
General Climate: Tropical

Mineral Content

Normal Metals: 39%
Radioactives: Trace
Gemstones: Trace
Industrial Crystals: 16%
Special Minerals: 12%

Cultural Data

Dominant Life Form: Klingon
Technological/
Sociopolitical Index: 999794-75
Planetary Trade Profile: GBCDDEE/C(C)

Noteworthy Facts: Kaskall is the largest coreward base established to date by the Klingons. The planet is being heavily mined for its vast mineral wealth. Otherwise, the only activity is the construction of a large, planetside military base and orbital naval facilities.



KLINGON HISTORY

This information is presented for gamemasters only. It is accurate and complete. Players who will be roleplaying Federation characters should *not* have access to this material.

EARLY HISTORY

Unlike Romulans, Humans, Vulcans, and others, the Klingon race was not created by an ancient and vanished race known as the Preservers. According to Federation theories, this ancient race seeded pre-human beings on many planets throughout this part of the Milky Way galaxy. Using genetic tailoring, the Preservers altered the physiology of each seed race to suit the conditions of the planet that would become its home. Though Humanity undeniably developed on Earth, the Vulcans and Romulans (who are an offshoot of the Vulcan race) may have come from the same ancestry as modern Humans, with their copper-based blood chemistry a result of radical genetic alteration.

The Romulans consider their connection to the Preservers (who they know as the Great Brothers) to be an established fact. To the Vulcans and Humans, it is an interesting and compelling theory, backed up by much evidence gathered on many worlds. Though Klingon archeologists have discovered Preserver race ruins on their home planet, Klingons do not believe in the non-Klinzhai origins of their race. In this, they are correct. (Klingons have been known, however, to claim otherwise to gain access to Preserver technology in the hands of Humans and others.)

The Klingon race evolved from primate-like bipeds native to Klinzhai's jungles, without help from the Preservers. It is likely that the Preservers knew of the existence of the sub-intelligent species that evolved as the Klingons, however. Indeed, the Preservers may have copied some of what they saw developing on Klinzhai, which might explain the resemblance of Humans and other Humanoid bipeds to Klingons. In *STAR TREK's* time, no one is sure, or will ever be sure.

Early Klingon civilization consisted of small tribes ruled by leaders who based their authority on strength and fighting ability. As organization became necessary for more efficient group defense, these tribes coalesced into larger units that were expansionistic and battle-hardened. The jungles of Klinzhai weeded out the weak, producing a society of warrior/hunters. The need for ever larger hunting grounds to feed ever larger tribes made war a way of life.

With land at a premium, the people of Klinzhai made full use of the seas much earlier than did Terrans. Mighty navies eventually linked Klinzhai's many small island groups, creating a number of societies dependent on the sea for their existence. The split between the two major cultures that developed reached a peak with the consolidation of the so-called *komerex Nevre* ("Northern Empire") and the *falgav a'kavna* ("Crescent Islanders"). The *komerex Nevre* was a sea-going culture based in the northern islands of Klinzhai. The *falgav a'kavna* were culturally similar, but had developed in the island grouping in the hollow of the planet's largest land mass.

After fighting a number of major wars, the Northern Empire swallowed up the Crescent Islanders, and went on to offer the first serious challenge to the major shore-based empire, known only as *komerex Klingon* ("Empire of The People"). The war between these two empires raged on and off for hundreds of years. Names and political divisions changed, but the conflict remained constant.

Eventually, the former Northern Empire (now calling itself simply *komerex dexiKlingon*, "Empire of the True People", developed nuclear weapons. The advance from firearms to nuclear devices came in a much shorter period than on Earth, due to the accidental discovery of a process to extract uranium and other rare radioactives from Klinzhai's soupy sea water.

Paradoxically, it was the impatience to use nuclear weapons that was the undoing of the True People's sea-going empire. They used their one and only nuclear device to destroy Khal City, the enemy capital. Instead of crushing the land-dwellers, the attack actually unified the many factions in the city. The True People had no time to manufacture more nuclear weapons before their opponents launched a massive assault against them. Half of the True People's military leaders took advantage of the chaos, switched sides, and ended up in charge of much of the victorious land dwellers' occupation army. Ironically, it is the conquered True People's language that survived, eventually to become modern *Klingonaase*. The conquerors simply found it easier to learn the new language than to seek out all the little island clusters to teach the natives the language of the land-dwellers.

A shaky coalition of military leaders now held the reins of government. As yet, there was only a military council and no single Emperor, but the name *komerex Klingon*, or Klingon Empire, first came into use officially at this time. The turncoat military took over nuclear technology, using it to develop the first efforts at space travel. This placed space exploration firmly in the hands of what was to become the Klingon Navy. The ground-based forces of the original land-dwellers became today's Klingon Imperial Marines. The Imperial Marines enforced a total ban on the use of nuclear fission as a weapon on the ground, and so Klinzhai never suffered any further use of nuclear weapons on its surface. Instead, nuclear energy carried them into space to fight other battles.

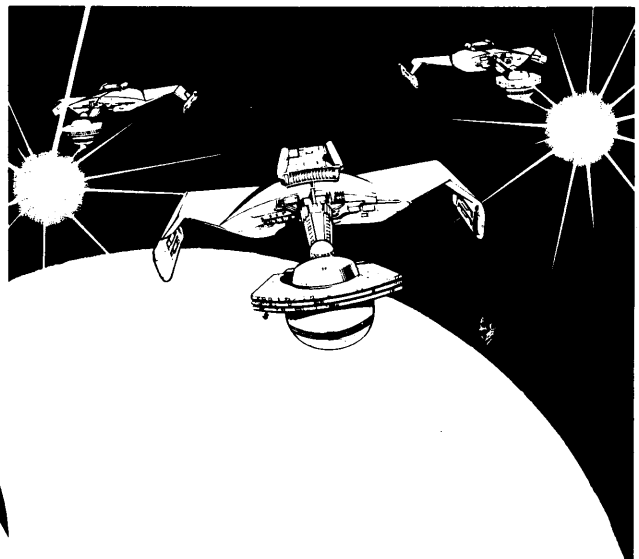

KOBЕК CONQUEST

The Klingon Empire lost no time in taming the only other habitable world of their system, a planet called Kobek after an ancient hero of the sea-dwellers. The Kobek colonies gained in power and wealth, until the influence of their governor rivalled that of the Klingon Emperor himself. Obviously, this state of affairs could not continue forever.

Kobek's governor (whose name has not survived numerous official 'revisions' of Klingon history) illegally created a huge stockpile of nuclear weapons and biological agents. This required him to bribe Marine officials on a massive scale, which seriously weakened the economic base of his holdings. Inevitably, someone did not stay bribed, and so the Klingon Emperor Kag'dan learned of the danger. In typical Klingon fashion, he acted decisively (and without a lot of forethought), sending in the Navy to destroy the stockpile in its secret location. The result was a detonation of incredible force that released deadly biological agents. At least 80 percent of Kobek's population was dead within two Terran weeks.

To make matters worse, the explosion changed the planet's axial tilt and orbit, making it eccentric and wobbly. Klingon astronomers soon determined that Kobek was doomed. Within 40 Terran years, tidal stresses from the new eccentric orbit tore the planet apart. Though losing an entire colonized world was an enormous setback to Klingon expansion efforts, scientific observations of the explosion led eventually to the discovery of controlled antimatter reaction and the development of warp drive.



UNIFICATION

Ironically, it was the development of warp drive that cemented the Imperial form of government and created the Klingon Empire in its present form. After the destruction of Kobek, the coalition of military leaders nearly tore itself apart from within. There were many minor reasons for the squabbles, but the underlying cause was the lack of any better targets of conquest. There were no new frontiers for the Klingons. No other world in their system was even marginally fit for colonization. The coalition leaders began looking at each other's personal lands as possible prizes to be won.

Only one leader looked out, not in. A rugged and ruthless young warrior, he nevertheless had settled for a position in the military government as controller of the Military Sciences operations for the fledgling Empire. Though his peers and elders thought him unambitious and foolish, this Klingon would prove to be the craftiest and most ruthless of all.

His 'harmless' position actually accomplished two things: it kept him from being a target, and it gave him control over some of the finest minds in the Klingon Empire. He used those minds and his access to secret data gathered during the destruction of Kobek to solve the riddle of matter/antimatter power generation.

Next, he secretly diverted funds from research projects to the construction of a small orbital station, using a matter/antimatter pod for power. Once the station was safely in orbit, bearing most of the scientists responsible for the project, the ruthless leader had every other person who knew of the station killed, which included more than 2,300 Klingons.

Now in a position to deliver his single demand to his fellow members of the ruling council, he insisted that they name him as sole Emperor or suffer the horrible consequences of a huge matter/antimatter explosion in close orbit. Though the council members were willing to risk it, their subordinates were not. They ended up putting their own leaders to the sword and swearing fealty to the new Emperor.

There followed one of the bloodiest purges in Klingon history, during which the new Emperor executed anyone he considered untrustworthy. Some believed the Emperor would soon fall to ambitious young Klingons suffering from the boredom accompanying a lack of worlds to conquer. The new matter/antimatter power source opened the way for the development of warp drive, however, and so ambitious young Klingons soon turned their eyes to space instead.

In his lifetime, this first Klingon Emperor saw his people united under one banner, and then saw that banner carried to the stars. He accomplished his goals through utter ruthlessness and bold action. For this, the Klingon people vowed he would always be remembered, as indeed he is. His original linename is unknown. On the day he became Emperor, however, he founded a new name. He was, of course, Kahless epetai-Riskadh.

EARLY EXPANSION

Under the leadership of Kahless, the Klingon Empire leaped outward from its home system to colonize all the habitable systems within reach. The Klingons' first warp drive vessels were fairly slow, capable of no more than Warp 3. Though many such vessels never returned from space, there were always more ambitious young Klingons wanting to seek fortune and fame as part of the expansion effort.

Kahless' sons and other adoptees of the new Riskadh line commanded many of these missions. It was the way Kahless could reward their loyalty while keeping them safely out of the way of his political ambitions at home. This practice was eventually to prove fatal to the line, however. Kahless was first and foremost a warrior, not a politician. He longed for battle, which came sooner than he expected.

In its first decade of expansion, the young Empire met with only token resistance. The first Klingon contact with another sentient species occurred when Empire scoutships landed on Delta Khinah II. The pre-tribal aborigines of that world thought the Klingons were gods, and so the Klingons lost no time taking advantage of the fact. The Khinahni became the first *kuve*, later serving as heavy laborers on a number of Klingon colony worlds.

The Klingons were not the first space travellers to encounter the Khinahni, however. Years before, a small Romulan scout had discovered the system, recording from orbit the presence of a pre-tribal culture on the planet. At the time, the Romulan Star Empire did not have the ships or the men to secure a settlement on Delta Khinah II, and so they made no attempt to conquer it. On Reference Stardate 0/0001.30, the Romulan scoutship *L'Sattak* returned for a second survey. It was immediately attacked and destroyed by two much larger Klingon vessels, but not before transmitting a distress message that included log tapes of the incident.

The colonization convoy travelling about 20 solar days behind the Romulan scout picked up the message. By the time they came out of warp near Delta Khinah, the Romulans were battle-ready. The small Klingon fleet had not yet received requested reinforcements, and so the Romulans wiped them out in a fierce attack. The Romulans were unprepared for a ground assault, however, and so had to remain in orbit to await ground troop transports.

When word reached Kahless of the discovery of another space-travelling race—one that had bested his occupation fleet—he turned the reins of government over to his eldest son and personally led the relief fleet into battle. So began the first Romulan/Klingon War.

THE ROMULAN ENEMY

Kahless' forces and the Romulan fleet battled one another in 17 star systems over the next three years. Klingon military hardware was superior to Romulan equipment, but the Romulans' ferocity in battle made up for it. In war, Kahless was in his element at last. A brilliant battle commander, he came to respect the Romulans' devotion to their cause, while hating them for standing in the way of his conquest. When his eldest son (who had been maintaining the Klinzhai government in Kahless' absence) died accidentally, Kahless was summoned home. His craving for battle was so strong, however, that he dispatched a message naming his son's top assistant, Kagran epetai-D'kariv, as temporary regent—and kept on fighting instead of returning home.

Kahless had decided to run the Romulans out of the sector once and for all. After identifying the major Romulan outposts there, he launched a crushing two-pronged attack against them. Though the Klingons lost most of their vessels in the battle, they managed to wipe out completely the two critical Romulan outposts. It was in this battle that Kahless, swearing to return with his ship or not at all, led the final assault with his left hand tied to the arm of his command chair. He made good on his promise, too, dying on the bridge of his flagship when it was breached by Romulan fire. As none of his sons survived the battle, either, Kahless's line died with him. (It is rumored that one son was forced to commit suicide to remove the last Riskadh heir and to open the throne to others. This was never proven, because the new Emperor had no reason to inquire too closely into the matter.) The greatest of all Klingon Emperors had won his last battle at the cost of his line and his life, but he lives on as a legend.

The loss of the two major outposts left the Romulans unable to maintain a foothold in the sector, and so they withdrew to an area just outside the disputed territory. The Klingon Empire, now ruled by the temporary regent Kagran, had lost much of its naval might. What forces remained were needed to hold onto current territory. The expansion efforts of both sides slowed to a crawl.

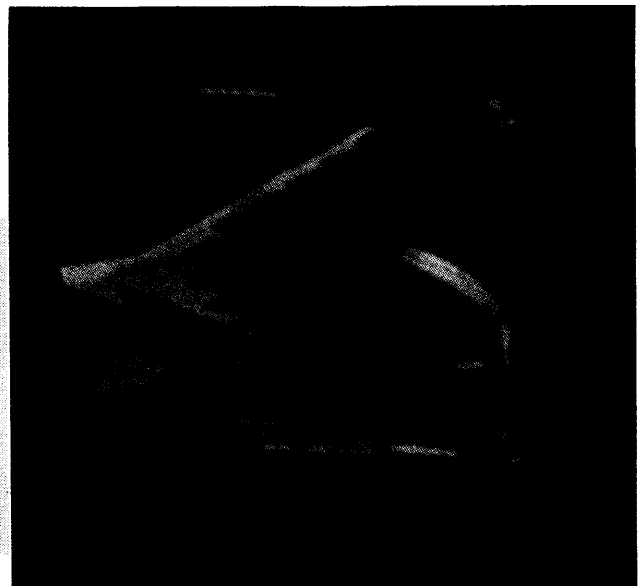

GROWTH OF AN EMPIRE

After the First Klingon/Romulan War, it fell to Emperor Kagran to rebuild the shattered Imperial economy. His strategy was to impose huge taxes on the most powerful lines, which amounted to little more than confiscation of these families' wealth. It is little wonder that Kagran became the first in a long line of assassinated Klingon rulers. The mystery is how he managed to survive for almost 24 years before his son Kader replaced him.

The one legacy of Kagran's rule is a genetic experiment that eventually had a profound effect on Klingon society. In an attempt to understand what made Romulans tick, Klingon scientists fused the genetic structure of their race with that of the Romulans, creating a strain of beings that combined many of the physical advantages of both. The plan was to infiltrate Klingon/Romulan Fusions into Romulan ranks over a period of years, but the scheme was abandoned as too costly in the long run after Kagan's fall from power. The Klingon/Romulan Fusions were sent to the border areas, and aided in many border clashes. Romulan Fusion clans still wield a great deal of power in some of those areas.

Kadar, the new Emperor, was a cautious ruler. The Imperial Council had accepted him purely for the sake of compromise and they only left him on the throne because he was easily manipulated. His reluctance to commit to any clear course of action paralyzed Klingon exploration and exploitation efforts for almost 15 years, however, and led ultimately to his own downfall.

Bored with years of peace, the military eventually forced a confrontation. Marine General Milvi epetai-Javvic seized the throne, the only non-Naval officer ever to do so. Despite his intention to revitalize the Empire's expansion efforts, the Navy was hostile to Milvi, and so he was able to accomplish nothing. Finally, Milvi secured the cooperation of the Imperial Navy by turning over his eldest son to be trained as one of the Navy's own. Kamtav epetai-Javvic succeeded to his father's throne, putting it back in Navy hands once again.

It was under Kamtav's rule that the Klingons made first contact with the Orion colonial governments. In that contact, the Emperor made a fatal error of judgment that permitted the wily Orions to outwit him. Failing to recognize the true scope and wealth of Orion holdings, Kamtav settled for military occupation of a minor trade center in the colony worlds. The Orions offered little resistance, and so the Emperor appointed only a military governor who never really attempted to wield any control over the powerful Orion trade families. The Orions actually benefited from their status as an official Klingon 'protectorate', and the Klingons never committed enough forces to the area to significantly limit the average Orion citizen's freedom. Orion/Klingon trade enriched the Orions, and did bring the Klingons access to resources they needed to rebuild their fleet to better than pre-war size.

The military governorship did not last four full years before being downgraded to a civilian governorship. When the Romulans began new expansion efforts into the disputed areas between the two empires, it forced the Klingons to turn their attention away from the Orion worlds almost completely, though the Orion Colonies remained an important source of war materials. Orion vessels provided the transport of these war materials, which freed Klingon ships for war duty. Though the Emperor believed the idea originated with him, it was actually the Orions who suggested it to

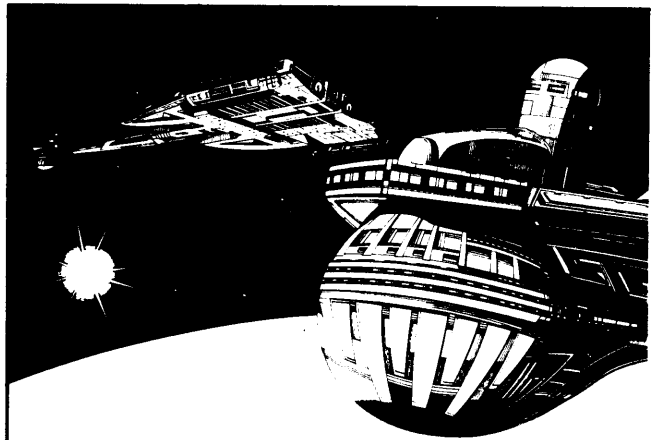

keep Klingon warships out of their space and to maintain their independence from Klingon rule. The expected second Klingon/Romulan War never quite happened, but the Orions used the state of military tension to keep the Klingons turned away from Rigel for quite some time. When the newly formed Federation finally contacted the Orion worlds, the Orions also managed to keep that superpower from encountering the Klingons for many years.

In the meantime, Emperor Karvan had ascended the throne, and had turned the Empire toward other borders. There now began a slow expansion away from Romulan and Orion space, which netted the Klingons many colony worlds and a few servitor races. Among these races were the Jaak, semi-reptilians who had developed telepathy to a high art. Because the Klingons believed any species that could read their minds could not be trusted and therefore could not be controlled, the Imperial Council of powerful lineleaders eventually petitioned the Emperor to have the Jaak destroyed. The order was carried out, using chemical poisons designed to kill reptilian forms. The action strengthened a few large lines who had already liquidated most of their holdings on the planet Jaaketh. The minor line of Havrk was financially ruined by the mass destruction of the Jaak, however. Angered at this downturn in their House fortunes, some members of the Havrk line forced Emperor Karvan into a power struggle that ended with his death in single combat with General Kagga, the line chief of the Havrk.

The succession of the minor lineleader Kagga to the throne did not sit well with the coalition of the most powerful lines in the Imperial Council. They faced a quandary, however, for Kagga was a respected military man who could not simply be eliminated. By right of combat, he was entitled to the throne, but he was also a traitor who must die. The Council resolved the paradox in typical Klingon fashion. Kagga's crown was tattooed about his head and then he was seated as Emperor for one hour—after which, he was executed. (Thus, there arose the phrase "Kagga's Crown", for any painful victory.)

Kagga's death left the succession to the throne unclear. There now followed a period of unrest, with five Emperors either retiring or being assassinated within the next 25 years. This period of uncertainty kept the Empire from benefiting from or even of learning that hostilities had broken out between the Romulans and the Federation, whose existence was still unknown to the Klingons. The Romulan War also kept the Federation too occupied to explore space beyond the Orion systems, which would have revealed the Klingon Empire to them. The succession to the throne of Keth, the longest-lived Klingon emperor, settled the question in time for the Klingons to make a few successful raids against the weakened Romulans.

ENTER THE FEDERATION

Once the Klingons had settled their internal problems, the Orion worlds hastily signed a number of mutual protection pacts with the UFP, knowing that the Klingons would now return in force to the Orion sphere. They did not join the Federation, however, in order to keep open their options. By closing many of their trade connections with the UFP, the Orions again kept the Federation from discovering the Klingon presence. This helped to postpone the inevitable meeting between Humans and Klingons for another 20 years. When it finally occurred, only the Klingons realized the importance of the first meeting.

In 1/3308, Federation Merchant Captain E. A. Jacoby and his crew encountered Klingon traders led by retired naval officer Kassam on an Orion colony world. While the Klingons were pumping Jacoby and crew for extensive information about the UFP, Jacoby realized only that he had met (rather informally and in something of a drunken haze) yet another trading partner of the Orions. He remained unaware that this new race represented the mightiest interstellar empire known. Though Jacoby claimed to have filed the proper reports of his encounter to the UFP Contacts Bureau, those records were never found. Meanwhile, the Klingons, alerted to the presence of what they at first termed "the Human Empire", began squeezing the Orions for information. They watched for lone ships manned by Humans and captured them to make genetic studies of the Human race, with an eye toward the creation of Klingon/Human Fusions. The Klingons hoped that this tactic would serve as successfully as it had against the Romulans.

Klingon agents continued to gather intelligence about the UFP, but it was 18 years before the UFP discovered the Klingons. On Stardate 1/5101.18, the independent trader *Millie Sue* exchanged fire with an unknown scout vessel. Though the trader damaged and chased away the unknown attacker, the exchange left the *Millie Sue* without the capability for faster-than-light travel. Two nearby Star Fleet warships managed to rescue her, but the Federation now began to demand information from the Orions about this aggressive spacefaring race.

The first official UFP/Klingon encounter occurred when the *USS Sentry* confronted the Klingon cruiser *Devvisor* near Gamma Demetrius about four months later, in 1/5105.02. There was only a brief exchange of fire, but the Klingons now began a series of attempts to capture key bits of UFP technology for study. They were actively preparing for war, because the Empire knew that two expansionist cultures would inevitably have to clash. The question was not if, but when.

The first officially recorded hostilities between the UFP and the Klingon Empire occurred on Stardate 1/6110.21. Two Klingon warships fired without warning on the *USS Phantom*, which was patrolling Orion space disguised as a large merchant vessel. The *Phantom* jettisoned its dummy cargo pod and engaged the Klingon attackers, destroying one and crippling the life support system of the other. A boarding party from the *Phantom* attempted to rescue the survivors and to gather information, but the Klingons exploded their ship to avoid revealing too much about themselves. All survivors and the rescue party were killed in the blast.

After this, Klingon warships were more cautious about approaching Federation vessels. All but the boldest commanders avoided UFP convoys, while the Empire began a series of hit-and-run raids to gauge the enemy's strength. This half-war prevailed until Stardate 1/8203, when the Klingon Empire discovered a more urgent problem lurking at their back door.

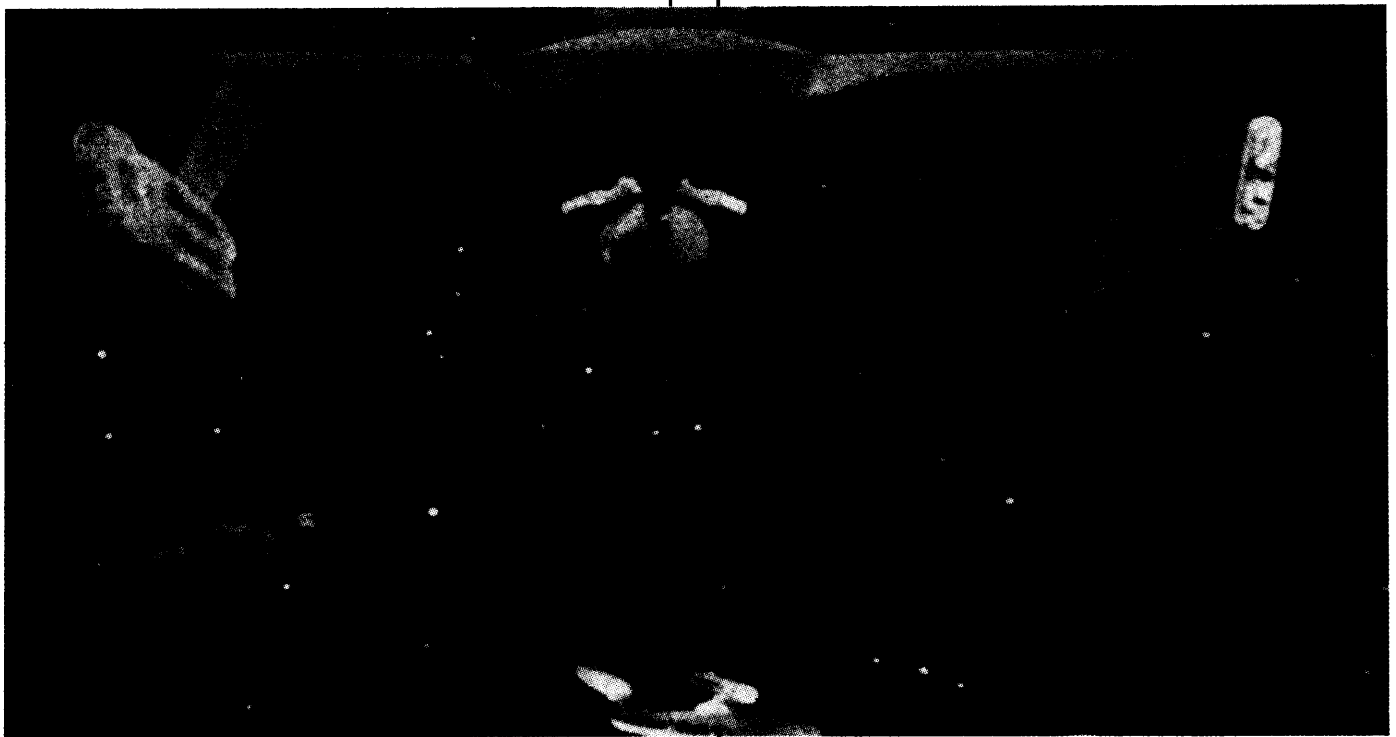

THE DEMON WAR

Klingon expansion along the Empire's coreward border had been relatively peaceful, largely because the Klingons had never encountered any serious challenges. On Stardate 1/8203.04, all that changed.

While exploring a rift area of space where few stars existed, a large Klingon exploratory force disappeared without a trace. An Imperial investigation followed, but then the exploratory force also vanished. Four expeditions later, a single ship returned, commanded by a minor officer named Konj. He reported that deep in the rift, a superior force of vessels of unknown design had ambushed his well-armed scout force. Though the Klingon force had fought well, they were slaughtered by the enemy's globe-shaped black vessels. Konj explained how his own ship, a supply and support vessel, had stayed behind the others, but was able to sweep out to the flank to pick up wreckage from an exploded enemy ship. They brought aboard what appeared to be the body of an alien crewman. Resembling a demon of ancient Klingon legend, the being was covered with short, greenish-black fur and had massive arms webbed with huge folds of flesh, which resembled giant wings.

To the everlasting regret of the Klingon support crew, the alien was still alive. Hardy enough to resist vacuum for long stretches, the enemy soldier awakened from a death-like coma soon after they brought him aboard. With his massive strength and powerful claws, he killed many crewmen, including most of the ship's officers, before he was in turn killed by massed disruptor fire. Had Konj not brought back the body of the dead alien for study, it is unlikely anyone would ever have believed his story. No other ship in his task force escaped slaughter by this new race's powerful vessels.

The Klingons named the race the *Kinshaya* ("demon-possessed") because of their physical prowess and berserk fighting style. The Klingon fleet mobilized along what became known as Demon's Rift. The largest task force ever assembled by the Empire, its mission was to search for and to attack the Kinshaya. Instead, the Kinshaya fleet found its way out of the Rift and attacked a major Klingon base scant days before the task force was to be deployed.

The resulting war was the bloodiest in Klingon history. Between Stardates 1/8203 and 1/8703, the Demon War occupied all available Klingon forces in a fight, literally, for the survival of the Klingon race. Though the Kinshaya were the closest thing to a nightmare the Klingons had ever faced, here at last was an enemy the Klingons could totally understand psychologically—a race that would destroy any being not of their own kind. The Kinshaya ships matched or exceeded the capabilities of Klingon vessels, far outclassing even the new multi-purpose *D-7A*.

Though the Kinshaya were singleminded in battle, never surrendering and never giving up, it was this very quality that helped the Klingons even up the odds. Simply put, the Kinshaya seemed not to understand the concept of strategic defeat. When their considerable battle losses eventually forced them to slacken the pace of attack, the major fighting began to wind down into scattered warfare. The border incidents, skirmishes, and other hostile encounters between the two races continue to this day, but neither side has attempted to escalate again to a second all-out war.

To maintain a strong military presence against the Kinshaya, the Klingons built up their forces, adding newer, more powerful capital ships to their fleet. These were soon to prove just as useful against another dangerous foe.



THE FOUR YEARS WAR

Though their coreward expansion was blocked by the presence of the Kinshaya, the Klingons had now impressively built up their fleets because of the Demon War. Because the Empire must either grow or die, some Klingons turned their sights toward their rimward border, which lay along Federation space, believing that the Empire could easily overwhelm the UFP.

Emperor Karhammur, however, did not wish to risk another failure in another war. Militant factions of the Council continued to apply pressure, and so the *komerex zha*, the Great Game of Empire, soon was running at full steam once more. The Emperor was forced to prepare for combat, because he wanted to avoid a split in the Council that could lead to his assassination.

When the UFP showed a willingness to negotiate, the Klingon High Command interpreted it as a sign of weakness, further proof that they could overcome this foe. Meanwhile, the High Command had mapped out a plan to seize and hold a key area of UFP-controlled space with minimum casualties. To carry out the plan successfully, the Klingons would need to infiltrate a small fleet into UFP space, and they chose the planet Axanar as their base. There, they could secretly establish a biogenetic laboratory to develop a Klingon/Axanarian hybrid race, which would become an ally to divide the UFP's attention in the coming battle. (To this day, the UFP does not recognize this purpose of the Axanar expedition. See FASA's adventure scenario **Return to Axanar** for the story, and **The Four Years War** for a more detailed examination of the UFP view of this incident.)

On a mission to evaluate Axanar's sociological development in 1/9403, the *Sawyer Class USS Gulliver* accidentally discovered the Klingon presence in Federation space. Though the *Gulliver* was destroyed, this encounter tipped the Klingons' hand before they were ready to implement their plan. Two months later, the *USS Xenophon*, under Fleet Captain Garth, fared better, disabling a Klingon cruiser eight parsecs from Axanar and then diverting to Axanar in time to monitor the growing Klingon task force.

Though badly outnumbered, Garth's small fleet of ships defeated the Klingon fleet at the Battle of Axanar in 1/9408.29. Klingon Admiral Kkorhetza refused to withdraw, declaring an alliance with Axanar against the UFP. With war formally declared, Garth and Kkorhetza met again on Stardate 1/9409.30 in the Second Battle of Axanar, during which Kkorhetza was defeated and forced to surrender.

Almost from the very first day, the Klingons fought a war of power rather than tactics. With the High Command firmly convinced that they might yet break the UFP's spirit, they committed ship after ship and fleet after fleet to punishing frontal assaults against UFP positions. At first, they were winning through sheer numerical superiority. The Klingons would eventually fall before the UFP's superior tactics, however. The Attack of Convoy Y-162 near the Rebonet system was the first genuine Federation fleet victory, and showed what the UFP could do with strategy when the numbers were in *their* favor.

The Klingons wasted too much strength early in the war, leading to chaotic disorganization and a lack of reinforcements in the later stages. By Stardate 1/9705, they had made their deepest penetrations into UFP space, but it was a line they could not hope to hold. Newly constructed Star Fleet ships and the development of the phaser and photon torpedo by busy UFP science teams late

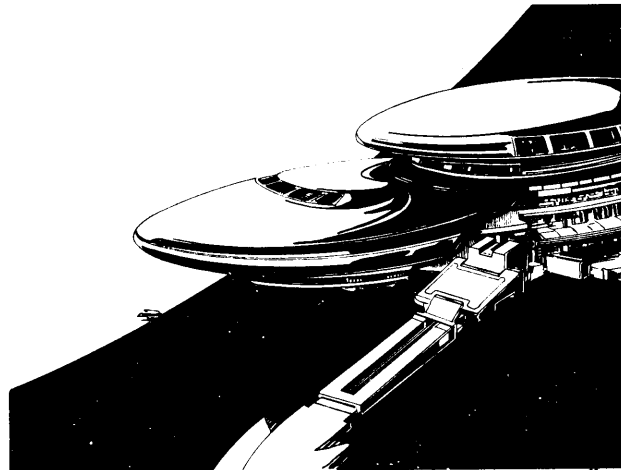

in the war sealed the Klingons' fate. Having learned that the Klingon defenses were centered at the planet Kolm-an, the UFP mounted a massive assault, Operation Argus Redoubt. This operation broke the back of the Klingon resistance.

Ironically, it was Emperor Karhammur who took the brunt of the blame for defeat in a war he had never wanted in the first place. The target of a failed coup attempt during the war, Karhammur watched as his rival for power, Admiral Kamato, escaped Klingon justice and fled into the Triangle. There, Kamato founded the Imperial Klingon States, an independent government claiming to be the legitimate Klingon government in exile. Karhammur had too many enemies, however, and was forced to abdicate soon after the Treaty of Axanar ended the Four Years War.

POST-WAR PERIOD

Federation colonists began flooding almost immediately into the new territories won by the Treaty of Axanar. As the tide of settlers grew, it moved ever closer to Klingon space. Indeed, many civilian vessels, explorers, scouts, and colonial transports began to cross the border in their search for a new life on the frontier. Though the Klingons destroyed many of these intruders to the last man, it did not stem the tide. Population pressure was building on the Federation's coreward border, and sooner or later, something would have to give.

The Klingons, meanwhile, had begun almost immediately to rebuild their military strength, driven as much by the fear that the Romulans would take advantage of their weakened stance as they were by the pressure on their border with the Federation.

The rebuilding took ten years, during which time the Klingons never forgot the humiliation they had suffered at the hands of the UFP. Klingon/Human Fusions used this period to gather power, which divided the Empire into the Inner Empire, controlled mostly by the Imperial Race, and the Outer Empire, controlled mostly by Fusions. By this time, Imperial Race Klingons were rarely seen along UFP borders.

Construction of a major new naval star fortress on the planet Mastocal was completed by Stardate 2/0109. The UFP was not idle along the borders either, completing the new Star Base 27 facility more than a year earlier. When the Mastocal base opened, the Federation responded by beginning construction of Star Base 12, which became operational in Stardate 2/0705. By this time, both sides were ready for war, almost eager to get it over with once and for all. It was not to be.

ORGANIAN CONFLICT

The Klingon High Command decided on a different tactic to begin what they believed would be the last war with the Federation. While skirmishing all along the border with the Federation, the Klingons chose Organia, a peaceful agricultural world populated by Human-like pacifists, as the target for a massive ground action that would secure the planet as a supply center for their next massive thrust into UFP space. UFP security was better than the Klingons dreamed, however, and the Federation dispatched the cruiser *USS Enterprise* to warn the Organians of the invasion and to offer an alliance.

An acceleration of the invasion timetable placed the *Enterprise* alone on the scene when Commander Kor and the Klingon invasion fleet arrived. The outgunned cruiser was forced to withdraw, stranding Captain James Kirk and First Officer Lieutenant Commander Spock on the surface. The two tried to mount a two-man guerrilla war against the invaders, but were unable to interest the pacifistic Organians in resisting the Klingon occupation forces.



Yet, all was not as it seemed. Faced with possible harm coming to the two Star Fleet officers, and the return of the *Enterprise* with reinforcements to challenge the Klingons in orbit, the Organians revealed their true nature as powerful energy beings with great mental powers. They forbade the two sides to fight, disabling the weapons of both fleets. This angered both sets of commanders, whose respective vast military powers were now useless.

In this way, the Organians forced the Klingons and the Federation to accept the Organian Peace Treaty. That treaty forbade military action along the Klingon/UFP border extending from the Orion Colonies well into the unexplored frontier. The Organians used their power to enforce this treaty, whose intention was to protect the rights of sentients in the area. Uninhabited worlds would be awarded for colonization and exploitation to either the UFP or the Klingons, based on which could most efficiently develop them. The two superpowers had no choice but to accept the treaty, for the Organians promised to disarm *both* sides in the event of further hostilities.

The whole affair annoyed the Federation, but it positively demoralized the Klingon Empire. For the first time in Klingon history, they had met a foe against whom physical force was not only useless but *impossible*. The very existence of the Organian race dealt a crippling blow to the belief system that supported Klingon culture. Though every living Klingon would deny it, their whole race feared the Organians, who were powerful beyond belief, and pacifistic beyond comprehension. The Klingon mind could not conceive of the two traits coexisting. Though the treaty did not apply to the short Klingon/UFP border between the Orion colonial holdings and the Triangle, the Klingons initially laid low in that area, except for a few minor border skirmishes. They were afraid that the Organians would extend their control to the Neutral Zone as well.

After a period of vast reorganization, the Klingon Empire reacted to the situation in the only sane way an organism can respond to an intolerable state of affairs—they ignored it. The situation was such a blow to Klingon pride that they had to tell themselves that they were voluntarily cooperating with the Organian peace effort in order to gain an advantage over the UFP.



In fact, it was this illusion that gave the Klingons an early advantage in the development of worlds in the Treaty Zone. Klingons are both pragmatic and efficient by nature, and so they changed their tactics from the rape of worlds to the careful cultivation of every single scrap of resources they could obtain from them. Indeed, their efforts were so masterful that at first they outdid the UFP.

In addition, the Klingon military turned the pent-up resentment of their treaty-bound officers into a desire to embarrass and interfere with the UFP at every opportunity. Battle leaders quickly became agents of espionage and deceit. Frontal assaults gave way to sabotage, and declarations of war to a battle of nerves. At this, too, the Klingons proved adept. They simply accepted that the rules had changed, but knew that the Great Game still continued in a quieter, subtler, and perhaps even more dangerous way.

KLINGON/ROMULAN ACCORDS

It was this shift in Klingon Imperial policy that made the Emperor and the Imperial Council take another look at their relations with the Romulan Star Empire. The Klingons concluded that they could use this ancient foe as a wedge against the UFP, if the game were properly played. Within a year of the signing of the Organian Peace Treaty, the Empire was also drafting a series of secret agreements with their former adversaries, the Romulans.

Because the UFP had been a source of never-ending technological surprises, the first series of Klingon/Romulan agreements dealt mainly with technological exchange. The two governments believed that by pooling their sciences they would no longer be at a high-tech disadvantage against the UFP. The Romulans, chronically short of ships, got a number of *D-7* Class vessels (and built more based on them), while the Klingons received technical data on Romulan plasma weapons that eventually permitted them to match Federation photon torpedo weaponry with a similar system of their own.

Klingon/Romulan relations did not actually improve, however. In fact, border incidents between the two continued at the same steady pace. Over the next ten years, more Klingon/Romulan agreements bolstered each side, but it was only a case of two deadly enemies realizing they needed one another to survive against a third common foe.



DECLINE OF FUSION INFLUENCE

While the Klingon Empire was gradually rebuilding its strength to pre-war levels, more and more Imperial Race Klingons came into power in the Imperial Council, with Human and Romulan Fusion lines falling from favor. This resulted in more militant policies. Though the Empire still dared not challenge the Organian Treaty directly, hostilities and border incidents along the Neutral Zone border between the Triangle and the Orion Colonies increased. Both the UFP and the Klingons reinforced their military presence in this area again and again.

By Stardate 2/2001, Imperial Race Klingons were back in control of most of the military forces on the UFP/Klingon borders. Some Klingon/Human Fusion subtlety still remained in the High Command, which had a slight tempering influence on natural Klingon aggressiveness. Meanwhile, word filtered into the Empire from an Imperial Intelligence agent named Valkris, who had learned of the power of the Federation's Genesis Device. An ambitious Klingon commander named Lord Kruge used his family position and influence to take command of an expedition to obtain the details on the device directly from Valkris, who had once been Kruge's lover.

In 2/2206 and on his own authority, Kruge pursued the Genesis secret to the Mutara system, where the device was inadvertently detonated. Kruge and the small crew of his *K-22B Bird of Prey* scout intercepted and destroyed a research vessel of the UFP, and then challenged the *USS Enterprise* itself for the plans to the Genesis Device. The *Enterprise*, acting against orders and manned only by a handful of officers, was lost, but the surviving crew captured Kruge's own vessel. Kruge himself was killed on the Genesis Planet, and his vessel (with its top-secret version of the Romulan cloaking device) was delivered intact to Vulcan. The failure of this mission dealt a crippling blow to Imperial Race prestige once again.

Three months later, Kiltarc zantai-Neygebh, Klingon Ambassador to the UFP, arrived on Terra. In a meeting attended by a select group of Federation Council members, ranking Star Fleet officials, and Federation Supreme Court Justices, Kiltarc branded Admiral James T. Kirk as a pirate and interstellar criminal for his role in the Genesis Incident. Claiming that Kirk endangered peace in known space, the Klingon ambassador demanded that the Admiral be turned over to the Klingon Diplomatic Corps to stand trial in the Klingon Empire for his crimes.

The Federation Council President replied that if Kirk was to stand trial, it would be within the Federation and under Federation jurisprudence. At that moment, Kirk was immune to prosecution because the Vulcans had offered him political asylum.

Kirk and his party did eventually return to Terra to face courts-martial. After extensive interrogation and cross-examination, however, the Court decided that Kirk's crimes were balanced by his heroism. His crew were not punished, penalized, or demoted in any way, but Kirk was demoted to Captain.

Klingon Ambassador Kiltarc abruptly left Terra and returned home to the Empire.

TIMELINE

Stardate -12/01 ca.

The first Klingons develop on Klinzhai from primate-like ancestors.

Stardate -9/55 ca.

Large extended-family tribal units are organized.

Stardate -6/80 ca.

Split between sea-dwellers and land-dwellers occurs, with little contact between the two after this date until the Great Consolidation centuries later.

Stardate -4/37 ca.

Development of the *komerex Nevre* (Northern Empire) and *falgav a'kavna* (Crescent Islanders) as the two major sociopolitical groupings among the sea-going peoples of Klinzhai. Wars rage between these two groups for decades before the Northern Empire swallows up the Crescent Islanders in about Stardate -4/60. The new sea-going empire begins a series of actions against the land-based *komerex Klingon* (Empire of the People) that will last for centuries.

Stardate -1/0110

The former Northern Empire (now known as the *komerex dexiKlingon*, or Empire of the True People) develops nuclear weapons and attacks the capital of their land-based foe with their one operational bomb. Within three years, the land-dwellers, sparked to new heights of outrage and hatred, overwhelm the sea-dwellers completely. In the end, many sea-dweller leaders switch sides and become naval commanders in the *komerex Klingon* (Klingon Empire), which soon controls the entire planet. In this era, the first Klingon space explorations take place. Scientists had long theorized that Kobek was the only other habitable planet in the system, and it was colonized in this period.

Stardate -1/4812

A planned rebellion on Kobek is put down decisively, but the detonation of the Kobek weapons stockpile destroys all life on that world, and changes its orbit.

Stardate -1/8804

Forty years after the Kobek detonation, that poisoned world finally breaks up from the tidal stresses of its new orbit.

Stardate -1/9001

Kahless epetai-Riskadh launches the daring coup that makes him the first sole Emperor of the Klingon Empire. The nearly perfected warp drive soon points the Empire toward the stars.

Stardate -1/9403

Natives of Delta Khinah II become the first Klingon servitor race.

Stardate 0/0001.30

The Romulan scoutship *L'Sattak* returns for the second Romulan survey of Delta Khinah, and discovers the Klingon presence there. The scoutship is destroyed, but not before transmitting its log tapes to a colonization convoy trailing it by 20 solar days. With days to prepare, the large Romulan force obliterates the small Klingon garrison at Delta Khinah II, starting the first Klingon/Romulan War on Stardate 0/0002.01.

Stardate 0/0306.15

Klingon forces crush Romulan resistance at their two major outposts, forcing a Romulan withdrawal from the disputed area. Emperor Kahless is killed in the final battle, and the Riskadh line ends, along with the First Klingon/Romulan War.

Stardate 0/0402.22

Kagran epetai-D'kariv, temporary Imperial Regent, officially takes the throne after being confirmed by the Imperial Council. Within two years, he has ordered six new taxes to pay for a secret breeding experiment that fuses Klingon cells with certain Romulan genetic material. Though the breeding experiment is unpopular at first, it proves useful in infiltrating Klingon agents into Romulan-held areas.

Stardate 0/0912.21

The Romulans begin a period of slow, cautious expansion in the direction of the Klingon Empire. The expansion ends 40 years later, setting the boundaries for what is today known as the Triangle, where many of the recurring skirmishes between these two powers and the UFP take place.

Stardate 0/2802.10

Kagran's son Kadar succeeds to the throne as a compromise candidate to quiet conflict between factions in the Imperial Council. Kadar spends much of his reign trying to keep all sides content, resulting in little real exploration and expansion for the next 15 years.

Stardate 0/4211

Growing dissatisfaction among the military finally forces the D'kariv line from the halls of power. General Milvi epetai-Javvic of the Imperial Marines takes the throne, the only non-Naval officer ever to hold that office. He begins exploration funding again, but the Imperial Navy opposes him at almost every turn. To regain control over the entire military, Milvi agrees to let his oldest son be trained as an officer of the Imperial Navy, thus assuring that the next Emperor will again be a naval officer.

Stardate 0/5807

Kamtav epetai-Javvic succeeds his father on the Imperial throne, and carries on with the exploratory efforts. The Klingon military backs the new Emperor, and so conquest begins anew.

Stardate 0/7202

The Orion colonial governments make first contact with the Klingon Empire. They cleverly conceal the real value of their location in space and their mineral wealth, however, avoiding Klingon domination by convincing the Empire that the Orions have more to offer as independent allies. After a minor show of force, the Council assigns a figurehead Klingon governor to the Orion Colonies; he never actually attempts to exercise control, and his position is mostly that of a trade liaison. The average Orion is totally unaware that the colonies are 'officially' a Klingon protectorate. They do recognize a rich new market when they see one, and so start to trade with the Klingons. Meanwhile, the controlling Orion trade families remain watchful to assure that the Empire does not become too interested in Rigel's wealth.



Stardate 0/7312

Emperor Karvan orders the destruction of the Jaak, a semi-reptilian servitor race of telepaths, because he finds them too untrustworthy. A power struggle results, with Karvan caught in the middle. Finally, the Emperor is slain in single combat by General Kagga, a respected military leader holding commissions in both the ground forces and Imperial Navy. Kagga's prestige gains him the throne—for exactly one hour, after which he is executed for treason. There will be five weak Emperors chosen and removed in the next 25 years, and many of the recently resumed colonization efforts again fall idle.

Stardate 0/7610

The Klingons withdraw their figurehead governor from the Orion worlds, beginning a period of benign neglect. Conflict has heated up between the Romulans and Klingons along their common border (though no war is ever actually declared), leaving the Empire no time for an area it perceives as only marginally useful. Klingon trading vessels become rare in Orion space, with the Orions using their own vessels to conduct most of the trade in war materials with the Klingons. The Orions claimed that this would free Klingon vessels for war efforts. Their real reason for suggesting the policy was to rid their space of the Klingon presence in order to build up their own military more effectively without tipping the Empire to their actual strength.

Stardate 0/8706.06

The Articles of Federation are signed, but the Rigel/Orion interests do not join the Federation, thus avoiding restrictive entanglements for the time being. The Orions also maintain the secret of the existence of the Klingon Empire. The Klingons are just one of many cultures with whom the Orions trade, and so they continue to go unnoticed by the newborn Federation.

Stardate 1/0003

The ascendance of Keth epetai-Rivaki to the Imperial Throne begins a new era of Klingon expansionism and prosperity.

Stardate 1/0910

By this time, the Klingons have begun to perfect shipboard disruptor technology, which they are deploying throughout their fleet. With the Romulan War now over, the Orions realize that the UFP and the Klingon Empire must eventually encounter one another. At this moment, however, the Klingon military is occupied with raids against the weakened Romulan border. The Orions nevertheless fear that the Klingons will soon turn their attention again in the direction of Rigel and her interstellar holdings. Realizing that any contact between the UFP and the Klingon Empire must inevitably lead to armed conflict, the Orions hastily negotiate several non-aggression and trade treaties with the UFP, but still do not join the Federation.

Stardate 1/1818

Most Orion trade families close their operations with the UFP, in the face of Klingon trade vessels returning to the Rigel colonies. Through masterful timing of ship arrivals, the Orions keep the Klingons and UFP unaware of each other's presence for many years, despite UFP displeasure at the closing of many Orion ports.

Stardate 1/2412

Faced with threats that the UFP will revoke its non-aggression agreements because of the closure of Orion ports to even emergency traffic, the Orions reopen their ports to UFP shipping on a limited basis. They also sign new treaties with the UFP. These agreements provide the Orion worlds with a promise of protection from outside aggression, but bind the Orions only to *not directly* attacking the UFP. This opens the door for the Orions to trade with both sides if and when the Klingon Empire and UFP meet in conflict.

Stardate 1/3308

The Federation merchant captain E. A. Jacoby and his crew encounter some Klingon traders led by retired Naval Officer Kassam on an Orion colony planet. The traders are aware that they have made contact with a previously unknown species, but the Klingons hide the true importance of the incident, all the while pumping the traders for information on the UFP. As an experienced trader, Captain Jacoby has encountered a number of new races (all customers of the Orions) in past visits to Orion ports, and so he simply passes along the routine UFP contact material. Though Jacoby claims to have filed the proper reports to the UFP Contacts Bureau, those records are never found. Meanwhile, the Klingons begin a crash program to learn all they can about this potential rival that they call the "Human Empire". They capture a number of Federation ships, interrogate the crews, and begin exploring the possibility of creating Klingon/Human genetic fusions.

Stardate 1/5101.18

Though any number of independent traders have encountered Klingons in Orion ports, the UFP has never taken official notice of this new culture, whereas Klingon military observers have been gathering data about the UFP and Star Fleet for years. On this date, the independent trader vessel *Millie Sue* and a Klingon scout vessel exchange fire. Though the *Millie Sue* damages and chases away the attacking ship, the exchange leaves her without faster-than-light capability. Two Star Fleet warships respond to the trader's distress call and rescue all hands. A nearby Klingon destroyer class ship, sent to aid the Klingon scout, evades the larger Star Fleet vessels. The encounter leads the UFP to press Orion sources for information on this previously unknown spacefaring race.

Stardate 1/5105.02

The *USS Sentry* encounters and confronts the Klingon cruiser *Devisor* near Gamma Demetrius. A brief exchange of fire marks the first official contact between the UFP and the Klingon Empire.

Stardate 1/6003.04

The *USS Flying Fortress*, a prototype slow transport, is hijacked in space by a Klingon war vessel. A Federation anti-piracy force intercepts the hijackers as they are towing the vessel away, and forces the Klingons to release their tractor beam and flee. The badly damaged *USS Flying Fortress* is recovered.

Stardate 1/6110.21

Star Fleet disguises a number of warships as merchant vessels in a ploy to draw out the Klingon Empire for another attack. One of these vessels, the *USS Phantom*, is fired upon without warning by two Klingon warships in Orion space. The *Phantom* jettisons its dummy cargo pod and engages the Klingon attackers, destroying one and crippling the life support system of the second. A boarding party from the *Phantom* attempts to rescue survivors and gather information, but the Klingons explode their ship to avoid revealing too much, killing all survivors and the rescue party. Without substantive evidence to link the attack to the (largely still mysterious) Klingon government, the UFP can take no direct military action. The deceased commanders of the two destroyed ships are awarded Imperial Commendations, and their lines gain much in status.

Stardate 1/8203

The so-called Demon War between the Klingons and the alien race known as the Kinshaya begins along the coreward border of the Empire. The Empire diverts fleets and material from the Federation and Romulan borders to meet the threat from the Demon's Rift.

Stardate 1/8610

Klingons encounter Romulan ships equipped with cloaking devices, which the Star Empire has recently perfected and is using for the first time on its border areas.

Stardate 1/8703

The Demon War ends with a whimper instead of a bang. A state of prolonged but stalemated hostility exists between the two races, with no end in sight. It is almost three years before the Klingon military presence along the borders with the UFP and Romulan Star Empire is back to its pre-war strength, though the Demon War did see the introduction of several new ship designs. Klingon/Human Fusion lines gain control of most of the UFP/Klingon border areas.

Stardate 1/9001

With dreams of expanding into Federation-held space, Emperor Karhammur orders the construction of a biogenetic laboratory on the planet Axanar, with an eye toward creating Klingon/Axanarian Fusions to eventually act as a second force against the UFP. Planning begins on a series of minor skirmishes to divert UFP attention away from Axanar.

Stardate 1/9212.21

The *USS Bohr* reports observing a three-ship Klingon task force in unclaimed space between the UFP and Klingon spheres of influence. The small task force is a decoy to lure the *Bohr* from its patrol area and to allow a 20-ship force to attack the Arcanis research station. The massacre of 112 UFP citizens begins a chain of events that will lead to war. Having detected two massive Klingon battle fleets in the following two months, the Federation begins to prepare for war, but hostilities do not begin immediately. Meanwhile, all this is a blind to distract the UFP from Axanar, the true target of Klingon interest.

Stardate 1/9408.29

Captain Garth of Izar defeats a Klingon reinforcing fleet headed for the Axanar system, preventing the Klingons from establishing a supply line to forces already massed there. Unaware of the results of the First Battle of Axanar, and secure in the belief that the Axanar research facility is safe, the Klingon Empire declares war on the UFP exactly one month later, on Stardate 1/9409.29. At the Second Battle of Axanar, Garth (his small command now reinforced by Star Fleet) defeats the Klingon invasion fleet at Axanar.

Stardate 1/9705

Forces of the Klingon Empire make their deepest penetrations into Federation space at the Battle of Thranstor, but the Klingon fleet, led by Admiral Kamato, is eventually routed by a reinforced Federation fleet armed with the new phaser weapons. Following the defeat, the line of Admiral Kamato attempts a coup to seize the throne, blaming the defeat at Thranstor on a lack of Imperial support. Though the coup fails, Kamato escapes with his remaining loyalists into the Triangle area.

Stardate 1/9709.10

Kamato and his line found the Imperial Klingon States in the Triangle. Declaring itself to be the "rightful" Klingon government in exile (after a failed coup), the IKS becomes a major source of intelligence against the Klingon Empire for the rest of the war.

Stardate 1/9712.06

Believing that the Klingons must stop the war now in order to strengthen themselves to fight again another day, Admiral Komex surrenders himself to UFP authorities and informs them of the location of the two major Klingon supply bases in the disputed area.

Stardate 1/9803.20

In the Battle of Kolm-an, the UFP deals a crushing blow to Klingon supply and repair capability, forcing the Empire to sue for peace.

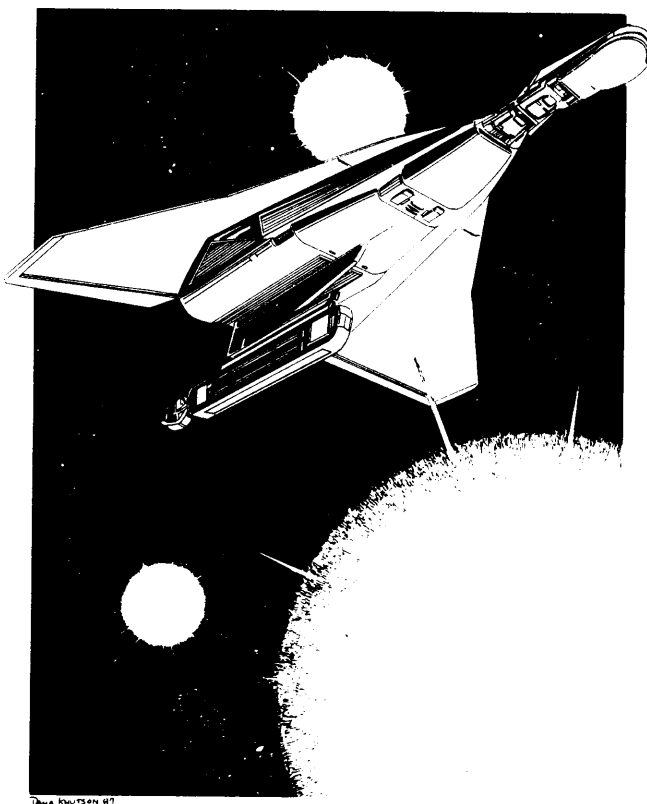

Stardate 1/9806.13

The Four Years War ends with the signing of the Treaty of Axanar. A major force in the treaty negotiations, Admiral Komex refuses the UFP offer of asylum and voluntarily returns to Klinzhai after the war. He redeems his line's honor by presenting himself formally to the Emperor for judgment, and is executed in single combat by Kassa, the Imperial heir. Komex's claim that he was acting to end a war that was destroying the Klingon Empire's ability to rebuild does hit home with some influential lines, forcing Karhammur to abdicate the throne in favor of his son soon after the war. His son starts a new line of his own, and the new Imperial Household begins to rebuild Klingon military might.

Stardate 2/0109

Completion of the new Klingon naval base at Mastocal marks the beginning of a return to a pre-war level of battle readiness. By Stardate 2/0706, the Klingon Navy is larger and more powerful than ever before, and so Emperor Kassa pronounces the Empire again ready for war. The Klingons choose a potential supply base for a new invasion of the UFP. It is the agricultural world of Organia, inhabited by a race of Humanoid pacifists.

Stardate 2/04

Federation and Klingon forces clash along a wide expanse of space claimed by both sides.

Stardate 2/0801.06

A Klingon battle group under the command of Captain Kor seizes the planet Organia and transports occupation forces to the planet's surface. The *USS Enterprise* responds to the threat to Organia. Captain Kirk and his First Officer are captured after attacking Klingon military installations on Organia.

Stardate 2/0801.09

As a Star Fleet task force approaches Organia, the Organians reveal themselves as enormously powerful energy beings and intervene to end the conflict. Using their mental powers, they render the two enemy fleets helpless in space, then later impose the Organian Peace Treaty on both sides, thus averting a second Klingon/UFP war. The Organian Treaty Zone is established by negotiation over the next three months. This new zone makes important changes in the Klingon/Federation border and results in additional territory for both governments. Although both sides honor the treaty, the fate of various 'orphaned' planets in the Neutral Zone remains unresolved.

Emperor Kassa commits suicide, unable to bear the shame of being defeated in such an ignominious manner by a pacifist culture. His heirs begin a period of reorganization, and Imperial policy begins to make a subtle shift from conquest by force to conquest by economic domination.

Stardate 2/0901

The Organians decide to discover whether or not Humans and Klingons can live and work together. They select Sheridan's World as the site of an experimental colony composed of both Humans and Klingons. Should the project succeed, the Organians will consider lifting many of the restrictions to developing other worlds in the region.

Stardate 2/0902

The first Romulan/Klingon non-aggression and technological treaties are signed at Villiam III, near the Triangle. Fearing the growing military might of the UFP, the Romulans and Klingons decide to concentrate on this common enemy.

The Romulans, currently ahead in territory, give up many disputed planets as well as plans for an older model cloaking device and the plasma weapon. In return, the Klingons provide the Romulans with a number of older *D-8* ships equipped with Klingon weapons and engines. Talks continue, leading to a series of such agreements, but there is no real reconciliation between the two governments.

Stardate 2/1109

The second Romulan/Klingon treaty is signed. The Romulans gain bases coreward of the Triangle. The Klingons gain a much-desired, mineral-rich planet in the Triangle itself. Both sides feel they have come out ahead.

Stardate 2/1202

The Kinza D'elma naval base is complete. The base is built in territory acquired under the Organian Treaty.

Stardate 2/1204-1210

The Klingons increase aggression outside the Organian Neutral Zone, to which Star Fleet responds with vigilance.

Stardate 2/1403

A Klingon task force engages a Romulan task force near the Triangle. This skirmish, involving a total of eleven starships, demonstrates many flaws in the newly designed Klingon *L-13* Class battleship.

Stardate 2/1702.26

A strange electrical cloud appears near the Klingon base of Mera Zine. Three Klingon *D-7M* Class cruisers attack the cloud and are instantly vaporized, proving the object is capable of incredible destruction. (So begins the V'ger Incident, on which *STAR TREK: The Motion Picture* is based.)

Stardate 2/1801

The third Romulan/Klingon treaty is signed. The Romulans gain access to new weaponry and advanced mining equipment. The Klingons gain a twelve-man scout-size *Bird of Prey*, which they put into widespread use as a raider, and on which they base several large ship designs of their own.

Stardate 2/1805

The Romulans deliver several *S-11* Class scouts to the Klingons as part of a technological exchange treaty. This vessel, re-equipped with Klingon shipboard systems, becomes the *K-22A Bird of Prey* Class scout.

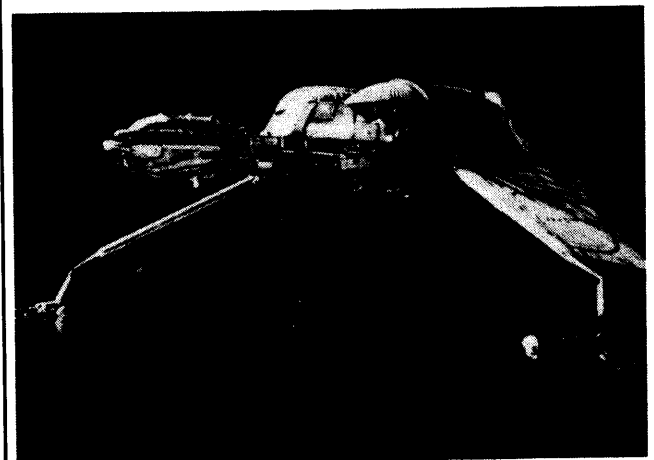
**Stardate 2/1906**

The *K-22B Bird of Prey* Class scout enters service.

Stardate 2/2001

The decline of the influence of Klingon/Human Fusions is complete, with most territories along the UFP borders now in the hands of more militant Imperial Race family lines. Border incidents along the UFP/Klingon Neutral Zone (lying between the Triangle and the Orion colonial systems) become more frequent and more deadly. Star Fleet begins refurbishing older ships and taking a more militaristic stance.

Stardate 2/2004

The Organians announce that Sheridan's World, site of the joint Human-Klingon settlement, will be opened to authorized visitors in one standard year.

Stardate 2/2104

The Organians permit mission teams from the Klingon Empire and the Federation to visit Sheridan's World. One week later, the colonists will vote on whether to join the Federation, join the Klingon Empire, or become a fully independent world.

Stardate 2/2107.16

Admiral Randolph Morrow informs all Star Fleet vessels that "According to information obtained by the highest levels of Star Fleet Command, the race of energy beings referred to as the Organians have ceased their enforcement of the Organian Peace Treaty." Apparently, the Organians will no longer intervene in any actions between the Federation and the Klingon Empire, which means that interstellar war is again possible.

Stardate 2/2206.24

Klingon Captain Kruge, commanding a cloaking device-equipped *K-22B Bird of Prey* Class scout, destroys the *Gagarin* Class *USS Grissom* and all aboard. Doctor David Marcus, Lieutenant Saavik, and a partially regenerated Spock, all on the surface of the Genesis Planet, survive.

**Stardate 2/2206.25**

A landing party of several Klingons beams down to the Genesis Planet. Upon reaching the planet, the *Enterprise* discovers the *Grissom* has been destroyed. The *Enterprise* exchanges fire with the Klingon scout, but cannot finish it off. In response, a Klingon kills David Marcus on the Genesis Planet. Admiral Kirk tricks Captain Kruge into sending a boarding party onto the *Enterprise*, which he then causes to self-destruct. Kirk kills Kruge on the planet.

Before his death, Imperial Security Officer Karamark vestai-Treth secretly transmits a copy of the Genesis data obtained by Kruge to his superiors on Klinzhai. Kirk, Sulu, Saavik, McCoy, Chekov, and Scott escape aboard the Klingon scout with the regenerated Spock. Maltz, the *Bird of Prey's* First Officer, is also taken into custody. The Genesis Effect proves its instability and the Genesis Planet disintegrates.

Stardate 2/2209.26

Kiltarc zantai-Neygebh, Klingon Ambassador to the UFP, arrives on Terra. He meets with a select committee of Federation Council members, ranking Star Fleet officials, and Federation Supreme Court Justices. Describing Admiral James T. Kirk, in his role in the Genesis Project, as a pirate and interstellar criminal who has recklessly endangered peace in known space, Kiltarc demands that Kirk be turned over to the Klingon Diplomatic Corps to stand trial in the Klingon Empire for his crimes. The Federation Council President responds that if Kirk is going to stand trial anywhere, he will do so within the Federation and under Federation jurisprudence. At the moment, however, Kirk is immune to prosecution while receiving political asylum from Ambassador Sarek on Vulcan.

Stardate 2/2209.27

Admiral Kirk and his party leave in the Klingon *Bird of Prey* for Terra, where all (except Spock) face courts-martial for the theft and destruction of the *USS Enterprise*. By this time, both Captain Spock and Doctor McCoy have recovered fully from the *fal tor pan* process.

Stardate 2/2210.14

After extensive interrogation and cross-examination, the courts-martial of everyone involved in the *Enterprise* theft are now complete. It is the Court's decision that Scott, Sulu, Uhura, McCoy, and Chekov were only following the orders of Admiral Kirk, and so they will not be imprisoned, demoted, or penalized in any way.

The Court rules that Admiral James T. Kirk, acting from a sense of loyalty and duty, was still personally responsible for the spacejacking and subsequent destruction of the *USS Enterprise*. However, his actions also led to the capture of a Klingon warship, the successful recovery of Captain Spock, and the resolution of the Cetacean Incident. For this reason, the Court sentences Kirk to formal chastisement and a two-grade demotion to Captain, which will also return him to the field as a starship commander.

Stardate 2/2210.17

Klingon Ambassador Kiltarc abruptly leaves Terra and returns to the Klingon Empire.

Stardate 2/2302

Klingon border commanders begin to receive more ships to beef up their fleet strength.

Stardate 2/2304

More heavy cruisers and the first two *L-24* Class XIII battleships produced arrived at the Klingon/UFP border area. Believing that the Federation now has ships armed with "Genesis torpedoes" and is preparing to attack, the Klingons are girding for action.

KLINGON HOME SYSTEM

This information is presented for gamemasters only. It is accurate and complete. Federation player characters are NOT to have access to it.

System Name: K'lai Klinzhai (Klinzhai's Star)

Number of Class M Present: 1 (originally 2)

LIFE AND CIVILIZATION LOG:

Code: 999983-76
 Dominant Race: Klingons
 Life Form: Mammalian

Technological Index

Space Sciences Index: 9
 Physical Sciences Index: 9
 Engineering Index: 9
 Planetary Sciences Index: 9
 Life/Medical Sciences Index: 8
 Psionics Index: 3

Sociopolitical Index

Social Science Index: 7
 Cultural Attitude Index: 6

World Name: Klinzhai
Position In System: 5
Number Of Satellites: 0
Planetary Gravity: 1.4g
Planetary Size
 Diameter: 18,200 km
 Equatorial Circumference: 56,000 km
 Total Surface Area: 714,000,000 sq km
 Percent Land Mass: 20%
 Total Land Area: 142,800,000 sq km
Planetary Conditions
 Length Of Day: 28 hours
 Atmospheric Density: Terrestrial
 General Climate: Tropical
Mineral Content
 Normal Metals: 31%
 Radioactives: 3%
 Gemstones: Trace
 Industrial Crystals: 5%
 Special Minerals: Trace

KLINZHAI

The planet Klinzhai is heavily cloud-covered, producing a 'greenhouse effect' that accounts for its tropical temperatures and high atmospheric humidity. Lush jungles, forests, and tropical grasslands cover its many islands and two major and one minor continents. Klinzhai has no real deserts, though some areas are simply too wild and desolate for Klingons to inhabit on a permanent basis.

Weather in the populated areas ranges from temperatures that would kill an unprotected Human, even with short exposure, to conditions that would be comfortable for most Terrans (but that Klingons find somewhat cold). Temperatures vary by little more than 15 percent each way, even between the 'hot' and 'cold' seasons. On Klinzhai, at

most latitudes, rain is a daily occurrence because of the atmosphere's extreme saturation (90-95 percent humidity). Only once in awhile is the sky clear enough to make the sun or the stars visible.

The main land mass of Klinzhai (known simply as "the continent") is now the seat of Klingon government, though the cradle of Klingon civilization is actually the Northern Islands (formerly the *komerex Nevre*) and the Crescent Islands. The mainland was settled by the Crescent Islanders only after the race already had a thriving maritime civilization.

MAJOR CITIES

The final unifying war on Klinzhai is commemorated by the preservation of the ruins of Khal City, the only place a nuclear device was ever detonated in war on the planet's surface. New Khal City is now the capital of Klinzhai and home of the Imperial Council. It is heavily fortified, and only five Humans have ever been here by invitation, including Dr. Emanuel Tagore, who was once a guest of the Empire as a Federation diplomatic envoy.

By tradition, however, the Emperor's home is in the city of Kahless, founded and named at the time of that Emperor. Kahless City is perhaps the best defended location in the Empire, better protected against ground assault than even the major planetary defense complex at Darbva. No non-Klingon except the most trusted *kuve* has ever been admitted to the Imperial Complex at Kahless City.

The city of Takta (meaning "Sentry") is the oldest city still standing on the mainland. It is a center of trade, has a major military base, and is the home of many skilled artisans. Klingon art being what it is, most is dedicated to themes of battle and glory.

"Southwatch" is the closest possible translation of the name of a city that has grown up around a major Klingon naval base. Once the most important sea-going naval base on the planet, it has declined in importance since the opening of the Northguard Naval Station in the Far Islands.

For security reasons, the only non-military spaceport on Klinzhai is located at Aval, a full continent away from the capital. The "foreign quarter" of Aval adjoins the spaceport. Orions and other races that move in and out of the Klinzhai system on trade or diplomatic business rarely are allowed to travel out of this quarter.

The Darbva Defense Complex is the nerve center of planetary defense operations, buried deep below the highest mountain range on Klinzhai, somewhere in the center of this desolate continent. *Darbva* means "underworld", in the sense of a place set apart for death and decay. It is high, cold, mostly ice-covered, and practically unapproachable except through heavily defended submarine channels and by space-to-surface transporter. The complex is linked to the many orbital defense stations around Klinzhai. Darbva is as near to impregnability as mortals can get.

The "New Continent" is a place of lush jungles and excellent farming. The line families that made the first landings here have mostly held on to their property, maintaining vast plantations worked by thousands of *kuve*. The only large city is *Distanda* ("First Landing"), the family seat of several distinguished Klingon lines.

THE SURFACE OF KLINZHAI

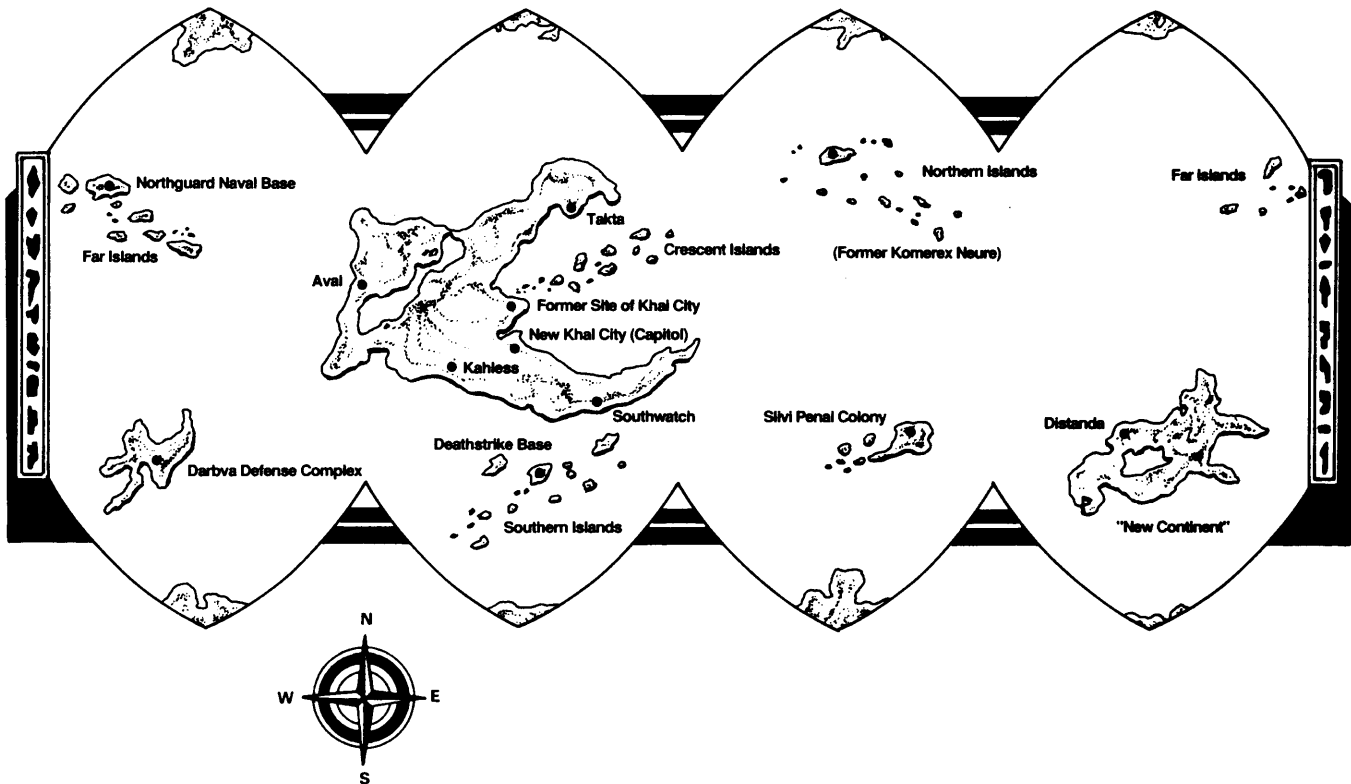

Slivi ("Hated One") is a penal colony worked only by non-Klingon prisoners and a very few of the worst Klingon criminals. The island is a deathtrap, inhabited by the most savage animal (and plant) species that Klinzhai has to offer. Only Slivi's rich uranium deposits make it worthwhile to maintain any permanent settlement in this place of death. It is said that being sentenced to the mines at Slivi is a life sentence, no matter how short the prison term. Indeed, very few prisoners have ever lived through their sentence and been released. Most have fallen victim to unsafe mining conditions, deadly plants and animals, and brutal Klingon guards (themselves prisoners of one sort or another, as no Klingon lives here voluntarily).

The vast Klingon oceans are dotted with small islands, and so fishing is the number-one occupation among low-status Klingons. Many islands are military reservations. One such, an unnamed jungle island in the Southern Islands, is the home of "Deathstrike", the fiercest guerrilla fighters in the Imperial Marines. This super-elite force of exactly 256 Klingons lives only for their training and for battle. Six are assigned to the Emperor's personal guard on a rotating basis. The others are ready, on a moment's notice, to mobilize from their private island spaceport to any trouble spot in the Central Empire. The cream of the Imperial Marines competes once a year for the privilege of being among the 750 Klingons dropped with gravbelts onto the island. In this little exercise, called "six days of death", the Deathstrike defend their island from intruders, who will outnumber them three to one. Casualties among the Deathstrike corps are filled from among the surviving attackers after six days of fighting. This is the only way Deathstrike members are recruited, and the only way they are "retired".

KOBEK

World Name:	KOBEK ('destroyed')
Position In System:	6 (now an asteroid belt)
Number Of Satellites:	1
Planetary Gravity:	0.7g
Planetary Size	
Diameter:	9,100 km
Equatorial Circumference:	28,000 km
Total Surface Area:	357,000,000 sq km
Percent Land Mass:	32%
Total Land Area:	114,240,000 sq km
Planetary Conditions	
Length Of Day:	26 hrs
Atmospheric Density:	Terrestrial
General Climate:	Warm Temperate
Mineral Content	
Normal Metals:	48%
Radioactives:	7%
Gemstones:	3%
Industrial Crystals:	Trace
Special Minerals:	Trace

INTERSTELLAR RELATIONS

UNITED FEDERATION OF PLANETS

Relations between the Klingon Empire and the Federation have been hostile from the start. Though the Klingons knew about the Federation's existence long before the UFP learned of theirs, first contact did not occur until Stardate 1/5105. On that date, a personal warp-driven Klingon shuttle made contact with the *USS Sentry* near Gamma Demetrius, and requested temporary political asylum for its passengers. When the Klingon warship *Devisor* demanded return of the shuttle and everyone in it, the *Sentry's* commander reluctantly honored the shuttle pilot's request for asylum. The Klingon and Federation vessels then exchanged fire briefly. Similar brief skirmishes and incidents continued to occur between Klingon vessels and individual Federation picket ships near the Klingon/UFP border, which was now under dispute.

The second major encounter occurred on Stardate 1/6003.04, when a Klingon starship, modified to transmit a Federation scout identification signal, seized the *USS Flying Fortress*, a slow but heavily armed prototype transport. In a sneak attack, the Klingons were able to destroy the transport's bridge, killing all command personnel and rendering the weapons systems inoperative. The ship also happened to be carrying the first experimental deflector shield, although the Klingons never did discover that fact. Even though the ship was temporarily in Klingon control, the arrival of a Federation anti-piracy task force soon obliged the Klingons to release their tractor beam. Though badly damaged, the *Flying Fortress* returned to Star Fleet's control, with all its secrets intact.

More than four decades passed from the time of the initial encounter between the Klingon *Devisor* and the *USS Sentry* and the start of the Four Years War. In that period, the Klingons knew of the Federation, a potentially hostile government, yet did not declare open warfare against the UFP.

Indeed, a war involving the Federation was postponed by a Klingon policy of aggressive expansion far from the Federation. In this period, Stardate 1/8203 to 1/8703, the Klingon Imperial Forces began a massive shipbuilding program and turned coreward, apparently seeking an easy but meaningful gain in territory there. Instead, they met the Kinshaya, and fought what the Klingons call the Demon War. Though the Empire managed to hold off this alien race, the Kinshaya eventually returned to plague them again. The major fighting has stopped, but both sides remain on alert. The Klingon scouts that have crossed the border have not returned, and so the Empire is not anxious to bait the fierce Kinshaya. Neither do they intend to turn their backs on this fierce warrior race.



THE FOUR YEARS WAR

For all practical purposes, the Klingons had been thwarted in their attempt at coreward expansion, and so turned their sights again toward the Federation. Believing the Federation to be a less formidable enemy, the Empire now launched a full-scale attack that they believed would result in a quick and inexpensive victory.

The Imperial High Council planned a bold offensive against the Federation. Having come under criticism for the abortive sneak attack against the *Flying Fortress* and again for the failure to rout the Kinshaya, the Emperor intended to silence his enemies by seizing and annexing a large region of space currently under Federation control. Having accomplished that, he intended to again turn the Empire's energies toward the Romulan Star Empire and the Triangle. Assuming that the Federation would relinquish control over the disputed area rather than enter a prolonged conflict, the Klingons expected the war to be over in a few months, with minimal casualties.

Though there was some concern among the High Command over the Empire's ability to wage a prolonged war, it was not deemed likely that war against the UFP would last more than two years. The Klingons believed that their massive ship construction program begun about five years prior would give them a quick victory through overwhelming fleet superiority.

Border skirmishes and incidents were commonplace, but the full force of Klingon aggression took the Federation by surprise, for they were unprepared both psychologically and militarily. Nevertheless, war was officially declared on Stardate 1/9409.29 when Klingon Admiral Kkorhetza refused to withdraw from Federation space.

The Klingons took an early lead. From Stardates 1/9410 through 1/9504, they won the decisive Battles of Andromeda, Genmarx, Lea, Lyclydun, and Janni IV. Though somewhat weak in tactical skill, the Klingons made up for it in numbers, often outnumbering Federation defending forces three or four to one.

From Stardates 1/9504 through 1/9507, the Klingons continued their inexorable penetration of Federation territory, dealing the UFP heavy losses, particularly in the Battle of GR-1 and the Assault of Nozseca VIII. Stardate 1/9507 marked the first significant Klingon defeat, with the Attack on Convoy Y-162 near the Rebonet system. In this battle, the Klingons did not have superior numbers, and it showed what the Federation's superior tactical ability could accomplish when the odds were more even.

Several months later, in Stardate 1/9511, the Klingons suffered their worst defeat yet, losing five squadrons to UFP forces in the Nostveg Engagement. This was followed by another stinging defeat in 1/9601, when the Klingons lost 30,000 highly skilled ground troops, including a crack Klingon Imperial guards battalion, in the Battle of Sinbad IV. It was one of the few confrontations between ground forces in the war.

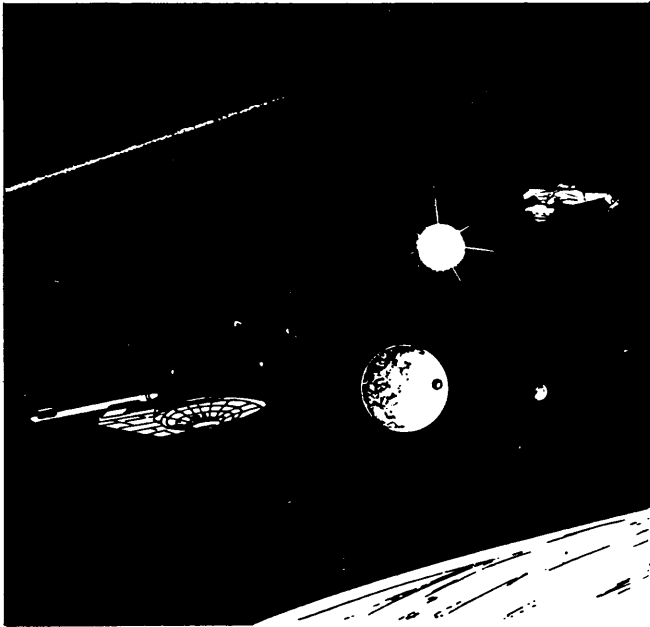

By Stardate 1/9602, the Imperial Navy had penetrated as deep as 15 parsecs into certain sectors of UFP space, but they were now seriously overextended. In 1/9608, the Klingons successfully used their new *D-10As* and *D-20As* against the UFP at the Debacle at Giso. Then, in Stardate 1/9608, they used chlortheragen in battle for the first time at the Battle of Rudgur III. A lethal nerve gas, the chemical inflicted great agony on its victims before killing them.

Though Klingon forces were still advancing as far as Thranstor on one front and toward Argelius on another, their logistical and morale problems had become grave. As Imperial forces pushed deeper into Federation space, their lines of supply grew longer and more tenuous. Both the Battles of Argelius and Thranstor ended up as harrowing defeats for a Klingon force that now lacked supplies, reinforcements, and organization.

From Stardates 1/9703 to 1/9711, the Federation won most of the twelve major fleet actions that took place. The tide of war had shifted in their favor, and numerous Klingon task forces were now in retreat. It was at this time that Klingon Admiral Komex surrendered and gave the Federation information leading to the Klingons' final defeat at Kolman, their main center of operations. As Admiral Komex had predicted, the Klingons did sue for peace after this battle.

The Treaty of Axanar was signed on Stardate 1/9806.13, and opened up new areas of space for the Federation. Though defeated, the Klingons had also made territorial gains during the war. They built a new star fortress at Mastocal and continued to consolidate their gains. As a result of the war, the gap between the Klingon and UFP borders had shrunk, which made future conflicts even more likely.

The Four Years War utterly transformed the Empire's thinking about the Federation. Though UFP forces had driven out the Klingon invaders, they had also chosen not to penetrate the Empire. Klingons reasoned that if a contemptible race chose not to destroy them, it could only be because that race held Klingons in such low esteem that they could accrue no honor in doing so. By neglecting to deliver a crushing defeat to the Klingons, the Federation had instead given them an unforgivable insult. The Empire would have its revenge.

THE ORGANIAN CONFLICT

It was only a matter of time before Klingon/UFP hostilities heated up to again create a major crisis. This series of border battles, skirmishes, and the Klingon seizure of the planet Organia is now known as the Organian Conflict. Paranoid over the number of Federation colonists poised on the edge of their territory, the Klingons launched their fleets toward the UFP. As both sides jockeyed for position, the planet Organia, populated by simple farmers and peasants, gained importance as a strategic location for a base of operations. When Klingon and Federation forces clashed for control of Organia, the Organians suddenly revealed themselves as beings of advanced mental power who had nothing to fear from the Klingons or the Federation, but who had a fundamental dislike of war. Backed up by their psionic abilities, they imposed a unilateral cease-fire and peace treaty.

The Organians are total pacifists, a concept frustrating to the UFP but almost intolerable to the Klingons. Unfortunately for the war parties on both sides, the Organians had the power to back up their demands for peace. They imposed a peace treaty forbidding armed hostilities in a protected area along the UFP/Empire border near Organia. The Organians threatened to immediately disarm both sides if armed conflict occurred in the Zone. (Indeed, violators of the treaty found that their weapons simply refused to work in the Treaty Zone.)

Organian mental might protected planets in the area, and ensured that inhabited worlds would remain off-limits to either the Federation or the Empire until the planet's population was ready to choose how to enter galactic society. Class M worlds were to be developed under the guidance of the side judged able to do so most efficiently. Forces of both sides must extend certain courtesies to their opposite numbers at bases in the area, including shore leave rights, medical attention, and so on. Unable to circumvent Organian intervention in any significant way, the Empire had to learn more subtle methods of gaining a toehold in this area of space.

The prohibition against conflict did *not* prohibit ships of either side from crossing over into the other, nor did it seem to prohibit armed conflict (even ship-to-ship battles) at any distance from Organia. Since the imposition of the Treaty, both sides have been sending forces of various sizes across the Neutral Zone, testing to see what size force could cross and still be able to use their armaments. The consensus was that a single ship, operating alone, could use its weapons freely, which explains the sudden increase in the size of Klingon battleships.

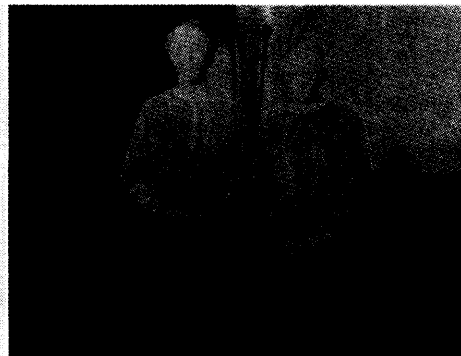

In recent years, however, the Organians have apparently ceased to police the zone. Neither side knows why or if the Organians might change their mind at any moment, but they both have taken advantage of the situation. The prospect of war hovers once more over the two superpowers.

Beyond the Orion systems lies a small area of space where the Empire and UFP meet, which is not covered by the Organian agreements. During the early years of Klingon/Federation relations (up through the time of the *STAR TREK* TV series), little conflict occurred here because there seemed to be nothing worth exploiting in the area. In later years (between the TV series and the time of the first *STAR TREK* motion picture), the strategic location of this area near the Triangle would become important. It is the only remaining section of the old "Klingon Neutral Zone", the rest having been absorbed by the Organian Treaty area. Any ship crossing this zone into the other's territory is fair game for attack and destruction, and the Klingon Empire jealously guards the border, patrolling with squadrons of its best ships.

Relations with the UFP have not necessarily worsened over the years, but they have shifted somewhat. As the Imperial Race Klingons have consolidated more and more power, displacing the Klingon/Human Fusions in the border areas, contacts with the UFP (by the time of *STAR TREK II: The Wrath of Khan*) have become more and more tense. The Subaiesh line, which favors peace with the Federation, has lost most of its influence to the Reshtarc line, who are pure Imperials and who wish to force confrontation with the UFP.

At the moment, the Klingons who infiltrate Federation space are bent less on outright destruction or even surprise attacks than on subterfuge, intelligence gathering, contacting malcontent groups, and other such missions. They seem to be attempting to learn more about Federation technology and to come to some sort of Klingon understanding of the people and politics of the Federation. Many Klingon ships sneak in through Orion free space, and appear 20 parsecs behind the UFP forces that are watching for them.

[NOTE: That these raids may have the tacit approval of the Emperor was shown by the Genesis Incident, in which Captain Kruge stole the Federation's supersecret Project Genesis data. Though Kruge died in the attempt, Imperial Security Officer Karamark vestai-Treth secretly transmitted a copy of the Genesis data to his superiors on Klinzhai. Someone deep within the ranks of Star Fleet was the key to Kruge's ability to obtain information on Genesis in the first place, which shows how profoundly the Klingon spy network has extended into Star Fleet Command.]



ROMULAN STAR EMPIRE

Contact with the Romulans goes back much farther than the Empire's dealings with the UFP. To Klingon eyes, the Romulans are definitely *komerex*. Though that makes them dangerous, it also makes the Romulans seem more comprehensible and predictable.

Most of the conflict between the Romulans and the Klingons occurred because of disputes over the area of space that lies between them. With so many desirable planets in the region, neither side was willing to cede it to the other without a fight. The resulting conflicts drained the resources of both sides. The Romulans, however, suffered from a technological deficiency in warp engine design and ship construction facilities, which counterbalanced their greater command of space combat tactics and strategy.

The first Klingon/Romulan contact occurred on Stardate 0/0001.30, when three larger Klingon vessels attacked a Romulan scout ship near the Romulan colony of Delta Khinah II. Finding himself in a no-win situation, the Romulan Commander self-destructed his ship, but not before a message pod containing his log tapes and visual communications with the Klingons was dispatched to the Romulan base.

Though the Klingons were engaged in several other conflicts within and around their borders, they went to war with the Romulans in a conflict that lasted more than three years. In the midst of this costly, fruitless battle, the Romulans tested their newly developed cloaking device with an attempted penetration of Federation space ("Balance of Terror"). When the attempt failed, the Romulans realized that they needed both a technology boost and an end to the drain on their resources that the Klingon conflict was causing. Also ready to call it quits, the Klingons agreed to negotiate a treaty (in their favor, of course). The Romulans conceded several small bases, along with mineral rights to a large asteroid belt.

The Klingons and Romulans continued fighting informally for many years, neither side pushing for an escalation. Though both sides denied the attacks, each carried out many small raids against the other, usually with not more than three or four attacking ships. Both sides made extensive use of privateers and often used armed merchant vessels as decoys. This seesaw activity continued for over 100 years. Much of the fighting centered in the area that came to be known as the Triangle, the region where the Klingon, Romulan, and UFP areas of influence collide.



EXCHANGE AGREEMENTS

The petty bickering ended with the signing of the first of three non-aggression and technological exchange treaties on Stardate 2/0902. The galactic ramifications of these treaties have been immense, because they have allowed both sides to concentrate their main effort against the UFP, whom the Klingons attempt to portray as a common enemy. In reality, the Empire simply wanted to buy some time. The Klingons believed that if they and the Romulans jointly defeated the UFP, then the Imperial forces could eventually overwhelm the exhausted and depleted Romulan forces, especially if the Klingons held back and allowed the Romulans to do most of the fighting. The Romulans, of course, intended the same thing.

First Klingon-Romulan Treaty

As a plum to bring the Klingons to terms, the Romulans gave up claim to most of the contested areas, particularly in the Triangle. Both sides also provided the other with items of technology that were supposed to strengthen their position against the UFP. If nothing else, each side also gained valuable time to recoup losses and assess the future.

The Romulans furnished the Klingons with cloaking devices, older-model versions that the Romulans had equipped with a fail-safe device that permitted only Romulans to operate them. (The device would self-destruct if anyone else tried to open it up to learn its secrets. Indeed, the Klingons lost several ships in just this way shortly after obtaining the device. The Federation, too, lost a ship that it tried to equip with a captured cloaking device, as portrayed in "The *Enterprise* Incident".)

To this day, the Klingons have not learned to construct a cloaking device or how to disarm one. At one point, they managed to capture one of the few Romulan cloaking device technicians, but even the infamous Klingon interrogation methods could not pry the secret from him. The Romulans later provided the Klingons with cloaking devices that could be installed on smaller ships, which allowed the small Klingon spy ships to penetrate deep into UFP space. The Romulans did teach the Klingons to operate and service the devices, however.

[NOTE: Klingon commanders do not particularly desire ships equipped with the cloaking device. They would rather go into battle at full tilt, with shields activated, weapons armed, and speed up. Because the cloaking device requires so much power to operate, an activated device slows down a vessel considerably. To date, the Klingons have obtained only about 100 of the devices.]

The Romulans also gave the Klingons their plasma weapon, whose technology the Klingons had coveted but been unable to duplicate. Knowledge of the plasma beam eventually led to the development of the Klingon version of the photon torpedo, which makes the new, uprated *D-7* battlecruisers such a threat. The discovery came purely by accident, however. When some Klingon scientists were trying to take apart a plasma weapon, it exploded instead. Another team of scientists subsequently arrived at the station to study the cause of the explosion, and they inadvertently discovered photon technology. Through a series of controlled experiments, the Klingons soon developed the photon torpedo.

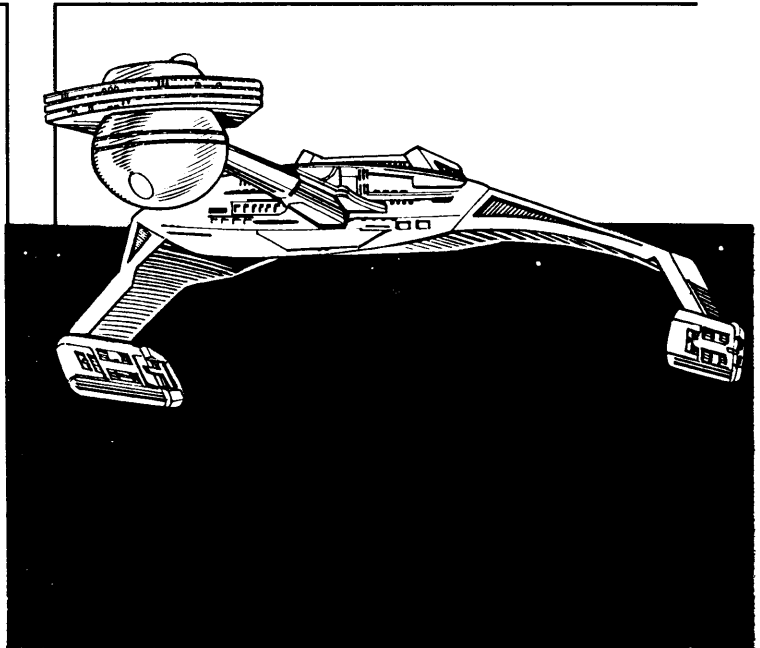

The Romulans gained ships from the accords. Most important was the Klingon *D-7* Class battlecruiser, though they also received ore carriers, repair vessels, and a few scouts. The Klingons gave them an older model *D-7*, which carried an earlier version of the disruptor. This was much-needed technology for the Romulans, who were able to adapt and modify it until their own versions became their main weaponry. The Romulans also gained hand disruptors, which rapidly became the personal weapon of choice.

Second Klingon-Romulan Treaty

With this treaty, signed on Stardate 2/1109.13, no technology of importance was exchanged. The main Romulan concession was to give the Klingons a much desired base in the Triangle, a base that the Romulans felt they were about to lose anyway. In return, the Klingons gave up several bases coreward of the Triangle.

Third Klingon-Romulan Treaty

This treaty, signed on Stardate 2/1801.18, gave the Klingons several Romulan *S-11* Class scouts. Re-equipped with Klingon shipboard systems, this became the *K-22A Bird of Prey* Class Scout. The Romulans, in turn, received much-needed mining equipment of a type they had been unable to develop.

CURRENT STATE OF AFFAIRS

The Klingon-Romulan alliance is shakier today than it has been in many years. The Klingons have become more aggressive, openly attacking Romulan outposts, probing for weak spots and testing defenses for readiness and strength. Klingon diplomatic messages have had little real diplomacy in them, conveying lightly veiled threats instead. The Klingons are readying for a major offensive, although it is doubtful if they could achieve real superiority in more than a small sector.

The Romulans, on the other hand, have taken a defensive posture. They are biding their time, hoping for a major UFP-Klingon conflict. They are more concerned with expansion coreward, but they are unwilling to give up any more of their territory.

ORION COLONIES

The UFP/Klingon border skirts along the neutral systems of the Orions, near Rigel. Though the Orions are comparatively weak, the Empire respects their neutrality, and even extends to them favored status in trade and travel permits within the Empire. This practice is logical and typically Klingon in its craftiness. The 'neutral' Orions practice piracy and are more of a thorn in the side of the UFP as independents than as a conquered or subjugated part of the Empire. Indeed, the Orion planets provide a safe haven for Klingon agents and a fertile breeding ground for turncoats and double agents. Though there is no evidence linking the large corporate houses of the Rigellian worlds, it is clear that both sides have been helping each other for years.

One reason that the UFP has not taken more concrete action against Orion piracy is that armed action so near the Empire's border could easily invite Klingon intervention and escalate to full-scale interstellar war. Though no Klingon commander or leader would admit it, the Empire allows the Orion systems to continue their independence for the same reasons. Meanwhile, the Orions enjoy their unique position, and whenever possible, play the two sides against each other for their own benefit.

All this may now be coming to an end. For the first time in many years, Klingon sentiment is swinging against continued affiliation with the Orion merchant guilds. The Drexa, a Klingon/Human Fusion line, seem to be leading this movement. It is not clear whether the Drexa advocate complete separation from the Orions or whether they are simply alarmed by a growing Orion presence on planets within the Klingon sphere of influence. The Klingon Empire is also apparently displeased about increased Orion activities within the Triangle Zone, despite the fact that Klingons and Orions have occasionally acted together in defiance of Federation interests.



IMPERIAL KLINGON STATES

In recent years, the Imperial Klingon States have gained influence among the independent worlds within the Triangle Zone. The Klingon Empire previously denied the existence of these renegades, but later denounced them as traitors, fair game for any Commander wanting to make a name for himself. Recently, however, the existence of these dissident Klingons has become more than just an embarrassment to the *komerex*. The renegade power base has grown at the expense of their parent empire, and at the Emperor's expense, in particular. The IKS has successfully blunted Klingon expansion within the Triangle. IKS agents are presently waging a propaganda campaign aimed at discrediting the harsh totalitarian rule of the present regime in favor of the presumably more flexible and democratic alliance of family members in the IKS.

Tales of freedom of action, rapid promotion, and lucrative plunder have motivated many talented Klingon officers to join the IKS. By setting themselves up as a rival *komerex*, the IKS is inviting the Empire to retaliate. So far, the Empire has taken no direct military action, probably because they do not want to give the UFP an excuse to enter the Triangle in force under the guise of 'peace-keepers'. Intelligence sources suggest that several houses are considering forming special hunter-killer squadrons with the sole mission of destroying IKS men and materiel. Among those house lines, the Juriss have apparently committed themselves wholeheartedly to the idea. They are reported ready to pledge their entire line holdings to eliminate the traitors as soon as the Emperor grants permission.

The fact that these actions originate from lines dominated by Klingon/Human Fusions may indicate the considerable power still held by these houses. Despite efforts to reestablish their dominance, the Imperial Klingons may be forced to form an alliance with the Klingon/Human Fusion lines. The Fusion lines will no doubt extract a high price for their assistance, if it is required.

GORN ALLIANCE AND THOLIAN ASSEMBLY

Though the Klingons know about the Gorn and the Tholians from their spies within the UFP, they have not directly encountered or made agreements with either race. Moreover, it is highly unlikely that contact would result in any form of cooperation. The Gorn are too gruff and expansionistic and the Tholians too totally alien to relate to the Klingons as anything but enemies. The Empire, however, has a vested interest in seeing that no other group, especially the Federation, makes any lasting military alliance with either group. Thus, the Empire is not above a little clandestine intervention in this regard.

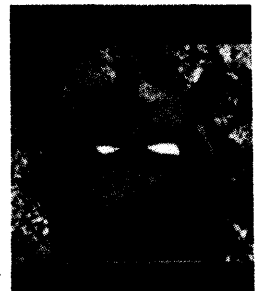

KINSHAYA

The mysterious race known as the Kinshaya are the only spacefaring culture ever to dare to invade the Klingon Empire. The war the Klingons once fought against the enemy they call the "demon-possessed" was one of the bloodiest in their history. Despite this, the Klingons still know precious little about this implacable enemy—not even the location of their home planet.

During the Demon War (Stardate 1/8203 to 1/8703), the Imperial Fleet faced the black globe ships of the Kinshaya again and again, but never captured one intact. By sifting through the wreckage of Kinshaya vessels and studying the remains of the single Kinshaya ever captured, Klingon scientists have managed to learn something about them.

The Kinshaya are nightmarish beings, even by Klingon standards. The average warrior is covered with short, greenish-black fur, stands over two meters in height, and outweighs two Klingon soldiers. Kinshaya have no discernible head, except for a bony swelling atop their shoulders. Their 'faces' consist of two twin-lensed sight organs between the shoulders in front, a flap-covered breathing orifice, and a round mouth ringed with three rows of sharp teeth.

There is a rudimentary sight organ in back, capable of discerning moving objects without much resolution or color vision. Their organs of hearing are completely covered by skin, and seem to be vibration sensors more than anything else, though they do communicate by a spoken language. The Kinshaya stand upright, with two arms and legs, but their legs are covered with sharp-edged plates of horn, and loose folds of skin that resemble dark wings hang from their massive arms. They are of two sexes. Both sexes fight in combat, but show no immediately obvious physical differences. To a Human, Kinshaya would most resemble huge bats. To a Klingon, they resemble demons of their ancient legends.

Kinshaya seem to wear no clothing or armor, except utility belts and straps from which hang their hand weapons. They are fond of blaster-type hand weapons (similar to those used by the Gorn) and bladed gauntlets that strike as large daggers (some with three or four blades).



Despite their brutish appearance, the Kinshaya are serviceable technologists. The warp drive ships they used in the Demon War appeared as black globes, with their matter-antimatter drives completely enclosed in the hull. (Kinshaya are far less radiation-sensitive than Humans or Klingons.) Their weaponry at the time consisted of lasers and a modified plasma bolt, similar to that of the Romulans, but the power levels were far superior to that of the Klingon Empire's ships. Their targeting capability, however, was not as sophisticated. Shielding on the Kinshaya vessels was roughly equal to that of the Klingons.

The Kinshaya seem not to comprehend the notions of negotiation, diplomacy, making demands, or even acceptance of abject defeat. They simply destroy whatever non-Kinshaya intelligent life they encounter. The Kinshaya attack without warning or challenge, and will fight until one side or the other is destroyed, or their prey has fled. They do not seem to understand the concept of strategic withdrawal, and it was this trait that eventually gave the Klingons a chance during the Demon War. Even the Empire understood the usefulness of hit-and-run tactics, but the Kinshaya did not.

They are carnivores, and do not seem particular about the nature of animal matter they consume. The presence aboard some destroyed Kinshaya vessels of members of a small mammalian servitor race the Klingons later encountered in the Rift led Klingon scientists to believe (correctly) that the Kinshaya domesticated other animal lifeforms (intelligent or not) for food.

When the major fighting had ceased, it broke down into scattered warfare. Neither side wants to force the issue at the moment, which may mean the Kinshaya have been learning something about strategy.

A state of prolonged but stalemated war exists between the Klingons and their coreward neighbors. As a result, the Klingons have built new star fortresses such as Kodal as well as adding Oran to the existing production facilities in the region. The conflict with the Kinshaya is enough of a drain on Klingon men and material that it takes some pressure off the Federation. For the time being, the balance of power between the Kinshaya and the Klingons does not seem likely to change. Both sides seem content simply to protect their positions. To this day, the Klingons do not know the location of even one intact Kinshaya colony world, much less where their homeworld might be.

Name: KINSHAYA WARRIOR

Attributes:

Generate statistics by rolling 3D10 + 40 for all attributes except LUC and PSI, and 1D100 for LUC and PSI. Apply the following racial modifiers.

STR	+40	CHA	-20
END	+20	LUC	-25
INT	—	PSI	-40
DEX	-10		

Kinshaya are never played as player characters, so they do not receive bonus points. The average Kinshaya warrior thus has the following statistics:

STR	95	LUC	25
END	75	PSI	10
INT	55	INACT SAVE	20
DEX	45	UNC THRESH	5
CHA	35		

THE KLINGON PEOPLE

As everyone knows by now, there are three types of Klingons: Imperials, Romulan Fusions, and Human Fusions. Human Fusions are the type familiar from the *STAR TREK* TV series. Imperial Klingons, the purebloods, were first seen in the *STAR TREK* motion pictures.

The physical differences between Imperials and the two known sub-races show up in their game statistics. When creating characters, players must note the different racial modifiers to attributes for each race. (See **Creating Klingon Player Characters** in this book.) It is ironic that Imperial Race Klingons have shorter lifespans than do Fusion races. (Imperial Race Klingons reach the critical age when faculties begin to fail at about age 40. Human Fusions reach it at age 45, and Romulan Fusions not until age 60.)

All Klingons take a bit more damage from puncture wounds and cuts than do Humans because they have so many blood vessels so near the surface. (This gives them increased surface blood flow to help cool their bodies in the hot, moist climate of their Klinzhai homeworld.) They are also more susceptible to neural drugs such as stimulants and sedatives. Imperial Race Klingons suffer slightly more than Fusions in this regard. These differences are discussed at length later in this book, in the section on **Injury, Death and Medical Aid**.

Klingons are less affected by agonizers and phaser stun than are other races. This benefits Fusions less than Imperial Race Klingons, however. See **Injury, Death and Medical Aid** for more detail.

GENETIC ENGINEERING

The Klingon Empire has invested great effort and resources in experiments in genetic tailoring, though it was never with the motive of creating a better Klingon. The Fusion races were and are intended as useful members of society, but they are by no means considered to be improvements on the original design.

Why, with all their knowledge, does the Empire not breed a race of invincible super soldiers, with strength, stamina, and senses enhanced to the limit? (Earth science did this once, using selective breeding techniques during the Eugenics Wars.) Using the gene-splicing techniques that produced the Klingon Fusion races, the creation of a super Imperial would be quite possible, but it is unlikely that the Klingons will ever seriously pursue the idea.

Klingons understand power as does no other race in the galaxy. They grow up learning to play the game of *komerex zha*, the Great Game of Empire. A Klingon knows instinctively that to create a being greater than oneself invites that other being to usurp control over all one has. The Klingons do not wish to be the creators of the race that will—that *must*—replace them.

Nor is it likely that they will produce more Fusion races in the future. With power now more firmly seated in the hands of the Imperial Race, the Imperials are reexamining the wisdom of creating the Fusions in the first place. Those in power do not wish to reinforce the Human and Romulan Fusions, however useful they may be in dealing with other beings of unpredictable non-Klingon traits.

It is for this reason that most recent genetics research in the Klingon Empire has aimed at producing lower forms of life that have some military use. The most promising such discoveries have been in creating disease organisms for biological warfare. For safety and security, Klingon scientists carry out such research on isolated worlds far from Klinzhai, using servitor races as staff, and prisoners as occasional guinea pigs. The most significant example of this occurred on D'Korman III in Romulan space, near the Triangle. The Klingons released a DNA organism on that world, which resulted in the death of 99.999 percent of all life on the planet. To this day, D'Korman III is quarantined by the Romulans.

IMPERIAL KLINGONS

Imperial Race Klingons are the original native race of the planet Klinzhai, and they are most numerous within the central Klingon Empire. The current Emperor, his line, and his household are Imperial Race Klingons, and most of the political power in the Empire is currently held by members of this Klingon root race. The information published in the *ST:RPG2 Cadet's Orientation Manual* accurately describes the physical appearance of Imperial Race Klingons. Note that Imperial Klingons would almost *never* be able to pass themselves off as Human, even with makeup.

Imperial Race Klingons tend to be more short-tempered, more impulsive, more warlike, and less patient than members of Fusion races. They are more susceptible to cold and dry conditions than Fusion race Klingons. They do not interact well as equals with anyone except other Klingons, though they are not any more intolerant of servitors who have outlived their usefulness than any other Klingon. They rely less on subtlety and more on force. Imperial Race lines tend to be older, more conservative, and less likely to accept change than Fusion lines.

FUSION RACES

The Klingon/Human Fusion race was originally created to give the Empire soldiers and military leaders who could live and fight comfortably on Human planets, and who could better understand and predict the actions of Human military leaders. These are the Klingons portrayed in the *STAR TREK* TV series. The experiment worked well, and Klingon/Human Fusions do indeed function better than Imperial Race Klingons in situations involving Humans.

The same is true for Klingon/Romulan Fusions on the hotter, less humid worlds favored by Romulans, and in dealings with Romulans. It was Klingon/Romulan Fusions who formulated the strategy against the Romulans in many skirmishes between the two governments, and it was members of this same Klingon sub-race that drafted and prepared the various Klingon/Romulan technological exchange treaties. (It was Imperial Race Klingons who presented and negotiated these treaties, however, with the Fusions as advisors at a distance. The Romulans would never have negotiated with genetic mockeries of themselves. Though they are quite aware of the existence of the Fusions, they do not like them.)

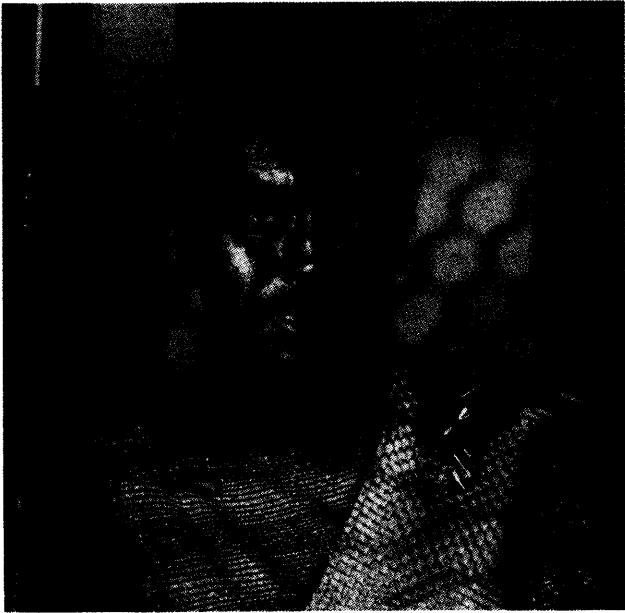

During the period of Fusion-race dominance on the Empire's borders, Klingon military policy grew less overtly warlike. Expansion was accomplished more through subtle manipulation of power than with fleets of ships. These Klingon Fusions were no less ambitious, but they pursued their goals in more devious ways. At the time of the *STAR TREK* TV series, Klingon/Human Fusions were in charge along the Klingon/UFP borders. Fusions were initially created to help push back the frontiers of the Empire, and so they were most often involved in the highly lucrative exploitation of new planets. Their lines grew more numerous and more powerful, which the Imperial line families did not like at all.

This changed not long before the end of the *USS Enterprise's* five-year mission under Captain James Kirk. Imperial Race Klingons began reasserting their authority and taking a more active part in the government and control of the border reaches. The change has been a subtle, slow one, for neither the Imperials nor the Human Fusions were willing to risk civil war. At the present time, the Imperial Race Klingons have managed to regain much of their property and power. By the time of the *STAR TREK* movies, Imperials are more in evidence, and the influence of the Fusion races is declining.

With this change, Imperial policy in dealing with aliens has begun to revert to a more war-ready posture. Tensions have heated up along the Organian Treaty Zone as well as in the Neutral Zone, and a major military buildup has begun. Because of this, the Emperor and the Council are more likely to sanction adventurous and somewhat simplistic solutions to problems (such as Kruge's one-ship raid deep into UFP space in search of the Genesis Device in *STAR TREK III: The Search for Spock*).

Gamemasters can make use of the changing nature of Imperial policy to create scenarios and plots for either UFP or Klingon player characters. Remember that members of different sub-races rarely serve together on one ship, and that ships crewed by Fusion races are likely to answer to superiors of that same Fusion race, except at the highest levels.

THE KLINGON PERSONALITY

Though the dominant Klingon personality trait is the desire for personal status, their culture does not see this as simplistic or selfish any more than Humans consider the desire to succeed at one's life-goals to be selfish or naive. Advancing his personal status is the best way (if not the *only* way) for a Klingon to advance the status of his line and of the Empire as a whole. Because every Klingon learns, from early childhood on, that it is his destiny to lead, it is as natural for him to seek glory and personal power as it is for Humans to breathe.

A corollary of this drive for status is an ingrained, almost racial disdain for self-sacrifice. That is not to say that Klingons never sacrifice personal comfort or safety for a common goal! Indeed, when there is the possibility of increased status for Empire or line, a Klingon will do anything he must. Indeed, if dying is the only way a Klingon can gain status, then he will accept death before dishonor. If he can find a way to make someone *else* die instead and still gain the same end, however, he finds no shame in that.

This focus on personal power is contrary to the values of most Human cultures, which usually stress the attainment of the group goal first. ("Do unto others as you would have them do unto you", or, "The right to swing your arm ends where the other person's nose begins".) The Klingon believes, however, that he serves the group goal best by gathering and concentrating personal influence and power. The more influence an individual has, the more that influence carries over to his associates, his line, and to the entire Empire. If the individual's use of his power is not in the interests of Klingon society, however, only someone with even *more* power can come in to oppose him.

Where Romulans are devoted to duty, Klingons are devoted to dominance. They believe that only those strong enough to hold onto life are 'entitled' to it. (Klingons are excellent observers of natural ecology, but terrible practitioners of ecological conservation.) Races that were meant to serve (the vast majority of life in the universe) are *kuve*, intended to serve. Those races born to dominate (like the Klingons themselves) must continue to expand and conquer endlessly. For the Klingons, there is no such thing as stability. If there is no growth and increase, then there is death.

Because every Klingon expects every other Klingon to seek personal advantage at all times, Klingon relationships are based on degrees of mutual distrust. The only people Klingons trust are those whose goals complement their own. As advancement of one's line is a common goal that lends itself to cooperative effort, line relationships are strong ones. Relationships among members of a ship's crew are often strong also, as long as a crewmember stands to gain more from his captain's continued success (which reflects on his crew) than on his officer's downfall. The life of a Klingon is one of creative, reasoned, and quite justified paranoia. The careful Klingon spreads the glory of his accomplishments around among his intimates, ensuring their loyalty and insulating himself from those who would do him harm. Keep this in mind when playing Klingon NPCs, and remind Klingon player characters of this if they become too devoted to a 'me first' attitude.

Though often described as cruel, Klingons are no more so than Humans. They only seem more cruel because their society not only permits but encourages taking advantage of every opportunity to gain the upper hand. A Klingon will use torture freely to get what he wants, because that is the most important task in his life. Once he had obtained what he wanted, a Klingon would have no motive to continue torture for its own sake. The fact that Klingons are cruel only for a reason is of little comfort to the victim, however.

Just as with Humans and most other races, some Klingons are impulsive and quick to anger, and others are calculating and cool. Some are patient and some are not, depending on what their personal experience has emphasized. Klingons also have as much emotional range as Humans, and do express it as freely. Give Klingon NPCs some room to show their individuality, and encourage it in Klingon player characters. After all, what's the use of having a colorful and interesting alien race if all members of that race are going to be roleplayed exactly the same way?

Klingons are not creatures of tradition. They keep the practices and customs that are useful and throw out those that are not. Line traditions and Imperial traditions endure, not because of sentimental attachment, but because they work well. A Klingon is the ultimate pragmatist and has little respect for anything that does not improve his status. Even Klingon play is goal-directed, from earliest childhood on. Klingon art is judged by its ability to inspire one to greater feats of accomplishment. Klingon music all sounds like military marches. Klingon sports are oriented toward the development of combat skills. Klingon drama is always inspirational. Klingon comedy consists of one individual succeeding while others fail in surprising or amusing ways.

To a Klingon, life is and should be a constant struggle for dominance. According to their legends, the struggle continues even after death, with the shades of old heroes sailing in the Black Fleet. A Klingon cannot "settle for less" or "rest on his laurels". It is alien to his nature. He is happy only when climbing the ladder, and he will not stop climbing, ever.

PSIONICS

Official Klingon policy forbids using races with psychic abilities as servitors, nor does it allow any experimentation in this field, either with servitor or Klingon subjects. This is for the same reason that the ruling group does not wish to breed a super-Klingon. Psychic abilities could be a dangerous weapon, and Klingons are much too paranoid to allow into their society anyone with the power to read minds or influence thoughts. So much of Klingon life depends on secrets within secrets. They do not trust anyone who 'knows too much' (which also accounts for Klingon distrust of the psychically gifted Vulcans).



The current Imperial government actively seeks to suppress the development and use of psychic powers. An Imperial decree can instantly put to death a proven psychic among servitors, and even a Klingon of influential family would have a hard time avoiding a death sentence if detected as a psychic.

Of course, psychic abilities are much rarer in Klingons than in Vulcans or even Humans. Still, it has been known, even in the recent past. Though the current government suspects the existence of a psychically gifted Klingon underground, this is not true. But *some* psychically gifted Klingons exist. Gamemasters should NOT allow any Klingon player character to have such abilities, but the introduction of a psychic as an NPC could lead to some interesting adventures.

KLINGON PARANOIA

As with genetics and psionics, the Klingon government will investigate any development in scientific knowledge that might give one group of Klingons any political or military advantage over others. Klingons trust no one, *especially* not other Klingons! The Imperial government, therefore, tightly controls all scientific research.

This means, of course, that every major line family has its own secret research efforts going on anyway! (After all, no one wants the Imperial Household to have too much power, either!) For this reason, one line may create and control many developments in weapons research and battlefield medicine for a time, until spies from rival lines reveal the secret and make use of it themselves. This is all part of the *komerex zha*, and maintains the balance of power in the Empire.

The existence of such covert scientific operations offers the crafty gamemaster many adventure possibilities. It gives a perfect excuse to adjust the weapons capability of Klingon ships that UFP player characters encounter, for example. No purely speculative weapons should be rung in on players (unless it is part of a scenario where the characters have a fair chance to figure out what is happening and to counter the weapon), and out-and-out arms races are greatly discouraged. It is quite permissible, however, to put a slightly more powerful weapon aboard a known ship type, or to equip a Klingon landing party with a different sort of hand weapon. It does tend to liven up things for player groups that are becoming complacent!

A secret scientific project can also be the center of an adventure for either UFP characters (who must sabotage the experiment or gain information about it) or other Klingons (who have the same options, plus the possibility of stealing the new scientific breakthrough for their own use). Remember to keep such devices from being too powerful, especially if there is a chance that player characters will get their hands on them. To maintain play balance, any really *big* breakthrough should have a fatal flaw. (The new long-range transporter will not work on living organisms; the new nerve gas requires a rare chemical the players can run out of; the deflector shield belt shorts out when the air is too humid, and so on.)

Remember that Klingon paranoia works against anything that endangers the status quo. Do not allow Klingon player characters to get too powerful without giving them some powerful NPC enemies to contend with among their own people. Federation player characters, on the other hand, may be able to use this paranoia to advantage in some situations if they can convince one set of Klingons that *another* set is plotting against them.

RELIGION, MYTH, AND LEGEND

Klingons do not believe in gods, at least not as higher beings to be worshipped. Indeed, the race admits to the existence of no higher beings than themselves. (Encounters with races such as the Organians have shaken this certainty somewhat.) As a general rule, Klingons will rationalize such situations away, or pretend they do not exist. Faced with truly godlike powers, Klingons are much more disoriented and upset than are Humans, and will likely respond with irrational hostility or outright disbelief. (It makes one wonder what would happen if a Klingon ship tried to penetrate the energy barrier surrounding the universe. What would the Klingons do about a Klingon version of Gary Mitchell from the episode "Where No Man Has Gone Before"?)

Klingons do curse, but usually they invoke the names of legendary heroes or powerful animals. The exclamation "Kahless' Hand" (*kahlesste Kaase*) refers to the fact that Kahless bound his hand to his control chair to dramatize his determination not to abandon his command in his final battle. Similarly, "Kagga's crown" refers to the Klingon whose crown was branded upon his forehead when he served as Emperor for one hour while under sentence of death.

The Klingons have legends and practices, however, that have grown to be almost as important as religious beliefs. The most prominent among these is the belief that the Naked Stars (seen so infrequently on cloud-shrouded Klinzhai) ensure the remembrance of any event they witness. No modern Klingon is likely to openly put much faith in this sort of thing, but it will affect his behavior nonetheless. A starlit night is a good time to expect a Klingon sneak attack.

The Black Fleet is another widespread Klingon legend among the military. According to this tale, warriors who die are assigned to the Black Fleet, where they continue to amass glory and honor in endless combat against worthy foes who have also crossed over into death. This is not truly a belief in a literal afterlife; the Black Fleet is more symbolic of how glory endures beyond the physical death of an individual. Klingons do not reserve assignment to the Black Fleet to Klingons alone. Servitors who are loyal to their masters will be rewarded upon their deaths with the chance to honorably continue their service with the Black Fleet. Likewise, a Klingon does great honor to an enemy when he expresses the wish to meet that enemy again in battle after they have both passed on. ("Perhaps we shall do battle again when we both join the Black Fleet!")

Gamemasters are encouraged to make their Klingon NPCs come alive by spicing their characters' speech and actions with some of the rich background of Klingon history and lore. When they talk, threaten, gloat, or negotiate, let them use the colorful expressions of Klingon legend.

KOMEREX ZHA, THE GREAT GAME

To understand Klingon society, the concept of the *komerex zha* is essential. The *Klingonaase* word "zha" means "game", specifically a game of combat. Thus, *klin zha* is "the Klingon game", a chess-like contest that pits two players in a three-dimensional simulation of combat. Like our own chess, there are many variations (including some using Klingon warriors as playing pieces that actually do combat to stun or to kill). Great masters of *klin zha* command much respect in Klingon society.

Likewise, *komerex zha* translates literally as the game of empire, but it is far more serious than that. It is a major piece of Klingon philosophy. Remember that Klingons believe that every system, from a living organism up to a galactic government, is either *komerex* (growing and living) or *khesterex* (shrinking and dying). With this in mind, the game of empire is recognizable as the game of life itself.

The *komerex zha* is the game that Klingons play every day with each other, the game of seeking personal power while protecting what one already has. Individuals play it, lines play it, and the Empire plays it against the UFP and the Romulans. Some claim they do not play, or that the game does not exist at all. Others say that to deny the *komerex zha* is just another tactic in the game itself.

The many Klingons who look at life as a game of growth and manipulation of power are quite open about the fact that they play to win. Every action is a move in that game, and any individual who crosses the path of a Klingon had better be certain who is the player and who is the pawn.



GOVERNMENT

Klingon governmental structure can play an important part in a game, whether the player characters are Klingons or simply Star Fleet personnel coming into contact with the Klingon way of life. Remember that government, more than any other pursuit, is part of the *komerex zha*, and that almost nothing about the Klingons is either simple or obvious.

THE EMPEROR

At the highest level of government is the Emperor himself. The position is not hereditary, though being the son of a seated Emperor may give a Klingon a leg up on eventually getting the job (*if* he remains in favor with both his father and the Imperial Council). The Emperor has much power, and can make unilateral decisions affecting the entire Empire, but no Emperor who wants to remain on the throne for long would ever do so without knowing the position of the Imperial Council.

The Emperor maintains a private guard chosen from the best (and most personally loyal) combat troops in the Empire. Most Emperors also maintain an Imperial Flagship and sometimes a small fleet for their exclusive use, manned by the best personnel in the Klingon Imperial Navy. Some have ridden with that fleet into battle, while others have assigned the work of enforcing the Imperial will to commanders of unquestioned loyalty.

The Imperial Household consists of the Emperor's closest linefamily members and personal advisors. Many are resident in the Imperial Compound on Klinzhai, while others travel around as the most trusted eyes and ears of the Emperor.



Imperial Intelligence

Though Klingons believe that the stars remember the deeds done beneath their light, Imperial Intelligence sees what the stars cannot. Functioning like the Emperor's own personal secret service, it was first organized by Klingon Emperor Karagg (known as Karagg the Black) over a half-century ago. A new Emperor with an unsteady power base, he decided to create his own intelligence agency to serve as a watchdog over the activities of rival house lines, while maintaining complete allegiance to him. The organization quickly became the power behind the throne.

In the years since, Imperial Intelligence has solidified its position even further, though its actual structure is known only to the Emperor. No Emperor has tried to dismantle the group because it is now too powerful. Because Imperial Intelligence has often worked to strengthen an Emperor's (or an Imperial Council member's) position, a symbiotic relationship now exists between Intelligence members and most high-placed military and civilian Klingon officials.

Imperial Security

Also reporting directly to the Emperor is Imperial Security. Charged with internal protection of the *komerex*, it maintains constant surveillance of all members of Klingon society.

Not even members of the Imperial Council can avoid its probing eyes. In many cases, the orders of Imperial Security agents can countermand those of any military leader. Anyone a Klingon encounters might be an agent of Imperial Security, which penetrates every walk of Klingon life. Its agents are both hated and feared. This organization maintains the Emperor's control on the Empire through domestic espionage, terror, and intimidation.



IMPERIAL COUNCIL

The Imperial Council, for all intents and purposes, chooses the Klingon Emperor, and the Emperor continues to serve at the pleasure of this body. (At least, no Emperor has managed to hold office for long in the face of strong opposition from the Council.)

There are from 100 to 200 members in this Council at any given time, with 20 to 50 of them actually making most of the decisions. Council members are not elected. They are the chosen representatives of the most powerful family lines in the Empire. Some truly powerful families may have two or, on rare occasions, three representatives in the Council. Some have only one, while other families form coalitions of two or more lines to send one representative. Every line in the Empire, through some chain of alliances or coalitions, can claim to have some voice (however small) in the Imperial Council.

A member gets a seat in the Council when he amasses enough personal power and prestige (usually through line connections) to enter and claim it. If a claimant has so much clout that he cannot be ignored, he will be recognized as a Council member. The process is so highly ritualized that there are never any disputes. If everyone on the Council does not already know the claimant and respect his influence, then he had better not make a claim. If a member's influence wanes to the point that no one pays him any attention, he knows not to show up in the Council again.

Of course, there have been occasions when a Council member has lost his seat in an unusual fashion. Just after the Four Years War, one Council member suddenly discovered that he had lost the confidence of his line when a linebrother entered and announced the change by shooting the old Council member. The mess was cleaned up, the new Council member was seated, and business went on as usual. Most changes in the Council are not so dramatic, however.

The Council has its own auxiliary support services, including a small fleet of ships, a personal guard, and a liberal budget for operating expenses. Even so, it has no direct connection to the lower levels of government. The Council does not pass laws or give orders. Instead, it reviews matters of policy and informs the Emperor of its wishes.

No Emperor even tries to keep the Imperial Council to a simple advisory role, however. Instead, the Emperor appoints influential Council members (or those chosen by them) to offices in the government where they *do* give orders and make policy. Though the Emperor is supposed to be the sole arbiter of all Klingon life, he rules through and with the advice and consent of the Council. Every Council member has at least one official government appointment that he either holds personally or controls. The more influential members have several offices.

IMPERIAL HANDS

Next in direct line in the chain of command is the Imperial Hand of Klinzhai, who controls the administration of the homeworld, and the Imperial Hand of each of the four quadrants. Though he actually controls the least territory, the Hand of Klinzhai has the most power because the main body of the Imperial Fleet is under his control, as is the administration of most Imperial assets. The planetary governor of Klinzhai (really a rather minor official, chosen from among the ranks of those dedicated to the Administrative service) handles the day-to-day affairs of the planet, while the Hand of Klinzhai worries about controlling as much of the military and financial strength of the Empire as possible.

The four Hands of the quadrants vary in prestige according to the importance and income of their respective quadrants. The most powerful in recent years has been the Hand of Quadrant Delta, who administers the largest area, including the entire Organian Treaty Zone. Quadrant Beta, which faces the Orion Colonies, the Triangle, and the Romulan Star Empire, is the next largest and usually the next most influential. Quadrant Alpha's Imperial Hand has increased in prestige over the past 20 years, due to expansion along the area that was blocked before a formal Romulan/Klingon border was projected into unexplored space. Gamma's Hand has sometimes been called "the Forgotten Hand" because of its small size and the fact that it faces the region of space where the Klingons fought the Demon War. There has been little expansion of this area, but the necessary buildup of forces here since the Demon War ensures that the Hand of Quadrant Gamma will continue to be an important position. Of course, all the Imperial Hands are chosen from among the most influential members of the Council (or, in rare cases, are given to others at the request of these Council members).

The four quadrants are further divided (unequally) into 19 Naval Districts, according to the fleets that patrol and protect them. Each Imperial Hand administers his holdings in a similar fashion, gathering military and administrative leaders within these districts to serve in much the same way as the Imperial Council does for the entire Empire. Military chain of command follows down the districts, as discussed in a later section on the **Klingon Armed Forces**. Administrative chain of command proceeds similarly to District Overlords, Sector Overlords, and Planetary Governors, each usually having a council to guide them, more or less. At each level, the power and influence wielded by individuals and linefamilies is what decides matters of policy.

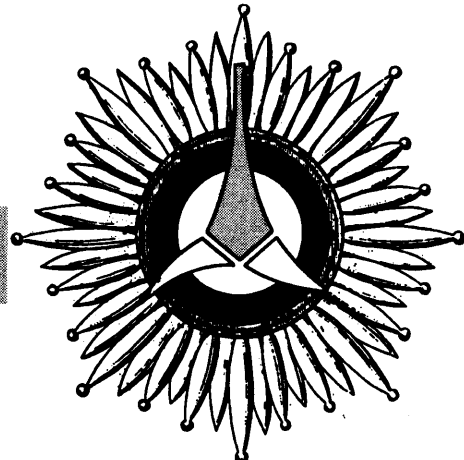
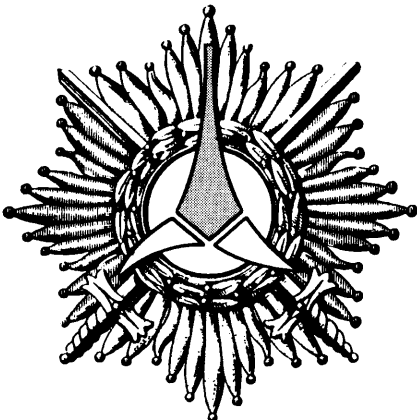

KLINGON ARMED FORCES

IMPERIAL NAVY

The Klingon armed forces center on their Naval forces. The Klingon Imperial Navy always receives first priority on personnel, equipment, and most especially, funding.

ORGANIZATION

Naval Districts

The whole of Klingon military might (and all of Klingon space) is organized into 19 Naval Districts, spread unevenly among the four quadrants of Klingon space. Alpha has three, Beta five, Delta seven, and Gamma has three, with the extra being the Klingon version of Civil Defense. This last district is based on Klinzhai, but its units also spread throughout the Inner Empire. These districts are similar to the 24 into which Federation space is divided. Just as in the UFP, the District Headquarters Commander can draw on personnel from any department to carry out a particular assignment.

The boundaries of districts are generally astrophysical in nature, though these borders may fluctuate slightly, depending on whether the District Headquarters Commander is in or out of favor with the Emperor at the moment. Sometimes a military district boundary temporarily overlaps the boundary of another quadrant, but the entire district is still under the District Commander's authority. There is one District Headquarters for each district, and these are known as star fortresses (the Klingon equivalent of star bases).

Operating Forces

Looking at the Imperial Navy Organization Chart, one can see that there is no separate branch for Klingon military operations (equivalent to Star Fleet Operations). This is because each District Commander controls all vessels operating in his district. Vessels, personnel, and equipment are assigned to these districts as needed. In typical Klingon fashion, District Commanders who use their prestige and influence most effectively get first shot at new equipment and better personnel. If a ship commander wishes to transfer out of an undesirable district, he must attract the right kind of notice through hard work, outstanding performance of duty, and perhaps a dose of bribery or pure treachery. Fleets are assembled and disbanded according to mission, which can last from a few weeks to years at a time.



Fleet Organization

Klingon vessels generally operate in squadrons of three vessels and in fleets of nine vessels. The only times a District Commander might assemble units into the third multiple of 27 vessels is in the case of smaller vessels or in times of declared war. These military forces do not appear on the Organization Chart as a separate department, because they are constantly changing in size and number. The squadron is a sub-unit of the Naval District to which it is assigned, but is above the District Offices for each of the Branches shown on the chart.

Klingons prefer not to trust a large number of vessels under one Admiral's command for fear of consolidating too much power in one individual. They generally group several squadrons or two fleets under various commanders, who are supposed to act together in some semblance of cohesion.

NAVAL BRANCHES

As shown by the Organization Chart, each Naval District includes offices for Exploration/Colonization, Intelligence, Installation/Logistics, Personnel/Administration, Medical, Communications, Plans/Policies/Fiscal, Sciences, Training, Engineering, and the ICB/KDC. The main office for each branch is in the Quadrant Headquarters, but each district has its own District Office.

Following are descriptions of each of the eleven branches.

ICB/KDC

See page 52.

Exploration/Colonization

Known in the Federation (unofficially) as the Exploitation Branch of the Klingon military structure, the Exploration/Colonization branch is a solid part of the military (unlike Star Fleet's similar branch), with all scouting units totally under Navy control. Because the exploring and colonizing functions are combined in one branch, it is the largest of all the departments. After all, Klingons want to colonize everything they can get their hands on. Though the Exploration/Colonization Branch includes Klingon scientists who are interested in scientific discovery for its own sake, most Klingon exploration teams are more apt to view a new world in light of how its discovery might profit the Empire.



KLINGON NAVY ORGANIZATION FLOWCHART

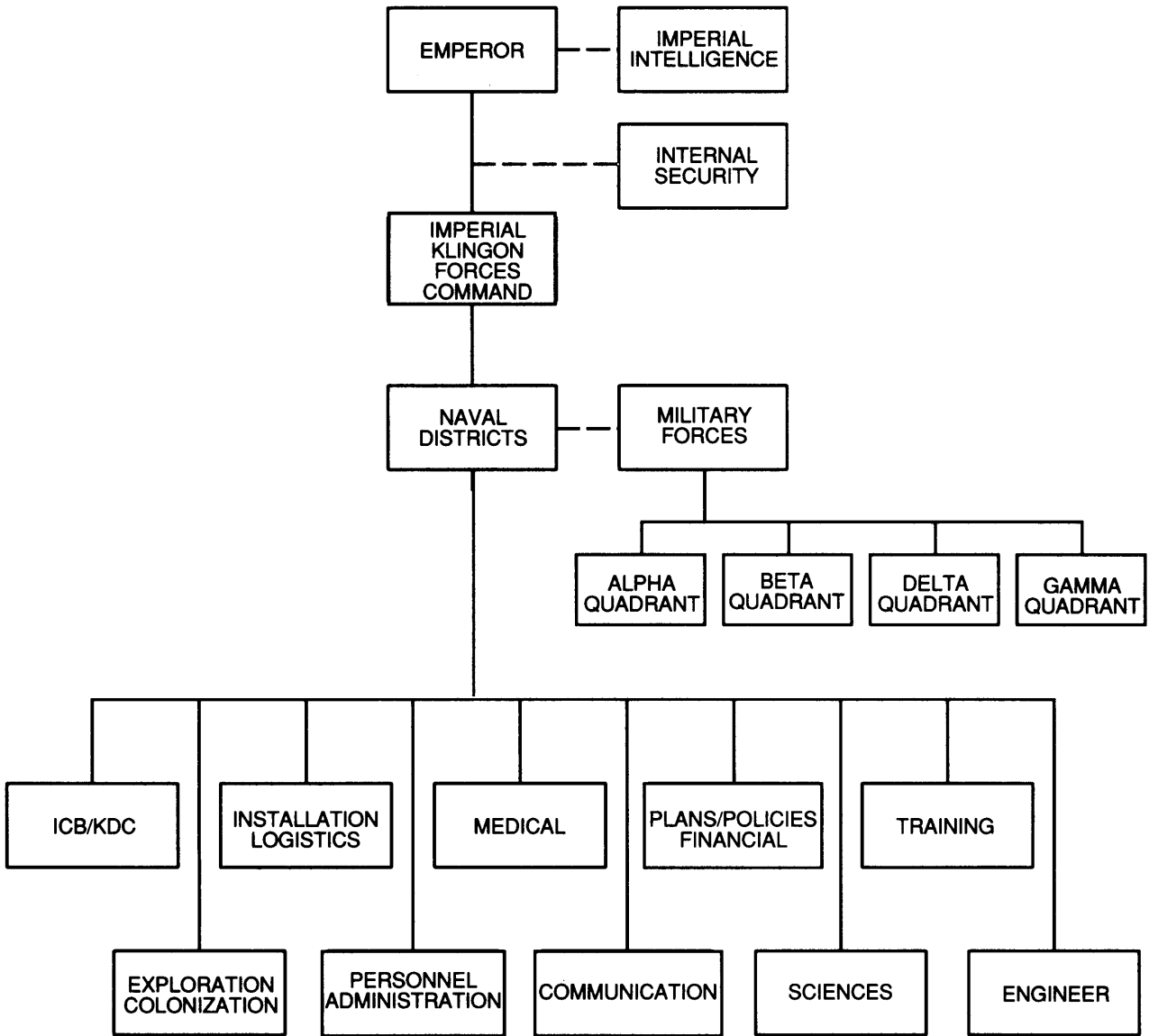

Once an exploration team has made a useful discovery, the colonization team takes over. To save time, however, the one team often serves both functions. Unlike UFP colonization teams, however, the Klingons have no scruples about taking over a world already inhabited by sentient life, although the ICB may intervene in such a situation. The colonization teams rarely turn a colony over to civilian authorities until it is considered well within Klingon boundaries. This branch is also responsible for establishing and manning all border outposts.

Security

The Security Branch is responsible for gathering data about the disposition, strength, and possible motives of military forces hostile to the Empire. They also collect data on the population, economy, habits, psychology and sociology, and any other information available about enemy civilian centers. No Klingon individual or group can escape the ever-present surveillance by Imperial Security.

Although the official mission of Imperial Security has not changed, the agency has been attempting to broaden its power base in recent years. In the last decade, for example, it has gained control of Naval and Marine training through their jurisdiction over the Imperial Star Academy Training Command. In fact, Security is making its presence increasingly felt at all levels of the social structure, from implementing special youth training programs to using agonizer booths for testing citizens' loyalty. In the near future, Security may even make efforts to supplant Imperial Intelligence as the mainstay of the Emperors.

A large autonomous agency, Imperial Security exists somewhere outside the existing framework of Klingon military and civilian organizations, willing and able to challenge the authority of an officer if they decide that the situation warrants his replacement.

Installation/Logistics

The I & L is the quartermaster of the Empire, responsible for constructing and maintaining all bases, both planet-side and orbital. The department is responsible for resupply of all vessels and installations, and it also handles all financial matters pertaining to installations, logistics, and procurement of new material.

Personnel/Administration

Personnel/Administration is charged with recruiting and keeping records of all personnel, active or retired. The department controls the forms, manuals, transfers, promotions, and other paperwork generated by the military structure.

Medical

The Medical Department handles all studies and personnel related to the medical field, including genetic research and unpleasant medical topics related to information-gathering.

Communication

This branch handles communications of all types, from sending a message within a ship to transmitting it across the galaxy. It also carries out R & D on communications equipment.

Plans/Policies/Fiscal

This single department handles all plans, policies, and monetary matters in the military structure.

Sciences

The Sciences Department is responsible for all military research not assigned to another branch. In contrast to Federation policy, almost all Klingon research is carried out under military auspices (with the exception of clandestine efforts by individual linefamilies).

Training

This department is responsible for all training in the IKF. As in the Federation, IKF training never ends, though individuals have less freedom of choice in the studies they will undertake.

Engineering

The Engineering Department is responsible for the maintenance, construction, and research of power units and related equipment for bases and vessels.

RANK, POSITION, AND TITLE

NAVAL TABLE OF RANKS

Recruit
Enlisted Second Class
Enlisted First Class
Petty Officer Second Class
Petty Officer First Class
Chief Petty Officer
Cadet
(Midshipman)
Ensign
Lieutenant Junior Grade
Lieutenant
Lieutenant Commander
Commander
Captain
Admiral

As discussed (accurately) in the **Star Fleet Intelligence Manual**, the rank of *Admiral* is a generic term for any Klingon officer above the rank of ship's captain. Different admirals can be distinguished by descriptive extensions to their titles. An Admiral of the Fleet, for example, has more power and responsibility than a Training Cadre Admiral.

A Cadet is a student at the Klingon equivalent of Star Fleet Academy; Cadets and Midshipmen (basically a passed Cadet) are just below Ensign on the Table of Ranks. Unlike his Star Fleet counterpart, the Klingon Cadet does carry the full responsibilities of an officer, along with the respect and courtesy due.

Squadron Leader is a position, not a rank, indicating which of the three captains in a squadron is in overall command. The position carries more weight on the frontiers, where squadrons are very independent (and are usually referred to by the Leader's name, e.g., Keth's Squadron). A Squadron Leader is still a captain, and might be addressed as "Captain" without insult, say, by another Leader. Lower ranks would rarely take the risk.

A Thought Admiral is a Fleet Grand Strategist. Though he has no direct command of ships, a Thought Admiral is (theoretically) above all other Naval Officers. It is not an organizationally defined position. There may be no Thought Admiral, and there may be as many as six. [NOTE: Though Klingons are master tacticians, they are not, by nature, strategists. They tend to mistrust those who take the long view—even other Klingons. Thought Admirals are often treated as somewhat useful but dangerously erratic.]

CHAIN OF COMMAND

If the Captain of a vessel is planetside, ill, injured, or otherwise unable to command, the following table shows the normal chain of command. If any officer in the sequence is also unavailable, the chain of command skips to the next available officer listed. Once these possibilities are exhausted, the chain of command follows the ranks from senior officer present on down.

CHAIN OF COMMAND TABLE (VESSEL)

Captain
 Executive Officer
 Chief Helmsman
 Chief Weapons Officer
 Chief Navigator
 Chief Communications Officer
 Chief Engineer



The planetside chain of command procedure works the same as for vessels. If some bases do not have all the positions listed in the following table, simply skip to the next available officer.

CHAIN OF COMMAND TABLE (PLANETSIDE)

Base Commander
 Deputy Base Commander
 Chief of Staff
 Chief Communications Officer
 Chief Engineer

UNIFORMS

The current standard Klingon uniform is gray and tan and is the same for all military forces. The leather vests are heavy enough to offer some protection from an enemy's (or assassin's) knife.

The Klingons do not have an equivalent of the Federation dress uniform. For special occasions, they usually add a sash with a colored kill stripe for each vessel they have defeated in combat. The different colors represent the specific enemy defeated. For example, Federation kills are in blue, Romulan in purple, and so on. The sashes themselves are of different colors: tan for the Navy, dark brown for the Marines, silver for detached service, blue for the KDC, and so forth.

Insignia

Klingon uniforms carry insignia denoting rank, but do not always indicate the wearer's duty assignment (as do Federation uniforms). Rank insignia are worn as a circular brass badge on the left collar. This collar device is the only clue to rank.

Most of the positions (including Admirals) do not have distinctive insignia, as all Klingons assigned to a vessel or base are expected to know their superiors on sight.

Many ship captains have also created unofficial ship insignia, which their crew wears. These are usually circular and made from brass, and worn on the right collar. The Klingon High Command is lenient about the use of these unofficial insignia because they help promote crew unity and morale. (See also the **Klingon Intelligence Briefing** for other examples of Klingon status symbols.)

NAVAL (MARINE) RANK INSIGNIA

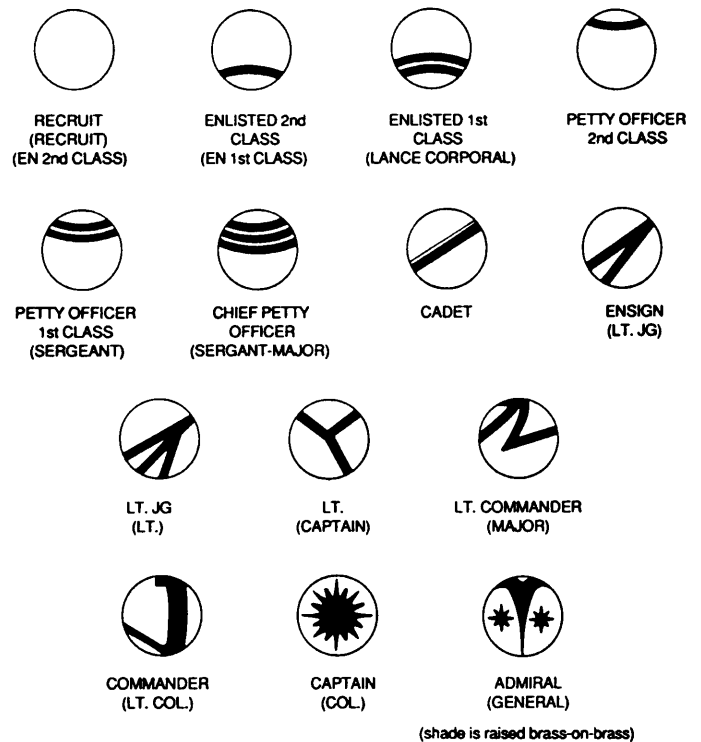

Decorations

Among the numerous Klingon military decorations awarded for valor in battle, the battle sashes described above are the most popular. The other battle decorations are usually rectangular or ovoid cloth shapes that can be sewn onto the tunic.

STARSHIP RECOGNITION FILE

D-7 (VARIOUS NAMES) CLASS VII-IX CRUISER

Introduced in Stardate 1/8611, the *D-7*'s design, weaponry, speed, and maneuverability soon made its name synonymous with death and destruction. It is not only the most infamous class of Klingon vessel, but also the most numerous. Thus far, the Klingons have produced six main variants, and the future may bring more. UFP forces first encountered the *D-7* during the Four Years War, when the Klingons had more than 400 *D-7*As on their front-line. It was this numerical superiority that gave the Klingons the edge in achieving their early advances into Federation territory during the war.

The Klingons have equipped the *D-7* with various types of armaments over the years, including plasma weaponry technology received from the Romulans through trade accords. Star Fleet has captured at least one of all the variants except the *S*, and the Romulans have secured versions *A*, *C*, and *M*. Of course, the Romulans also received some *D-7*s as part of the above-mentioned exchange agreements.

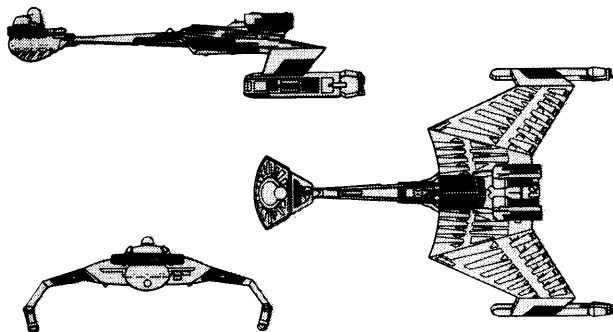

D-10 (RISKADH) CLASS VIII-X CRUISER

One of the most destructive vessels in the Klingon navy, the *D-10* first entered service in Stardate 1/9606, during the second year of the Four Years War. Until these ships had to confront the Federation's newly developed phaser and photon torpedo, the *D-10* was the most powerful and feared vessel in the Imperial Navy. Since then, there have been five variants. The powerful *H* model is the most recent, mounting ten disruptors and two torpedoes, one of these firing aft. Though the *D-10H* no longer carries the large complement of Marines that earlier models did, it remains one of the most menacing vessels in space today. Star Fleet has captured Models *A*, *D*, and *C*.

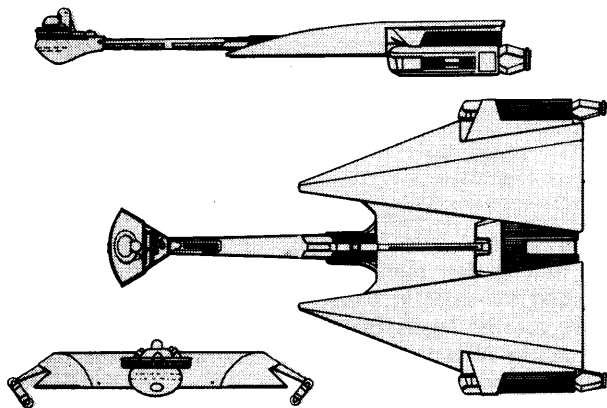

D-18 (GULL) CLASS VII-IX DESTROYERS

Though the Klingons have designed and built only three variants of the *D-18* so far, it is currently the most widely used destroyer in their navy. When the ship first entered service in Stardate 2/0108, the Klingons were still recovering from the Four Years War and so placed the first models on patrol along the Romulan and Triangle borders, well out of the Federation's way. The *D-18B* is the most common variant encountered today.

Its highly efficient KWE-3 warp system provides it with more maneuverability and more power for its weapons than its predecessors had. With its cruising speeds of Warp 8 and emergency speeds of Warp 9, the *D-18B* is now one of the fastest ships in known space. Star Fleet has captured both an *A* and *B* variant.

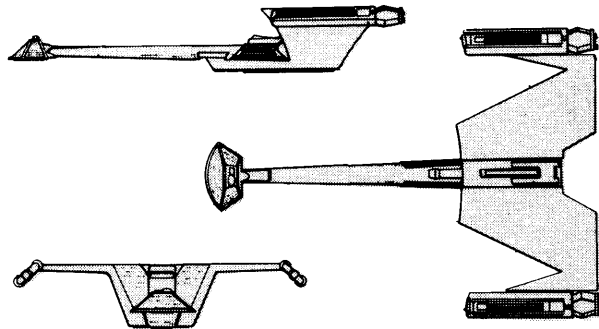

K-23 (LITTLE KILLER) CLASS VI-VIII ESCORT

With its angular design, the deadly *K-23* was a radical departure from typical Klingon ship designs when it was introduced in 1/9702, toward the end of the Four Years War. The main reason for the design change was the Klingon plan to confuse the Federation into believing that the Empire now had an unknown ally. To further the deception, the first *K-23*s that appeared in the war zone were crewed by Romulan Fusions. The ruse worked for about a year, until the Federation managed to capture one of the vessels and discovered the truth.

Five versions of the *K-23* have entered service to date, with the most recent being the *K-23F*. The vessels normally operate in escort groups of three, though smaller and larger formations have also been used. The newest version is the *K-23F*, which mounts aft weaponry as well as a strengthened hull and more efficient shielding. The majority of these have been sent coreward to participate in the ongoing war occurring along that border. Although Star Fleet has captured the *A*, *B*, and *D* variants of the *K-23*, neither the Federation nor the Romulans have sighted many of the dangerous *F* model.

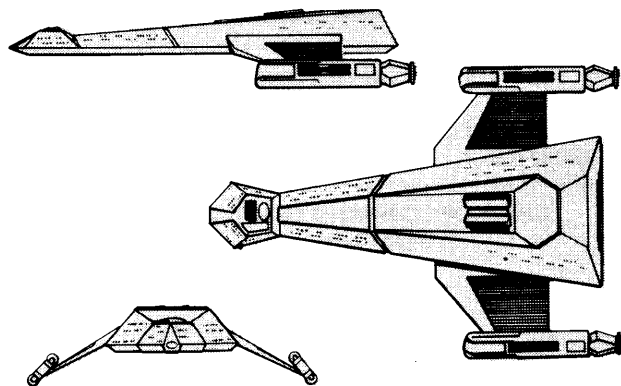

L-9 (SABER) CLASS X FRIGATE

The L-9 combines the angular design of the K-23 escort with the standard command boom and pod. The earliest model, introduced in Stardate 2/1507, was devastating in close combat, but its offensive range was only 60,000 kilometers. To correct this weakness, some later versions were made even more powerful close in, while others were equipped with weapons that had greater range. The L-9G, latest of the five models produced thus far, carries fewer troops in order to house the RPL-1 plasma weapon mounted in its lower main hull. This variant operates along the Empire's coreward borders. Star Fleet has captured only an L-9A, the first variant, which is no longer in service.

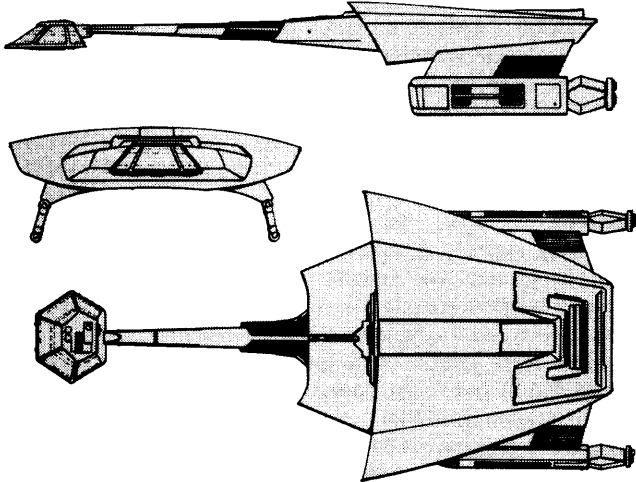

L-42 (GREAT BIRD) CLASS IX-X FRIGATE

The L-42 is the largest vessel type produced as a direct result of the latest Klingon/Romulan technology exchange. The first model entered service in 2/2101. With a hull design similar to that of a Romulan scout, these frigates resemble the Klingon K-22 or D-32, with its variable position wings. In the down position, the vessel slows for the kill. In the horizontal position, it can reach Warp 9 for short periods of time. Two variants have been produced. The L-42A's efficient engines provide high maneuverability and extra power to its weapons and shields. Though the L-42B's increased superstructure and two forward-firing and two aft-firing KP-6 torpedoes make it more powerful, it is not as maneuverable. The vessel operates along the Triangle and Romulan borders, and not one has ever been taken by an enemy power.

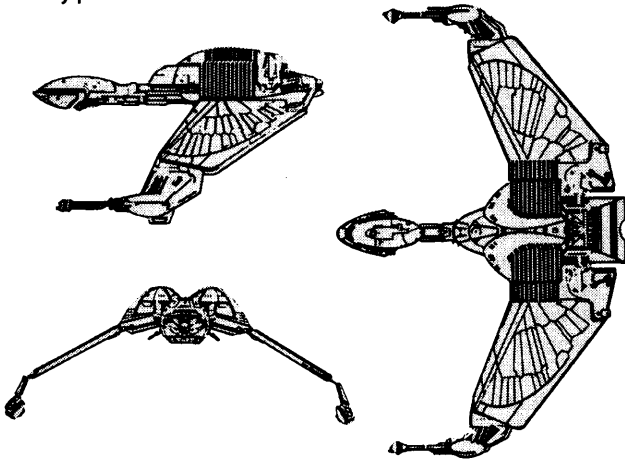

Z-4 (DEATHGAME) DEFENSE OUTPOST

The Z-4B was first put into operation in Stardate 1/8902, five years prior to the start of the Four Years War. The Klingons used it to supplement their forward listening posts in areas where they wanted to deny or restrict enemy movement. Since that time, more than 500 Z-4s have been constructed. At major defense points such as star fortresses, more than one may be in use. (At several points along the Federation and Triangle borders, there are as many as eight in place.)

The Z-4B was effective for 30 years before it became necessary to upgrade it with the Z-4C. With its formidable weaponry and offensive range of 200,000 kilometers, the C model is even more effective in carrying out its mission.

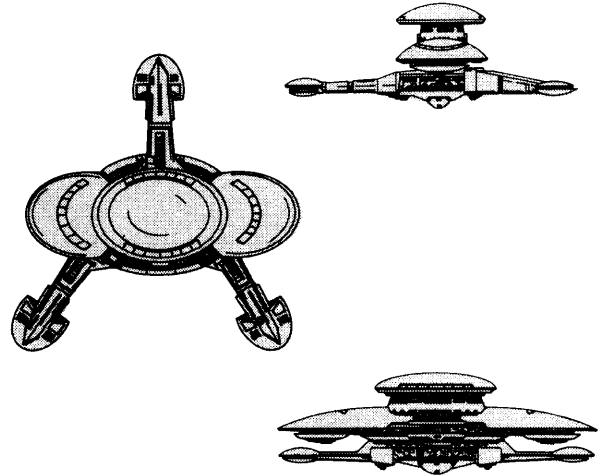

D-32 (STRONGER BIRD) CLASS VII CRUISER

One of the newest vessels in the Klingon Navy, the D-32 is the direct result of the latest Klingon-Romulan technology exchange. It is, in fact, a smaller version of the L-42 frigate, with one major difference. Its movable wings are capable of the 'up' position, which permits the D-32 to perform atmospheric operations. The D-32B was first commissioned in Stardate 2/2004. The newest model is the D-32C, which uses Romulan plasma bolt weaponry, is better shielded, and has a stronger superstructure. Some vessels of both model types also use the KCC cloaking device.

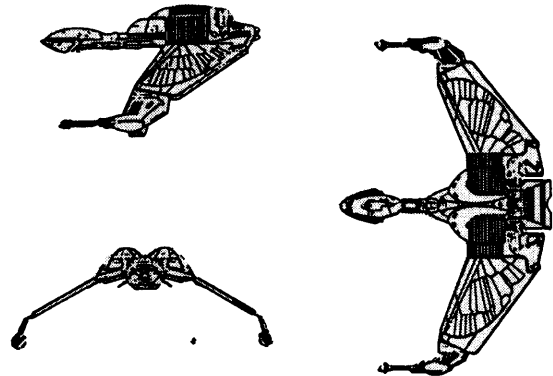

THE IMPERIAL MARINES

The Klingon Marine forces take second place to the Navy in regard to the assignment of personnel, equipment, and even weaponry.

ORGANIZATION

Imperial Marines are assigned to the Naval forces in piecemeal fashion, with the Marine Combat Force being the largest unit of organization. Made up of any number of battalions, The Combat Force is usually together only for large operations or on paper, for organizational purposes. As with Naval units, Marine units are assigned as needed, and there is usually much friction between high-level Marine and Naval Officers.

The largest unit found on board a regular line ship is the battalion, which fits comfortably on *D-7s* and other line ships.

Marine units are usually kept together on the battalion level. Some units are specially trained to fight in different environments, be it free-fall or hazardous atmospheres.

RANK, POSITION, AND TITLE

MARINE TABLE OF RANKS

Recruit
Enlisted Second Class
Enlisted First Class
Lance Corporal
Sergeant
Sergeant-Major
Lieutenant Junior Grade
Lieutenant
Captain
Major
Lieutenant Colonel
Colonel
General

The rank of General is generic in the Imperial Marines, just as that of Admiral is in the Navy. The differences among the myriad generals in the Klingon Marines relate to the duties the individual performs and what position he holds.

CHAIN OF COMMAND

CHAIN OF COMMAND TABLE

Unit Commander
Executive Officer
Sergeant-Major
Sub-unit Commanders

The same chain of command procedures apply to the Marines as the Navy. A Marine 'Force Leader' is in command of one ship's complement of Marines. This includes all ship's troops except those assigned to Ship Security, who are under the Security Chief's orders.

UNIFORMS, INSIGNIA, AND DECORATIONS

Refer to the Naval section for details on Marine uniforms.

MARINE TACTICS

In any operation, the philosophy of the Klingon Marines is to take their objective as quickly as possible. To accomplish that, they rely heavily on the single tactic of beaming directly onto their objective. Even though losses

may be heavy because the enemy is jamming signals, the Klingons feel that these losses are acceptable in carrying out their task. Once they have seized the objective, the Klingons beam or fly in portable shield generators in order to keep what they have won.

Most Klingon soldiers are not versed in tactics, but rather, are trained to follow orders to the letter. This is not to say that the average Klingon soldier is incapable of independent action, but that his training does not encourage him to do so.

ICB/KDC

Though shown as a branch of the Navy, the ICB/KDC operates semi-autonomously. The Klingon Diplomatic Corps (KDC) is a major component of the Imperial Contacts Branch, whose task is to represent the Empire on various independent worlds and with the major interstellar powers. Its second major responsibility is to bring new worlds under Imperial hegemony by any means short of outright military conquest. Covertly, the KDC is charged with creating, organizing, supporting, and maintaining those activities that might undermine the stability of pro-Federation or pro-Romulan factions outside the *Komerex*. The primary tool of these various operations is the KDC liaison team.

The KDC liaison team (sometimes referred to as a contact team) goes into operation once a Klingon survey party has determined that a planet is of economic or military value to the Empire. As soon as the survey party persuades the local populace to welcome a Klingon deputation, the liaison team arrives to promote the advantages of relations with (and, eventually, union with) the Klingon *Komerex*. (Obviously, they downplay the military heavy-handedness often associated with Klingon expansionism.) KDC liaison teams are made up of specially selected, highly trained individuals willing to sacrifice personal pride and honor in the interest of the Empire.

The principal tactic of the KDC is to increase tensions among various groups on independent worlds whenever such political infighting would further the Empire's interests. Sometimes this leads to what used to be known as a War of National Liberation, though the Contacts Branch often rigs the outcome, either by supplying weapons to one side or by intervening in favor of the enemy of the side the Klingons pretend to be 'helping'. The ICB also stages pirate raids and 'terrible accidents' to justify Imperial interventions.

Despite its often underhanded methods, the ICB actually does conduct real diplomatic operations. The Empire is always looking for willing allies, but must first ascertain whether a potential ally may be a culture stronger or more ruthless than the Klingons' own.

The Klingon Diplomatic Corps is organized into 19 districts, just as are the Naval forces. (This helps the Corps to run smoothly, and also to carry out its secondary function of keeping an eye on the Klingons' own military and civilian populations.) KDC ranks also follow the exact format of Naval ranks. The similarities end there, however. KDC members rarely wear uniforms, because they often assume undercover roles. On the other hand, some KDC personnel have a position in the regular Imperial forces, which they use as a cover for their operations. Those KDC members who function openly as diplomats are normally from the Administrative service. They wear an insignialess version of the Klingon naval uniform in black and light blue, which is what passes for civilian formal wear in the Empire.

KLINGON MARINE ORGANIZATION FLOWCHART

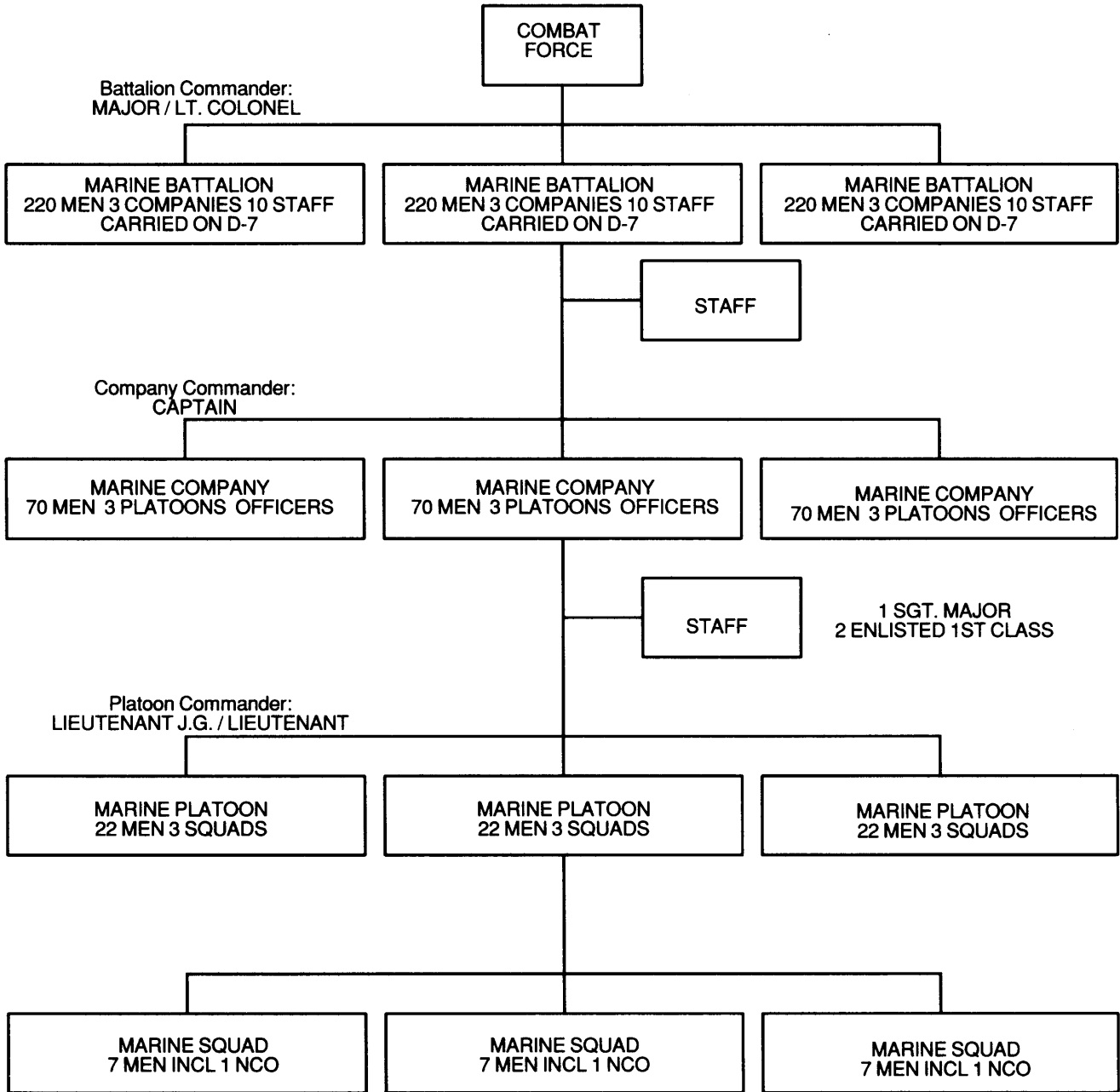

CREATING KLINGON PLAYER CHARACTERS

DEFINING KLINGON CHARACTERS

As a race, Klingons are even more diverse than Humans. There are at least three separate sub-races: the Imperial Klingons, the Klingon/Human Fusion, and the Klingon/Romulan Fusion. The fusion races are the result of genetic engineering, however, *not* of natural evolution. (See **The Klingon People**.)

Klingon characters are based on the same skills and attributes that are given for Star Fleet characters in STRPG2. This chapter explains how these skills and abilities are expressed through the Klingon race.

[NOTE: Only in the rarest of circumstances will members of more than one sub-race serve together on a ship. Occasionally, Imperial Race Klingons will serve among a predominantly Human Fusion or Romulan Fusion crew, but members of the two Fusion races will *never* crew together on the same ship.]

ATTRIBUTES

The seven attributes are Strength (STR), Endurance (END), Intellect (INT), Dexterity (DEX), Charisma (CHA), Luck (LUC), and Psionic Potential (PSI). As with Star Fleet Officers, these numbers will not normally change during the course of the game. For descriptions of each attribute, see **Defining a Character** in the STRPG2 *Star Fleet Officer's Manual*.

SKILL LIST

Administration	Personal Weapons Technology
*Artistic Expression	*Physical Sciences
Bribery	*Planetary Sciences
Carousing	*Planetary Survival
Commun. Systems Operation	Security Procedures
Commun. Systems Technology	Shuttlecraft Pilot
Computer Operation	Shuttlecraft Syst. Technology
Computer Technology	Small Equip. Syst. Operation
Damage Control Procedures	Small Equip. Syst. Technology
Deflector Shield Operation	Small Unit Tactics
Deflector Shield Technology	*Social Sciences
Electronics Technology	*Space Sciences
Environmental Suit Operation	*Sports
Gaming	Starship Combat Strat./Tactics
Instruction	Starship Helm Operation
Interrogation	Starship Sensors
*Language	Starship Weaponry Operation
Leadership	Starship Weaponry Technology
*Life Sciences	Streetwise
Life Support Syst. Technology	Surveillance
*Marksmanship, Archaic	Transporter Systems Procedures
Marksmanship, Modern	Transporter Syst. Technology
Mechanical Engineering	*Trivia
*Medical Sciences	Vehicle Operation
Negotiation/Diplomacy	Warp Drive Technology
*Personal Combat, Armed	Zero-G Operations
Personal Combat, Unarmed	

SKILLS

Klingon characters have and use the same skills described in the STRPG2 rules. To help make Klingons realistic as characters, the following section describes additional new skills or clarifies how Klingons use skills familiar from the basic rules set.

Artistic Expression

Klingon art is more martial than Human art, and is mostly of the realistic school. More tolerated than respected, Klingon artists are expected to use their talents to glorify the warrior/conqueror theme. Most artists in the Empire are members of servitor races.

Bribery

Bribery skill involves the subtle negotiation of bribes, kickbacks, and other quasi-legal and illegal payoffs. This skill comes into play whenever a character must make a secret payoff or find a corruptible official whom he can bribe. Failure of a Skill Roll against the *Bribery* Skill Rating means that the authorities have detected the attempt, either because the bribe was not subtle enough, large enough, or because the official was not as corruptible as he had at first seemed.

Gaming

Gaming skill includes knowledge of the basic forms of *klin zha* (Klingon chess), a skill that few warriors lack. The game is also an integral part of Klingon history and politics, which are known as the *komerex zha*, or the perpetual game of empire. The game has great status in the Empire, which makes *klin zha* grandmasters highly regarded. Any character with a *Gaming* Skill Rating of 40 or higher is considered a master, while a Skill Rating of 80 or higher confers grandmaster status.



Interrogation

Skill in *Interrogation* governs the questioning of prisoners, sometimes under duress or torture. When attempting to interrogate a prisoner, a character must make a Skill Roll against his *Interrogation* Skill Rating. If the roll is successful, the victim may try a Saving Roll against his INT if the interrogator is using trickery, or against his END if he faces duress or torture. If the victim's roll succeeds, he reveals no information. Otherwise, the questioner receives at least one piece of significant information. The gamemaster may adjust the victim's saving roll up or down, depending upon the importance of the information and the character's training and temperament. For instance, a highly trained Star Fleet Security Officer would be less likely to break under interrogation than would a civilian.

If tortured, the victim will, of course, take some wound damage. For each torture attempt, the victim will lose 1D10 END points. In fact, if the interrogator succeeds at his Skill Roll against *Interrogation*, and the victim misses his Saving Roll against END by more than 20 points, the victim takes an additional 2D10 points of wound-type damage and passes out. In either case, the amount of damage may be reduced by half if the victim is attended by support devices and/or medical personnel who can make the appropriate Skill Rolls against their *Medical Sciences*, *General Medicine* Skill Rating. If the victim does pass out, they may revive him immediately, and the interrogation process must begin again. The victim may not be revived if his CURR OP END falls below his Unconsciousness Threshold. It is possible to administer medical aid to raise the END before continuing the torture, however.

[NOTE: Because Vulcans know mental techniques to block pain, it is impossible to torture information out of one. Many secret agents have learned similar techniques, which gives them a 20-point bonus to all Saving Rolls to withstand pain.]

Social Sciences, Federation History

For Klingon characters, knowledge of Federation history represents the somewhat slanted view taught in Klingon schools.

Social Sciences, Klingon History

A Klingon character's knowledge of his racial history is based on the mostly accurate "official" version.

Social Sciences, Klingon Law

Because of the shifting nature of Klingon politics, Klingon civil and criminal law changes more often than its Federation counterpart. Skill at Klingon law does not include knowledge of the internal laws and traditions of individual clanlines, however. A Klingon will automatically know his own line's rules completely. If a character somehow has a chance to learn the laws and traditions of another line, he must learn them under the *Trivia* skill category.

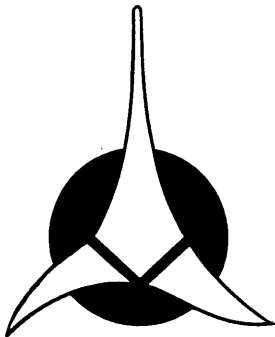

Sports, Swimming

This skill covers the techniques involved in swimming and diving (not skin or SCUBA diving, but including competition diving). A character with a minimum skill rating of 5 in *Swimming* is able to swim (or at least float) well enough to survive for a short period of time in water over his head. A minimum skill rating of 10 gives the ability to swim as recreation without fear of drowning, under normal circumstances.

Those with skill ratings of 20 or more are very competent. A skill roll against this skill might be needed if a character must perform an unusual feat of swimming skill, such as rescuing a drowning person or swimming long distances, or under adverse conditions such as fast current or extremely cold water, competing in water athletics, etc.

All graduates of the Klingon Imperial Star Academy receive a minimum Skill Rating of 5 in *Swimming*.

Surveillance

The art of *Surveillance* involves seeing without being seen, either personally or through technological devices. In game terms, the skill should be used to keep Klingon characters properly paranoid. A successful Skill Roll against *Surveillance* allows one character to follow another without being spotted. In some cases, however, the gamemaster may allow the target a chance to spot his tracker, with a Saving Roll against his INT.

If a character suspects that a plot or coup is in the offing, he may request that the gamemaster make a Skill Roll against *Surveillance*. The gamemaster will do so, but he does not reveal the exact outcome of the roll to the player. Instead, if the roll is successful, the character will hear a rumor or glean some other evidence. If the roll fails by less than 20 points, the character will hear nothing. If the roll fails by more than 20 points, however, the character will hear a *false* rumor! If no plot exists, the player will hear nothing. If there is no plot but the gamemaster's secret skill roll failed by more than 20 points, he may mislead the character into believing there is a plot.

Gamemasters may wish to make secret rolls for some characters, even when not requested. These might occur when someone with an established surveillance network (a Klingon ship Captain or Security Chief, for example) has a chance to accidentally pick up some important information. If such a roll succeeds, the gamemaster may reveal a bit of information to the character. Again, he may give false information for spectacularly failed rolls.

If a character attempts to detect suspected electronic surveillance and/or to defeat any known surveillance efforts, he must make a successful Skill Roll against his *Surveillance* Skill Rating.

Technology and Procedural Skills

Klingon characters may use non-Klingon equipment, but skill ratings to use that equipment are effectively halved for such operations. Thus, a Klingon with a Skill Rating of 48 in *Transporter Operation Procedures* will roll against a Skill Rating of 24 to successfully use a Federation transporter. This does not apply to *Marksmanship* skills, however, as most personal weapons are similar enough that a user's skill with one type of energy weapon will allow him to use any energy weapon.

This penalty is negated if the character can make a successful Skill Roll against the appropriate *Language* Skill Rating, or has had time to become familiar with the controls, either through extensive trial and error or with the guidance of someone who either reads the language or who is of the appropriate race to instruct the character.

GENERATING KLINGON CHARACTERS

As in Star Fleet-based games, Klingon player characters should be officers of the Imperial Fleet. This is even more important in the Klingon context because the Empire's enlisted personnel have virtually no decision-making power at all. The following sections provide all the necessary rules to generate the attribute scores and endurance statistics of Klingon characters. It follows the same format as that used in the STRPG2 *Star Fleet Officer's Manual*, which should be kept handy. All tables have been adjusted to reflect the differences between Humans and the various forms of the Klingon race.



Accompanying these rules is a running sample that explains the step-by-step process of generating a Klingon player character named Kevinn.

ASSIGNED SHIP, RANK, AND POSITION

After the gamemaster has decided on what type vessel will serve as the characters' home base, and what positions will be open to player characters, each player must choose the positions his character will fill. Finally, that player and the gamemaster determine what rank the character will eventually hold. The assigned ship, position, and rank, along with the character's name and gender, are recorded on the **Klingon Character Data Record**.

[NOTE: The character's gender may have some bearing on his place in Klingon society. Though women do attend the Academy, only a small number actually make it into the program. If a woman is talented enough, however, the Empire will not waste her talent by refusing admission. Women are not trained in the important areas of leadership, however, but are restricted to the Sciences, Medicine, Engineering, and Communications.]

Kevinn will eventually end up as the Captain of an L-9 Class X frigate. He will be a Helm/Navigation Specialist, with the rank of Captain.

CHOOSING A RACE

A Klingon character may choose one of three sub-races: Imperial, Klingon/Human Fusion, or Klingon/Romulan Fusion. Record the character's race on the **Klingon Character Data Record**.

The gamemaster decides that the ship will be manned by Imperial Race Klingons, so Kevinn automatically becomes an Imperial Klingon.

CREATING ATTRIBUTE SCORES

Attribute Scores are created by rolling dice and then applying the racial modifiers unique to the character's sub-race. Bonus points are then applied to build a unique character.

Initial Dice Roll

To determine the character's Attribute Scores of STR, END, INT, DEX, and CHA, roll 3D10 and add 40. This means that the lowest number possible is 43 (1 + 1 + 1 + 40 = 43), the highest is 70 (10 + 10 + 10 + 40 = 70), and the average is 57 (43 + 70 = 113; 113/2 = 56.5, rounded up to 57). The LUC and PSI scores are determined by rolling percentile dice (D100).

Racial Modifiers

Characters created with these rules represent the fittest and finest that the Klingon Empire has to offer. Klingons are trained from birth to fight and survive, and so are actually a bit stronger than Humans. They are not as lucky as Humans, however, and they shun psionics.

After rolling up the basic Attribute Scores, apply the appropriate racial modifiers from the Racial Modifiers Table. If the Attribute Score is 0 or less, adjust it upward to 1.

RACIAL MODIFIERS TABLE

	STR	END	INT	DEX	CHA	LUC	PSI
Imperial Race	+10	—	—	+5	-30	-40	-60
Human Fusion	+10	+5	—	—	-20	-40	-50
Romulan Fusion	+10	+10	—	—	-10	-40	-40

To determine a character's LUC and PSI scores, roll percentile dice (D100), then apply the appropriate racial modifier to the result. Again, for a score of 0 or less, adjust it upward to 1.



Bonus Points

Bonus points are distributed among a character's Attribute Scores to help individualize and tailor the character to the player's taste. To determine the number of bonus points available, roll percentile dice and divide by 2 (round down). These points may be added to any attribute except PSI, with two restrictions: No more than 30 points may be added to one attribute, and no attribute may be adjusted to more than 99 by using bonus points.

Kevinn is now ready to create his Attribute Scores. He rolls 3D10 (7, 4, and 1, for a total of 12) and adds the total to 40. Kevinn's STR score is 52. The other Attribute Score rolls are: END = 51, INT = 61, DEX = 58, CHA = 59, LUC = 98, and PSI = 24.

We now add the racial modifiers for the Imperial Klingon sub-race to his Attribute Scores. These adjusted scores are:

STR = 62 (52 + 10),	END = 51 (51 + 0)
INT = 61 (61 + 0),	DEX = 63 (58 + 5)
CHA = 29 (59 - 30),	LUC = 58 (98 - 40)
PSI = 1 (24 - 60 = -36, adjusted upward to 1)	

Kevinn's player rolls 48 on percentile dice, and so he may distribute 24 bonus points among his Attribute Scores. He chooses to add the points to Kevinn's CHA and END scores. The final Attribute Scores are: STR = 62, END = 55, INT = 61, DEX = 63, CHA = 49, LUC = 58, PSI = 1.

This completes the determination of character attributes. These scores do not change by normal means during the game, though the gamemaster may alter them as a result of an accident or other extraordinary occurrence in an adventure. As stated above, these individuals are the best the Klingon Imperial Fleet has to offer, for the weak of mind and body simply do not survive the screening process.

Unlike Federation characters, Klingon characters at this stage are about twelve Terran years old. Klingons mature earlier and age faster than Humans, and their training as warriors begins at birth. These facts will further affect the character generation process, as we shall see.

CREATING ENDURANCE STATISTICS

Each of the six endurance statistics is discussed in detail in the STRPG2 rules section on **Injury, Medical Aid, and Recovery**. The formulas and data are repeated here for the sake of convenience.

As in STRPG2, a character's END score is used to determine his Maximum Operating Endurance (MAX OP END), which describes his overall physical condition, and his Current Operating Endurance (CURR OP END), which describes his condition from moment to moment, including his fatigue. The character's Wound Healing Rate and Fatigue Healing Rate are also determined from the END score. How to calculate these is given below.

Inaction Save Level and Unconsciousness Threshold

A character's Inaction Save Level (INACT SAVE), the point at which he can no longer function normally because of injury or fatigue, is fixed at 20, as in STRPG2. A character's Unconsciousness Threshold (UNC THRESH), the point at which a character passes out, is fixed at 5. These values are already printed in the appropriate boxes of the **Klingon Character Data Record**.

Maximum Operating Endurance

At the start of the game and at all times when the character is not wounded, the Maximum Operating Endurance (MAX OP END) is the same as his END score. Wound damage is subtracted from this score. Because this number can change when the character suffers wound damage, it should always be written in pencil. This number can never become higher than the character's original END score, however.

Current Operating Endurance

The Current Operating Endurance (CURR OP END) is also the same as the character's END score at the beginning of the adventure and when he is not wounded. As fatigue, stun damage, or other temporary damage buildup, it is subtracted from this score. Because the number varies with the character's physical condition, record it in pencil. Like the MAX OP END, this figure can never become higher than the character's original END score.

Wound Healing Rate

How quickly a character recovers from injury is also based on his END score. To determine the Wound Healing Rate (WOUND HEAL RATE), divide the character's END score by 20. For Fusion races, round down. For Imperial Race Klingon characters, round the resulting score UP. This result is the number of wound damage points (from MAX OP END) that the character will heal in one day.

Fatigue Healing Rate

The Fatigue Healing Rate (FATIGUE HEAL RATE) tells how quickly a character recovers from temporary damage. To determine the number, divide the character's END score by 10. Again, Imperial Race Klingons round this score UP, while Fusion race characters round down. This is the number of points of temporary damage (from CURR OP END) that will be healed after 30 minutes of rest.

Kevinn's endurance statistics are as follows:

INACT SAVE = 20
UNC THRESH = 5
MAX OP END = 55
CURR OP END = 55
WOUND HEAL RATE = 3 (55/20 = 2.75, rounded up to 3)
FATIGUE HEAL RATE = 6 (55/10 = 5.5, rounded up to 6)

CHARACTER AGING

In most cases, Klingons have a slightly shorter lifespan than Humans. The critical age at which a Klingon character's scores for STR, DEX, and END may fall off is 40 for Imperial Race Klingons, 45 for Klingon/Human Fusions, and 60 for Klingon/Romulan Fusions. For each ten full years a character has lived beyond the critical age, roll 1D10 for each of the STR, END, and DEX attributes and reduce the score by the amount rolled. Once the game is under way, players may use the year-by-year aging LUC saving roll, as described in the STRPG2 basic rules.

TRAINING PLAYER CHARACTERS

Once a player knows what position his character will fill, he must provide him with proper training for the role. Creating a complete list of the skills a character has learned up to the time that the adventure begins is a complex but rewarding process. Once complete, it reveals the stages of the character's career as well as insight into Klingon methods of education and training. These skills are generated using the ST:RPG2 rules, and are gained in a step-by-step fashion.

The training process may take longer (in terms of service time) for some characters than others, providing for varying ages of the characters at the start of the game. Remember that the volatile nature of Klingon politics and promotions makes Klingon characters tend to rise through the ranks faster than do Federation characters. The average Klingon character will usually be younger than his Federation counterpart. This is acceptable, because Klingons have a shorter lifespan than do Humans and will be subject to aging effects earlier. The life of a Klingon officer is often short and glorious.

The list of Klingon skills is similar to the one in the basic rules, with some new additions. As always, a skill preceded by an asterisk (*) requires further definition. Players must choose a specialty or specific class for their character as well.

As the skill ratings are created, record them in pencil in the appropriate spaces of the *Klingon Character Data Record*. When the rating increases with the character's further training, replace the old value with the new one.



PRE-ACADEMY SKILLS

The Imperial Klingon Fleet maintains an academy for officer candidates, where those able to meet the rigorous admissions standards are trained to lead. Unlike their Star Fleet Academy counterparts, however, students of the Imperial Klingon Star Academy begin their training at age twelve. Having been carefully observed and screened since birth, only those who show a healthy aptitude for leadership are admitted to the Academy. (It goes almost without saying that they also tend to have a healthy respect for existing authority.)

No young person unable to meet the stringent warrior standards of the Empire would ever reach the Academy. Those judged to be not intelligent, strong, or fast enough to make good leaders are funneled into other forms of military service. The unfortunates who are deemed unsuitable for any military duty at all are trained as farmers, tradesmen, or other work that marks them as second-class citizens.

Those who *are* suitable are trained early in the use of weapons and the martial arts. For this reason, Klingon youths tend to be more skilled in these areas prior to entering the Academy than their Star Fleet counterparts. This is reflected by a separate category for Martial Skills in the Pre-Academy Skill Lists.

To determine the number of pre-Academy skills a character has, divide his INT score by 10 and round down. These skills must be chosen equally from all three Pre-Academy Skill Lists, i.e., one-third from Personal Development, one-third from Martial Skills, and one-third from Education Background.

For each skill chosen, roll 1D10 to determine the character's skill rating. A player may choose any skill more than once to further build up his rating. To do so, he rolls the dice twice, then adds the results together. For skills like *Languages*, *Sciences*, or *Trivia* (marked with an asterisk), the player must further specify the skill designation.

Unlike the system in the basic game, there is no provision for a character to begin the Academy as a medical doctor when he is older. In the Klingon Empire, the military hierarchy controls the administration of medical care. A character may *learn* some medicine in the pre-Academy procedure, but he receives no *formal* training before entering the Academy and being assigned to learn medicine. There are likewise no automatic promotions for medical personnel. Medicine is considered an unfit profession for a warrior, and honorable only for women and cripples. Nonetheless, the need for qualified medical personnel means that a number of able-bodied males must be assigned to this area, like it or not!

IMPERIAL STAR ACADEMY

KLINGON PRE-ACADEMY SKILL LISTS

Personal Development

Administration
 *Artistic Expression
 Bribery
 Carousing
 Gaming
 Instruction
 *Language
 Leadership
 *Planetary Survival
 *Sports
 Streetwise
 *Trivia

Martial Skills

*Marksmanship, Archaic
 *Marksmanship, Modern
 *Personal Combat, Armed
 *Personal Combat, Unarmed
 Small Unit Tactics

Education Background

Computer Operation
 *Life Sciences
 Medical Sciences, General Medicine
 Medical Sciences, Psychology
 *Planetary Sciences
 Social Sciences, Klingon History
 Social Sciences, Klingon Law
 Space Sciences, Astronomy
 Space Sciences, Astrophysics
 *Vehicle Operation (except space vehicles)

Kevinn must now select his pre-Academy skills. Because his INT is 61, he receives six skills from these tables ($61/10 = 6.1$, rounded down to 6). He must divide these equally between the three tables. For each skill chosen, he rolls 1D10 to determine the skill rating.

From the Personal Development Table, he rolls a 4 in *Administration* Skill to learn something of how the government and its bureaucracy work. He also rolls a 6 in *Gaming*, to learn the basics of playing *klin zha*.

For his Martial Skills, he rolls a 5 in *Personal Combat, Unarmed* and a 4 in *Marksmanship, Modern*.

To complete Kevinn's pre-Academy skills, his player turns now to the Education Background list. To learn some first aid, he rolls a 3 in *Medical Sciences, General Medicine*. He also rolls a 5 in *Computer Operation*, which gives him some basic skills and understanding.

All six skills are now entered on the *Klingon Character Data Record*.



Graduates of the Imperial Klingon Star Academy are among the best-disciplined and most highly motivated of all the starfaring races. Having conquered the rigors of the Academy, each graduate has good reason to believe he is fit to conquer the unknown dangers of space.

Cadets begin their training at the Star Academy at age twelve. Each trainee enters as an officer candidate, but is referred to as "wretched scum" by the faculty. From the moment of arrival, cadets automatically become wards of the state, with all privileges of line honor or connection suspended for the duration of their stay. Any advantages a cadet may have enjoyed previously will not be restored until his graduation or dismissal. During his time at the Academy, each individual is undisputed state property.

THREE PHASES OF TRAINING

The Academy program lasts from four to five years, with cadets progressing logically from one year of study to the next. The overall training, however, is divided into three phases, which the Klingons call *Prime Learning*, *Skill Mastery*, and *Skill Application*.

Prime Learning is the first. It is equivalent to Star Fleet Academy's Core Curriculum, and it will take the cadet two years to complete. These studies are the most intense schooling that a Klingon will ever get.

Skill Mastery is the second stage, and teaches the Klingon cadet the skills that he will need to master his specialized training. Skill Mastery may take from two to three years to complete, depending on the cadet's specialty. Once he has completed Skill Mastery, the cadet officially enters either the Imperial Navy or the Imperial Marines.

The final stage, *Skill Application*, is the equivalent of Star Fleet Academy's cadet cruise. Skill Application requires at least one year of the student's time, during which he will actually have a rank in the Imperial Navy or Marines.

Prime Learning

The Prime Learning phase covers the first two years of the cadet's training. During this time, he undertakes a life of strict discipline and complete indoctrination in the skills and abilities that the High Command deems essential to an Imperial Marine or Naval officer. If successful, the character automatically receives the skills (and skill ratings) listed in the Prime Learning Skills Table.

PRIME LEARNING SKILLS TABLE

Administration	10
Computer Operation	10
Interrogation	10
Languages	40
	(at least 30 in Galacta)
Leadership	10
Marksmanship, Modern	30
Personal Combat, Armed	20
	(in weapon of choice)
Personal Combat, Unarmed	20
Social Sciences, Klingon Culture/History	10
Social Sciences, Klingon Law	10
Space Sciences, Astronomy	10
Sports, Swimming	5

Galacta is the Federation standard language and is similar in structure and content to 20th-century Terran English. All Klingon Naval and Marine personnel have a working knowledge of this language, although they seldom choose to use it. All Klingon characters are assumed to have a Skill Rating of 99 in their native *Klingonaase*.

In addition to these automatic skills, a Klingon character may make four additional rolls on 1D10 in any skill he already has. He may also roll more than once to further beef up one of his existing skill ratings.

At the age of twelve, Kevinn enters Prime Learning at the Imperial Star Academy. He receives all the skills from the Prime Learning Skills Table. Of these, he decides to take all 40 *Language Skill Rating* points in Galacta. For his *Personal Combat*, *Armed* skill, Kevinn chooses to learn knife-fighting techniques.

For his four skill rolls, he rolls a 6 to improve his *Computer Operation* skill, rolls a 10 in *Gaming* skill (1 roll, 10), and rolls twice in *Marksmanship, Modern* (a 5 and a 3).

Skill Mastery

After graduating from Prime Learning, the officer candidate enters Skill Mastery. At this point, the Training and Evaluation staff evaluates each student and then assigns him to the program for which he seems best suited. Actually, these assignments depend as much on the Empire's current needs as the results of the evaluation tests.

At this time, the student's name changes to reflect his new status as a Marine or Naval officer. The names of Marine personnel always begin with the letter *M*, while those of Navy personnel always begin with the letter *K*. Thus, a character with the given name Tarth would change his name to Karth if he entered the Navy, or Marth if he entered the Marines.

The cadet's specialty areas will depend upon which branch of the service he enters. Some specialties are common to both branches, while others may be specific to one branch or the other.

BRANCH SPECIALTIES TABLE

Naval Specialties	Marine Specialties
—	Combat Operations
—	Combat Engineering
Communications	Communications
Medical	Medical
Navigation/Helm	—
Sciences	—
Ship's Engineering	—
Security	Security
Weapons/Defense	—

NOTE: When selecting the character's specialty, gender will be a factor. Though women may serve in the Navy or Marines, they may never rise higher than department-head status. Women may not serve in any command position (First Officer or higher), and in combat, they may only serve in support positions. Thus, the only specialties open to females are Communications, Medical, Navigation/Helm, and Sciences.

Specialty Definitions

Combat Operations includes all the fighting forces of the Klingon Empire. These are the Imperial Marines, although other specialties also may be members of the Marine branch. They may be permanently stationed aboard a starship or planetside. Aboard a ship, the Combat Operations Department Head is in charge of all Marines, and is *always* a Marine himself. Control of a ship's troop complement is vitally important to the officers, and so the Combat Operations Department Head is in a position to play the Security Department against the other departments (and perhaps against the Captain) if he commands the loyalty of his forces.

Combat Engineering is the main support specialty of the Imperial Marines. These are the people who service all Marine equipment and vehicles (and may drive them as well). In addition, they are the ones who build any required ground facilities, emplacements, bridges, or any other structures needed in a military situation. (It should be noted that almost any crisis situation off the major Klingon worlds is considered a military situation.)

The *Communications* specialty covers the more menial tasks either aboard Klingon ships or in ground-based situations. These include food preparation and minor fabrication (major fabrication work involving machinery and metal, wood, or plastic crafting is usually handled by either *Ship's Engineering* or *Combat Engineering*). All Communications Officers should have a working knowledge of either Galacta or Romulan languages, although they may conceal this knowledge to gain advantage in an alien-contact situation. Communications personnel who are fluent in *both* languages are much less likely than their less knowledgeable companions to draw menial assignments, and will usually be sent to larger ships closer to the borders. The *Communications* specialty is a favored position for female officers, because a position on the bridge makes it more prestigious than either *Medical* or *Sciences*.

The *Medical* specialty is not quite as important among Klingons as it is in the Federation. Klingon doctors rank with other technicians and engineers whose job it is to repair damaged Imperial property. Medical personnel have no chance of winning a command position in the Klingon Empire.

Navigation/Helm is a combined position in the Klingon Empire. Few ships split the position, as the officer is considered to be in charge of "making the ship move". (An interesting note is that the *Klingonaase* term for Navigator/Helmsman translates literally to "One Who Moves Vehicles").

Science is one of the least prized departments in the Klingon Empire. Imperial Command knows that scientists are a much-needed position, but it nevertheless remains very specialized and less politically powerful than any other. Like medical personnel, no science position can ever lead to command.

Ship's Engineering is similar to its analog aboard Federation ships. The Ship's Engineer must maintain and repair the ship's equipment, as well as operate the transporters. The Klingons would never leave this very important job to any but the most trustworthy individuals. After all, having one's molecules scrambled by a transporter is a very messy way to die.

The *Security* specialty is one of the most important and political departments within the Imperial Navy or Marines. Imperial Klingon Security is a kind of secret police, reminiscent of the Gestapo of Nazi Germany on 20th-century Terra. Security's primary concerns are interrogation, internal security, and surveillance. Guard duties and 'muscle' operations are left to the Combat Operations personnel, with guidance from Security.

Though nominally under the ship Captain's command, the Security Department is the eyes and ears of the Empire, which often gives a ship's Chief of Security more actual clout than the Captain. For the sake of balance, Security personnel can never be assigned command of a ship, except when an Imperial Security operative must temporarily seize command in the name of the Emperor. Such command opportunities would never be made permanent, however.

Weapons/Defense is a separate specialty in the Imperial Navy. Although important only in times of battle, this is the most sought-after position on a ship, rivalled only by Combat Operations and Ship's Security. Weapons/Defense is a good specialty from which to graduate to a captaincy.

As stated earlier, Kevinn will climb the naval ladder within the Navigation/Helm specialty. It is for this reason that we named him with a *K*, for the Imperial Navy.

SPECIALTY SKILLS

Once the character's specialty is chosen, the player will consult the appropriate Skill Table for the Skill Ratings to be added to any he already has. The time required for the student to learn a skill varies with the specialty chosen. Each Skill Table lists how long it takes to master the skill.

COMBAT OPERATIONS SKILL TABLE

3 years

Environmental Suit Operations	20
Interrogation	10
Leadership	10
Marksmanship, Archaic (any weapon)	10
Marksmanship, Modern	30
Personal Combat, Armed (any weapon)	10
Personal Combat, Unarmed	30
Personal Weapons Technology	10
Planetary Survival (any types)	20
Small Unit Tactics	20
Streetwise	20
Vehicle Operation, Ground Vehicle	5
Zero-G Operations	30



COMBAT ENGINEERING SKILL TABLE

3 years

Communication Systems Technology	10
Demolitions	10
Electronics Technology	10
Environmental Suit Operation	10
Marksmanship, Modern	10
Mechanical Engineering	20
Personal Combat, Unarmed	10
Personal Weapons Technology	20
Security Procedures	10
Small Equipment Systems Operation	10
Small Equipment Systems Technology	10
Surveillance	10
Transporter Operation Procedures	10
Transporter Systems Technology	10
Vehicle Operation, Ground Vehicle	20
Zero-G Operations	10
Specialties	30

(Any Engineering specialties above may be chosen, and the skill rating points spread among them.)

COMMUNICATIONS SKILL TABLE

2 years

Communication Systems Operation	40
Computer Operation	10
Damage Control Procedures	30
Language (Galacta)	20
Language (other)	20
Starship Sensors	20
Transporter Operation Procedures	10

MEDICAL SKILL TABLE

2 years

Environmental Suit Operation	10
Interrogation	20
Life Sciences, Zoology	10
Life Support Systems Technology	10
Medical Sciences, General Medicine (Klingon)	40
Medical Sciences, Psychology (Klingon)	10
Medical Sciences, any other	20
Security Procedures	10
Starship Sensors	20

NAVIGATION/HELM SKILL TABLE

2 years

Computer Operation	10
Space Sciences, Astrogation	40
Space Sciences, Astronomy	10
Space Sciences, Astrophysics	10
Starship Helm Operation	40
Starship Sensors	20
Warp Drive Technology	20

SCIENCES SKILL TABLE

2 years

Computer Operation	10
Environmental Suit Operation	10
Small Equipment Systems Operation	10
Space Sciences, Astronomy	10
Space Sciences, Astrophysics	10
Starship Sensors	20
Any other Science Skills	80

(Any science skill may be chosen from *Life Sciences*, *Physical Sciences*, and *Planetary Sciences*. At least two must have Skill Ratings of 10 or higher.

SHIP'S ENGINEERING SKILL TABLE

3 years

Computer Technology	10
Deflector Shield Technology	10
Electronics Technology	10
Environmental Suit Operation	10
Life Support Systems Technology	10
Mechanical Engineering	10
Personal Weapons Technology	10
Physical Sciences, Physics	10
Shuttlecraft Systems Technology	5
Small Equipment Systems Operation	5
Small Equipment Systems Technology	5
Space Sciences, Astronautics	30
Starship Sensors	10
Starship Weaponry Technology	10
Transporter Operation Procedures	10
Transporter Systems Technology	10
Warp Drive Technology	10
Zero-G Operations	10
Specialties	40

(Any Engineering specialties above may be chosen, and the skill rating points spread among them.

SECURITY SKILL TABLE

3 years

Bribery	10
Interrogation	30
Marksmanship, Modern	20
Medical Sciences, Psychology (Klingon)	10
Negotiation/Diplomacy	15
Personal Combat, Unarmed	20
Personal Weapons Technology	10
Security Procedures	30
Shuttlecraft Pilot	10
Small Unit Tactics	20
Social Sciences, Federation Law	10
Social Sciences, Klingon Law	10
Surveillance	20
Zero-G Operations	10

WEAPONS/DEFENSE SKILL TABLE

2 years

Computer Operation	10
Deflector Shield Technology	40
Starship Combat Strategy/Tactics	20
Starship Sensors	20
Starship Weaponry Operation	40
Transporter Operation Procedures	20

Outside Electives

In addition to his Specialty Skills, a character may gain an additional two skills for every year it takes to achieve Skill Mastery. Thus, a character who enters the Medical specialty (two years) gains four skills, while a Security specialist (three years) gains six. These may be new skills, skills the character already has and wishes to improve, or a combination of the two. For each skill chosen, roll 1D10 and add the result to the appropriate Skill Rating.

Because Kevinn entered the Navigation/Helm specialty, he gains a total of four elective skills. He decides that he would like to learn how to pilot a shuttlecraft, and spends two of his rolls on *Shuttlecraft Pilot* (7 and 10). He also decides to learn a little about the fine art of *Bribery* (8). Finally, he decides to improve his skill in *Galacta*, and so adds 9 points to his *Language, Galacta* Skill Rating of 40.

Advanced Training

For every year in Skill Mastery, the character now receives three skill rolls in any skill he already has. In addition, highly intelligent characters (INT score 60 or higher) receive one extra skill roll for every 10 points above 50. Five of these may be taken in any of his existing skill areas, but the rest must be from the character's Specialty Skill List. To find the number of skill rolls available, multiply the number of years in Skill Mastery by 3. Subtract 50 from the character's INT score, and divide the resulting number by 10 (round down). Add these two numbers together.

Because Kevinn entered the Navigator/Helm specialty, he spent two years in Skill Mastery. We multiply 2 times 3, which gives him another six skill rolls. His INT score is 61, which gives him still another skill roll besides those six ($61 - 50 = 11$, $11/10 = 1.1$, rounding down to 1). Thus, Kevinn gains a total of seven skill rolls. Five of these may be in any of the skills he already has, but at least two must be from his specialty.

Kevinn decides to improve his *Bribery* skill (8), his *Interrogation* skill (6), his *Shuttlecraft Pilot* skill (6), his *Personal Combat, Unarmed* skill (8), his *Marksmanship, Modern* skill (2), his *Space Sciences, Astrogation* skill (4), and his *Starship Helm Operation* skill (8). Notice that at least two of these skills are from his specialty list (the last two).

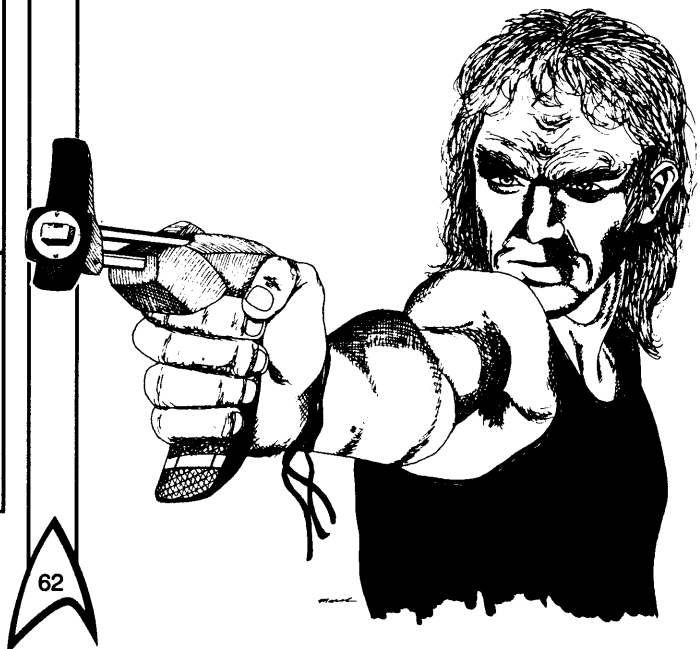

SKILL APPLICATION

After completing Skill Mastery, the cadet embarks upon one year of on-the-job training, which is roughly equivalent to the Star Fleet Cadet Cruise. At this stage, the cadet is given the rank of Midshipman. During this time, his superiors and Imperial Security are both carefully monitoring his performance. Their reports become a part of the Midshipman's record, and are also forwarded to the Imperial Star Academy for evaluation.

A Midshipman must often spend more than one year in Skill Application. This might be due to poor performance, or because Security found that some of his remarks or actions in that year were unbecoming to an officer. In such cases, the offending remark or action is noted in the Midshipman's record, and may haunt the student for the rest of his career.

From this stage onward, a character may attempt *Bribery* to alter the results of his Assignment Rolls and Cruise Results die rolls. For example, if the cadet is unhappy with his Skill Application assignment, he may try to bribe the officials to change it. A successful roll against the cadet's *Bribery* Skill Rating will shift the assignment up one level, and will add 5 points to his *Bribery* Skill Rating. If the roll fails, the assignment shifts down at least one step, and the cadet may suffer even more severe penalties. (This is up to the gamemaster, who will be the judge of how much or how little harshness the situation warrants.) Characters with low *Bribery* Skill Ratings would do best not to attempt to use the skill until they can raise the rating. Of course, even a failed *Bribery* roll will raise the *Bribery* Skill Rating by 2 points, but the slightly higher rating may not help much in the brig (or walking in space without a suit)!

To find the Skill Application assignment, roll percentile dice (D100) against the following table, applying die modifiers as applicable.

SKILL APPLICATION CRUISE ASSIGNMENT

Die Roll	Result
25 or less	Imperial Klingon Expeditionary Forces
26-40	Imperial Navy or Marines
41-65	Sector Naval Garrison or Marine Outpost
66-80	Exploration/Colonization Fleet
81 or more	Merchant/Courier Fleet

Die Modifiers

Character is member of Imperial Race	-20
LUC 40 or more	-10
LUC 35-39	-5
LUC 20 or less	+5
INT 70 or more	-10
INT 60-69	-5
Failed to pass last Skill Assignment	+10
Each negative Security Notation	+2
Each positive Security Notation	-2

For every year spent in Skill Application, the Midshipman must make a Saving Roll against his *CHA* score. A successful roll means that Security gives the character a positive mark, indicated by a plus sign in the Security Notation box of the **Klingon Character Data Record** for that cruise. If the character misses the roll by less than 10, Security gives no mark, but is suspicious and may be watching him more closely. A Saving Roll that misses by more than 10 points indicates that Security has put a negative mark on the student's record. Write a negative sign in the appropriate box.

A negative security mark will follow the character for a long time. For each negative mark from Security, apply a 5-point penalty to every roll the character makes against his *Administration* or *Bribery* Skill Ratings, or against his *CHA* score when dealing with the Klingon government or superior officers. Each positive mark cancels one existing negative mark, giving a bonus of 5 points to any of the above die rolls.

At the end of the Skill Application year, the student learns whether or not he passed by making a die roll similar to his earlier Cruise Assignment Roll. He rolls percentile dice and applies any modifiers from the Cruise Result Table.

CRUISE RESULT TABLE

Die Roll	Result
5 or less	Passed with Imperial Commendation (see below)
6-15	Passed with Honors (see below)
16-60	Passed
61 or more	Failed. Repeat Skill Application.

Die Modifiers

Imperial Klingon Expeditionary Forces	-20
Imperial Navy or Marines	-15
Sector Naval Garrison or Marine Outpost	-10
Exploration/Colonization Fleet	+10
Merchant/Courier Fleet	+20
LUC 40 or more	-10
LUC 35-39	-5
LUC 20 or less	+5
Second or later cruise	+10
For each negative Security Notation	+5
For each positive Security Notation	-5

The Midshipman *may* attempt to bribe his way through the Skill Application program. A successful roll against his *Bribery* Skill Rating results in his automatically passing the cruise, and raises his *Bribery* Skill Rating by 5 points. This brings no chance for special commendations or honors, however. If the attempt fails, the Midshipman automatically fails the Skill Application cruise, and automatically receives a negative security mark. The character may make this *Bribery* attempt as an alternate to the normal Cruise Result Roll, but he may attempt only one or the other for each Skill Application cruise. As before, even a failed bribery attempt adds 2 points to the character's *Bribery* Skill Rating. (Learning is fast when so much is at stake!)

If the Midshipman passes with an Imperial Commendation, he graduates, with an immediate promotion to Lieutenant j.g., and he receives a bonus of 20 points to his first Post-Academy Assignment Roll. Graduating with Honors does not give the automatic promotion, but a bonus of 10 points may be applied to the first Post-Academy Assignment Roll.

For each year spent in Skill Application, the student receives five skill rolls. He must choose at least three of these from his specialty (see the Skill Mastery specialty lists). The other two may be for new skills or may be used to raise old skills. Each skill roll adds 1D10 to the skill rating.

When the Midshipman graduates from the Skill Application stage, he is automatically promoted to the rank of Ensign, unless awarded an Imperial Commendation (see above).

If the Midshipman fails the Cruise Results roll, he must start again with the Skill Application Cruise Assignment roll and repeat the whole process up through this point.

Kevinn is nearing the end of his training. His *Bribery Skill Rating* is not high (16), and so he decides not to try to bribe his way through the Skill Application stage. He must make a Cruise Assignment Roll to determine where he will serve his first cruise. Adding his die modifiers, he finds that his *Luc* score of 58 gives a -10 point bonus, his *INT* score of 61 gives a -5, and being a member of the Imperial Race gives him another -20 points. His final modifier is -35. He rolls percentile dice, with a result of 54. Subtracting 35 from 54 to get 19, he is assigned to the Imperial Klingon Expeditionary Forces—an excellent outcome!

The next step is his Security notation. Though Kevinn's *CHA* is not very high (49), he has not attracted unfavorable notice this year (die roll of 6), and so he gains a positive notation. Note that this would give a -5 die modifier to any *Bribery Skill Roll* he attempts.

Finally, Kevinn must find out whether or not he passed his Skill Application assignment. His modifiers are -20 for Imperial Klingon Expeditionary Forces, -10 for a *Luc* score of 58, and -5 for his positive Security Notation, for a total die modifier of -35. Again, a modifier like that, combined with his low *Bribery Skill Rating*, makes Kevinn decide to make the normal roll instead of attempting to bribe the officials. He rolls a 79 (which would normally mean failure), but the modifier adjusts the result to 44, which easily passes him. Kevinn graduates from the Imperial Star Academy as an Ensign.

For his skill rolls, Kevinn gains three skills in his specialty area and any other two of his choice. He chooses to improve his *Space Sciences*, *Astrogation* (8), *Space Sciences*, *Astronomy* (9), *Starship Helm Operation* (10), and *Shuttlecraft Pilot* (2 and 5).

ADVANCED TRAINING

No matter how rigorous the program, the Imperial Star Academy provides only the basic officer training. The Klingon officer who hopes to command a starship or head a department needs advanced training. The two sections of advanced training are known as *Leaders of Men* and *Leaders of Vessels*.

The Leaders of Men training corresponds to Department Head School in Star Fleet. The one-year course teaches officers to deal with the people and problems within a single department aboard a starship. The Leaders of Men positions include Chief Communications Officer, Chief Medical Officer, Chief Navigator/Helmsman, Chief Science Officer, Chief Engineer, Chief of Security, and Chief Weapons/Defense Officer. Commanding officers of Imperial Marine battalions must also enter the Leaders of Men school.

The *Leaders of Vessels* training teaches the officer how to command a starship. It builds upon the leadership skills taught in Leaders of Men, and also teaches the tactics and strategies used by fighting vessels of the Imperial Navy. Starship Captains and First Officers must train in the Leaders of Vessels school.

LEADERS OF MEN

As in most other stages of learning, Leaders of Men consists of a core curriculum and elective courses. The core curriculum gives or improves the following skills and Skill Ratings:

LEADERS OF MEN CURRICULUM TABLE

Administration	25
Interrogation	20
Leadership	20
Security Procedures	10

In addition to the above skills, the character may improve any skill previously acquired. To find the number of skills he may advance, divide the *INT* score by 10 and round down. The player rolls 1D10 to determine how much each skill increases, and may roll twice for the same skill.

Officers who graduate from Leaders of Men are promoted one rank.

In our example, Kevinn has entered Leaders of Men school. He adds the skills given in the Curriculum Table above to the skill ratings on his *Klingon Character Data Record*. Because his *INT* score is 61, he can improve 6 skills ($61/10 = 6.1$, rounded down to 6). He decides to improve his *Language*, *Galacta Skill Rating* (4), *Bribery* (7 and 8), *General Medicine*, *Klingon* (7 and 7), and *Space Sciences*, *Astrogation* (6).

LEADERS OF VESSELS

The Leaders of Vessels course also requires one year. Again, a core curriculum shows the skills and skill ratings he gains.

LEADERS OF VESSELS CURRICULUM TABLE

Leadership	10
Social Sciences, Federation Law	10
Social Sciences, Klingon Law	10
Starship Combat Strategy/Tactics	30

In addition, the character may improve a number of skills previously acquired. To find how many skills he may advance, divide the character's *INT* score by 10 and round down. As always, each skill may be improved by 1D10, and any skill may be chosen more than once.

Graduates of Leaders of Vessels school are automatically promoted one rank.

Kevinn's superiors intend that he will one day captain a ship, and so he must take Leaders of Vessels training. He adds the skills from its core curriculum, and may also improve six more skills because his *INT* score is 61 ($61/10 = 6.1$, rounded down to 6). He decides to improve *Bribery* (8), *Marksmanship*, *Modern* (6), *Federation Law* (6 and 8), and *Starship Combat Strategy/Tactics* (6 and 4).

SERVICE EXPERIENCE

As with Post-Academy Experience in the Federation, Klingon Service Experience determines how many years a character has spent in service before entering the campaign. Generally speaking, a character who starts a campaign with a higher rank or position is usually more experienced and older than an officer in a less lofty post. There are exceptions to the rule because luck and/or intelligence can speed an individual's rise through the ranks. Klingon officer characters tend to rise through the ranks faster than their Federation counterparts (and fall, just as fast, if they are not careful...). This is just as well, because Klingons have a shorter lifespan than do Humans, and so suffer aging effects sooner.

As the players and gamemaster have already decided what position and rank the characters hold in the game, it now remains only to determine how long they have served and what skills they advanced while in active service. Rolling dice against the various tables given below is how the players create this background.

Players and gamemasters are encouraged to elaborate freely on this background information as much as possible, adding details to flesh out the character for more realistic roleplaying. Perhaps a character who has been in a 'nowhere' job for a year or two is suddenly assigned to the Imperial Klingon Expeditionary Forces. It may be that the character has unexpectedly distinguished himself in some manner to rate the choice new assignment. On the other hand, a well-placed officer who is suddenly assigned to a merchant/courier ship may have aroused the suspicions of a superior officer, who decided to get him out of the way with a transfer to a less strategic post. Filling in such details helps bring the characters alive, making them much more fun to play.

TOURS OF DUTY SERVED

To determine the total number of tours of duty his character has served, each player rolls 1D10, subtracts 1, and divides by 2. The resulting number is rounded down, with a minimum of 1 allowed. Then, he adds or subtracts the following modifiers to get the total number of postings. As the Tour of Duty Modifiers Table shows, luck and intelligence reduce the number of tours, but characters destined for higher ranks or positions will serve more tours.

TOUR OF DUTY MODIFIERS

For Attributes

INT 60 or more	-1 tour
LUC 40 or more	-1 tour
LUC 20 or less	+1 tour

For Destined Rank

Ensign	-1 tour
Lieutenant jg or Lt.	No Modifier
Lt. Commander or Cmdr.	+1 tour
Captain	+2 tours
Admiral or above	+3 tours

For Destined Position, Cumulative

Captain or First Officer	+2 tours
Department Head	+1 tour
Imperial Klingon Expeditionary Forces	+1 tour

Our character, Kevinn, is almost finished with his training. Rolling 5 on 1D10, we subtract 1 and divide by 2 to find that Kevinn will serve two tours of duty ($5 - 1 = 4$, $4/2 = 2$). We then consult the Tour of Duty Modifiers Table. Kevinn's INT of 61 = -1 tour, his LUC of 58 = -1 tour, his Rank of Captain = +2 tours, and his position as Captain of Ship = +2 tours, for a total of +2. Adding these to the two tours rolled initially, we find Kevinn's total number of tours is four.

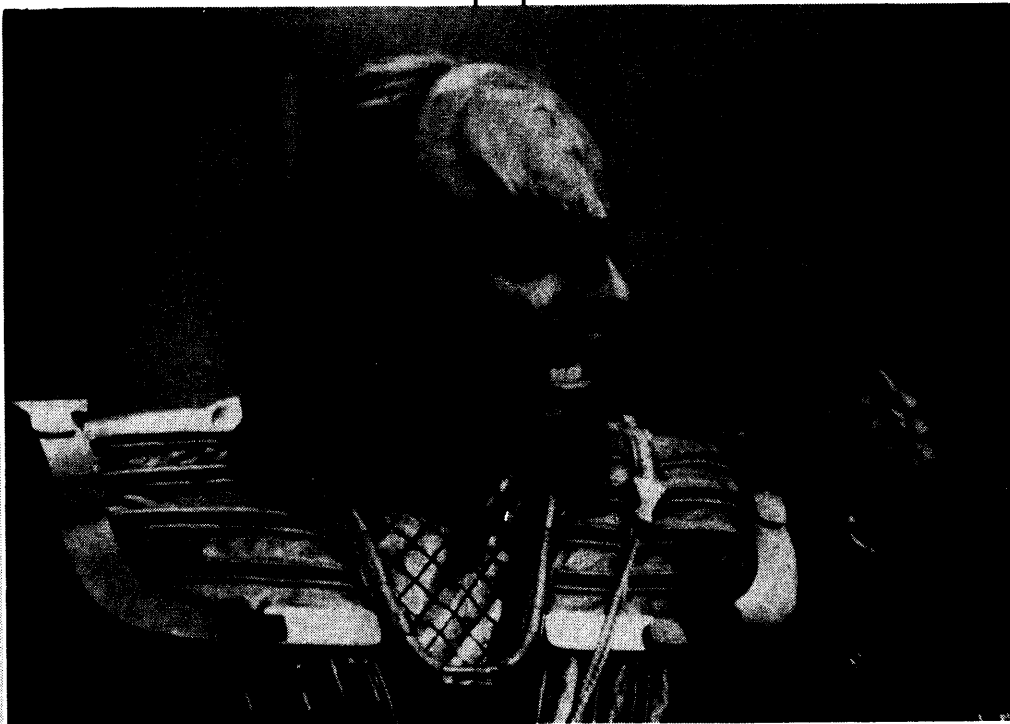

TOUR ASSIGNMENT AND LENGTH

A tour of service in the Klingon Navy or Marines is one to four years long. The High Command keeps Klingon officers moving around quite a bit, partly to give them a variety of experience and partly to prevent anyone from developing his own strong organization. For each tour served, the player rolls dice against the Tour Assignment Table to determine his character's assignment and tour length. As the modifiers to the table show, luck, intelligence, and a clean Security record play their part in where the character gets posted.

TOUR ASSIGNMENT TABLE	
Die Roll	Result
10 or less	Imperial Klingon Expeditionary Forces
11-30	Imperial Navy or Marines
31-50	Sector Naval Garrison or Marine Outpost
51-70	Exploration/Colonization Fleet
71-80	Merchant/Courier Fleet
81-90	Imperial Star Fortress Duty
91 or more	Imperial Naval Academy

Tour Assignment Modifiers	
INT 70 or more	-10
INT 60-69	-5
LUC 40 or more	-10
LUC 20 or less	+5
Each negative Security Notation	+5
Each positive Security Notation	-5
First Tour Only	
Graduated with Imperial Commendation	-20
Graduated with Honors	-10

Having rolled for each tour assignment, the player now makes die rolls to determine the length of each. For each tour, roll 1D10, subtract 1, and divide by 2. Round down the result, with a minimum tour length of one year.

Finally, to create the character's Security Notation for each tour, make a Saving Roll (1D100) against the character's CHA score, then apply the modifiers from the Security Notation Modifiers Table.

SECURITY NOTATION MODIFIERS	
INT 65 or more	-10
INT 40 or less	+10
LUC 40 or more	-10
LUC 20 or less	+10
Each previous negative Security Notation	+2
Each previous positive Security Notation	-2
For every 10 points of <i>Security Procedures</i> Skill	-5

As before, if the roll is successful, the character receives a positive Security Notation. If the roll fails by 10 or less, there is no Notation. Missing the roll by more than 10 gives him a negative Security Notation.

For his first tour, Kevinn rolls 52. Totalling up his modifiers (INT of 61 = -5, LUC of 58 = -10, one positive Security Notation = -5) gives him a -20. Subtracting 20 from 52 gives a modified Tour Roll of 32, which places him in the Sector Naval Garrison. He then rolls 8 on 1D10 for length of tour, which is modified to 3 years ($8 - 1 = 7$, $7/2 = 3.5$, rounded down to 3 years). For his first Security Notation, he rolls 1D100 against his CHA score, with a result of 46. Totalling up his Security Notation Modifiers (LUC of 58 = -10, one positive Security Notation = -2, and a *Security Procedures* Skill Rating of 10 = -5) gives him a -17. Subtracting 17 from 46 gives him 29, which is well under his CHA of 49. Kevinn therefore has a positive Security Notation for his first tour.

The results of each of his other tours are as follows:

- 2nd tour—Sector Naval Garrison, 2 years, negative Security Notation
- 3rd tour—Imperial Expeditionary Forces, 4 years, positive Security Notation
- 4th tour—Imperial Navy, 4 years, positive Security Notation

SERVICE SKILL ROLLS

Once the character leaves the Imperial Academy, he continues to learn new skills and to improve on known ones. For every two years of total service, the character may improve one skill. See the Service Skill Modifiers Table to find whether an officer's attributes or experience earn him any bonus skill rolls.

Add up the number of years of service and divide by 2 (rounding down) to determine the total number of skills that the character may improve, plus any bonuses from the modifiers table. The character may choose from previously learned skills OR he may also choose any skill in the skill list. Each skill may be improved by 1D10 points, and any skill may be chosen more than once.

SERVICE SKILL MODIFIERS	
INT 70 or more	2 extra rolls
INT 60-69	1 extra roll
LUC 40 or more	1 extra roll
Per 2 years served in	
Imperial Klingon Expeditionary Forces	1 extra roll
Per year of Imperial Star Fortress Duty	1 extra roll
	on <i>Streetwise</i> or <i>Gaming</i>
Per additional Cadet Cruise beyond first	1 extra roll
	on <i>Streetwise</i> , <i>Gaming</i> , or <i>Carousing</i>

The final number of years that Kevinn has served is 13, which gives him six skill advancements ($13/2 = 6.5$, rounded down to 6). Kevinn's INT of 61 gives him one extra roll, his LUC of 58 gives him one extra roll, and his four years in the Expeditionary Forces give him two extra rolls, for a total of ten skill advancements. He chooses the following skills: *Bribery* (3), *Interrogation* (3), *Language, Galacta* (8), *Marksmanship, Modern* (8), *Personal Combat, Unarmed* (4 and 6), *Security Procedures* (8), *Shuttlecraft Pilot* (5), and *Starship Combat Strategy/Tactics* (2 and 8).

COMBAT STATISTICS

The player must now create several combat statistics in order to use his character in combat. These numbers tell how many combat actions the character may make in a given turn, how easy it is for him to hit his target with modern weaponry, how easy it is to hit his opponent in hand-to-hand combat, and how much damage he does with each punch. (See also the **Tactical Movement And Combat** section of the STRPG2 rules.

ACTION POINTS (AP)

To find a Klingon character's AP, use the STRPG2 formula of dividing his DEX score by 10, rounding down, and adding 4. Circle this number in the Action Point Track on the right-hand side of the **Klingon Character Data Record**.

In our example, Kevinn has a DEX score of 63, which gives him 10 AP ($63/10 = 6.3$, rounded down to 6; $6 + 4 = 10$).

BASE TO-HIT NUMBERS

Each player must calculate at least two Base To-Hit numbers (*To-Hit, Modern* and the *To-Hit, HTH*) for his character. The formula is the average of the character's DEX score and the appropriate Skill Rating, rounded up. For the *To-Hit, Modern*, use the character's rating in *Marksmanship, Modern*. For the *To-Hit, HTH*, use his rating in *Personal Combat, Unarmed*. Calculate any other To-Hit number in the same fashion by averaging the character's DEX score with his Skill Rating in either *Marksmanship* skill or a *Personal Combat* skill. Record these numbers in the appropriate spaces of the **Klingon Character Data Record**.

Kevinn has a DEX score of 63, and a Skill Rating of 63 in *Marksmanship, Modern*. His *Base To-Hit, Modern* is 63 ($63 + 63 = 126$, $126/2 = 63$). His *Base To-Hit, HTH* is 53, and his *Base To-Hit, Knife* is 41.



BARE-HAND DAMAGE

The damage a Klingon character can do in unarmed (HTH) personal combat is determined according to the STRPG2 rules, but the table is reproduced here for convenience. First, find the damage the character can give due to his STR score, and then add the bonus for his Skill Rating in *Personal Combat, Unarmed*. Record the Bare-Hand Damage number on the **Klingon Character Data Record**.

BARE-HAND DAMAGE DUE TO STRENGTH

STR Score	Damage
01-25	1D10 - 3
26-50	1D10
51-75	1D10 + 3
76-100	2D10
101-125	2D10 + 3
126-150	3D10
151-175	3D10 + 3

Modifier For Skill

Add 1 damage point for each 10 full points in *Personal Combat, Unarmed*.

In our example, Kevinn has a STR score of 62, which gives him a base Bare-Hand Damage of 1D10 + 3 damage points. His *Personal Combat, Unarmed* Skill Rating of 43 gives him a modifier of +4, for a final Bare-Hand Damage score of 1D10 + 7.

CHARACTER AGE

To find the character's age, the player simply totals all the years served in the various stages of the character's development, and adds that result to 12, which is the age a Klingon enters the Imperial Star Academy. Prime Learning takes two years, Skill Mastery takes two or three more, and Skill Application takes one year per cruise. In advanced training, both Leaders of Men and Leaders of Vessels schools require one year each.

Remember that Klingon characters have a shorter life span than Humans, and will reach critical age earlier (Imperial Klingons 40, Klingon/Human Fusions 45, and Klingon/Romulan Fusions 60. See the STRPG2 rules for more on critical aging.)

To find Kevinn's age as the campaign begins, we total up his years of training and service:

Prime Learning	2 years
Skill Mastery	2 years
Skill Application	1 year
Leaders of Men school	1 year
Leaders of Vessels school	1 year
1st tour of duty	3 years
2nd tour of duty	2 years
3rd tour of duty	4 years
4th tour of duty	4 years

The total (20) is added to 12 (the age of entry) for a final age of 32. Though 32 would be young for a Human Captain, it is about the right age for a Klingon. Kevinn has eight years before reaching the Imperial Klingon's critical age.

GAMEMASTERING KLINGON ADVENTURES

HINTS FOR PLAY

Some gamemasters might imagine that running a Klingon campaign would be less complicated and less structured than is a Star Fleet campaign. After all, the Klingons, with their hunger for power, glory, status, and domination, sometimes sound like characters out of the lawless Old West, with every man for himself. Yet, the exact opposite is usually the case, with Klingon campaigns requiring more skillful gamemastering than any other.

For example, Klingon starship Captains are not beserk killers, interested in destruction of any ship they encounter. They fight for their own good motives and reasons. If they seem a bit trigger-happy sometimes, it is because the only way they can advance in rank and status is to win victories. A Klingon commander also has obligations to superior authority that he must carefully consider before entering battle.

When helping players to create characters, remind them that Klingons should be as three-dimensional as Star Fleet characters. Every Klingon has his own blend of hopes, fears, likes, dislikes, family, friends, ambitions, and quirks, no matter how dedicated he may be to the Empire. Though too much eccentricity would be tolerated only in the most efficient and valuable officers, there is still plenty of room for individuality.

The Klingon philosophy involving combat encounters is, however, much different than that of the Federation. Because Klingons are so conscious of personal power and prestige, they see that one way to achieve these is by winning substantial victories in space against the Empire's enemies.

The possibilities for twists on familiar *STAR TREK* plotlines are endless. How would the Klingons have handled Korob and Sylvia in "Catspaw", or Trelane, "The Squire of Gothos"? Would they have been resourceful enough to stop "The Doomsday Machine"? FASA publishes a number of adventures featuring Klingons as player characters, though clever gamemasters can also rework existing Star Fleet scenarios for Klingon player groups. Indeed, the gamemaster is free to borrow, mix, match, or to create from scratch his own brand of *STAR TREK* adventure.



GETTING STARTED

As always, the gamemaster first decides on a setting for the campaign, usually a ship of the Imperial Klingon Fleet. The *D-7* cruiser (backbone of the Klingon fleet and the ship most frequently encountered near the UFP) is a popular choice, and has many advantages. Most times, the Klingons deploy *D-7*s in squadrons of three, but single ships are often encountered near the Federation. (Though officially assigned to a three-ship squadron, these single vessels actually spend most of their time on lone patrol.)

For groups of experienced players, a ship such as a *D-11* or *D-18* Destroyer might provide a more challenging campaign setting. As these ships move around a lot to trouble spots, the campaign is likely to be somewhat combat-oriented.

For smaller groups, the gamemaster may find a *K-23* escort to be more suitable. As the name indicates, these vessels accompany convoys and merchant vessels. This can be exciting work, especially in areas of space disputed by the Romulans. Small-crew campaigns also work well with scouts such as the *K-22 Bird of Prey* seen in *STAR TREK III*, which operate on the fringes of explored space or on deep-penetration spy missions into the UFP or Romulan Star Empire. (For complete descriptions and statistics of all known Klingon vessels, see FASA's *Klingon Ship Recognition Manual*.)

STARSHIP ENCOUNTERS

Once the campaign background and a set of well-developed characters is established, the gamemaster can begin to implement his adventure plans and plotlines. Though these may be similar to Star Fleet adventures, Klingons will react very differently to the same situation. An unknown derelict vessel, for example, presents an intriguing mystery to both UFP and Klingon Empire crews, but the UFP group would probably try to assist survivors and then investigate what caused the accident. Klingons, on the other hand, would be interested in salvaging valuable bits of alien technology or looting other items of interest (and in protecting Imperial security by capturing and interrogating survivors).

Klingon crews would also handle a medical emergency call in a different manner. Using the example of an agricultural colony stricken by an unknown virus, Klingons might consider whether to rescue all the colonists or to save only important command personnel, allowing the servitor race who does the actual work to die off. The latter choice might be appealing if it would cripple the fortunes of a rival line that controls the planet. Of course, the Klingon commander would be careful to cover his tracks to avoid retribution from his rivals; he would do his best to make a rescue effort that would pass for sincere before the Imperial Council.

If called upon to undertake a mysterious mission, a Klingon Captain must be very careful. Is the mission all it seems to be? Are his ship and crew being used as part of a power play by an ambitious noble? If so, how can the Captain get his share if the mission is successful, or protect himself if it fails? (And what would it be worth to rival factions to assure the mission's failure?) Of course, the Captain must remember that the whole thing may be a trap set by Imperial Security to check his loyalty.

KLINGON IMPERIAL POLICY

To a Klingon, a substantial victory is one that would impress, and perhaps even overshadow, his superiors. There is little glory in destroying an unarmed vessel, for instance, unless the vessel is a target of strategic importance (such as a critical fuel shipment or courier ship). In fact, attacking without reason or orders might often lead to disciplinary measures against the Klingon Captain and ship involved, if the incident threatened treaties or agreements that the Empire was not yet ready to break.

Klingon Imperial policy does provide for a strong defense of Klingon space, however. A ship of any power that clearly violates that space without authorization is fair game for boarding or destruction. If the offending ship is of any size at all, boarding and capture would be preferred, especially if the vessel belongs to the UFP or the Romulan Star Empire military. Capture intact of any large war vessel would be a prize worth much to a Klingon ship commander. If boarding were not possible, however, the commander would not hesitate to destroy the offending vessel.

In areas of dispute, Imperial policy is less certain. If a Klingon starship captain were to capture or destroy an unfriendly (read: non-Klingon) vessel in such an area, he must act with minimum fuss and attention. There must be no chance that word will reach the ship's home base to inform it of an unprovoked attack. Deciding whether or not to risk such an attack rests solely with the Klingon commander, and his career depends on making the right choice.

In the Organian Treaty Zone, there is no margin for error. Klingon commanders who serve here are under strict orders to risk no behavior that might attract the attention of the powerful but pacifist Organians or that might endanger the treaty. Clandestine operations that occur here (such as the one depicted in "The Trouble with Tribbles") are usually planned at the highest levels, though every now and then, an ambitious line might take an unauthorized risk. A commander who botches such a mission will soon find himself before an Imperial Court, whose members will no doubt suggest he do the Empire a favor by quietly committing suicide. If he does not comply, the Court will appoint someone to help him. Such commanders sometimes prefer to face Federation justice, or even turn pirate and never return to the Empire. The last alternative is dangerous, indeed, because Imperial Security relentlessly hunts down commanders who steal their ships. The renegade could end up with a price on his head in both the UFP and the Empire.

A Klingon commander must even be wary of another ship flying Klingon colors, if he encounters the vessel unexpectedly or if its superior officers are known rivals of his own superiors. In the Empire, no one is ever sure when he is being used as a pawn in the *komerex zha*, the perpetual game. More than one captain has been sacrificed, along with his ship and crew, to gain a small political advantage for a superior officer or a powerful noble.

A Klingon cannot afford to make too many errors or to express unapproved opinions to someone even remotely untrustworthy. After all, every ship of any size is sure to have at least one clandestine agent of Klingon Imperial Security on board. The usual way for a Klingon to get someone's trust is by obtaining a political or professional hold over the other fellow.

Remember that power games within the Empire create constant minor shifts, mostly without warning. The prudent, flexible ship commander will be the most successful, and the longest lived.



THE PARANOIA FACTOR

On most Klingon vessels, the relationship between officers and crew is radically different than on Star Fleet vessels. Klingons tend to move around to many ships, especially as junior officers. This is due both to the ambition of junior officers and to the paranoia of the High Command, who prefer not to let a popular or crafty officer get too much of a toehold in the hierarchy. As the campaign begins, it is unlikely that Klingon player characters will have had time to develop much trust or loyalty among their own crew.

All Klingon officers serve under the shadow of doubt, and this aura of suspicion is crucial to the tone of the campaign. Junior officers are always waiting for chances to supplant their superiors, and will sometimes even plot their downfall. As if danger from downranks were not bad enough, a player character must also watch out for trouble from upranks, where a superior officer may decide that the junior officer is too efficient, popular, or clever, and so arrange an 'accident' to remove him from competition for his own position. Finally, the eyes and ears of Imperial Security are everywhere. A Klingon player character can never be sure that a quiet, unassuming NPC crewman is not secretly monitoring his conversations for Imperial Security.

Of course, monitoring internal security is the task of the Security Officer aboard ship, a very important and powerful job in the Empire. Security Officers tend to be loners, at once disdained and feared by the military types. This officer controls and orders most internal spying, but he may or may not be a player character. If the players are inexperienced or having trouble thinking like Klingons, it may be best to make the Security Officer an NPC. He can be set up in an adversary role to the player-character Captain, questioning everything he does and making sure he toes the line politically.

In campaigns with more experienced characters, however, the Security Officer may be a player character. The adversary relationship may still exist, of course. Unknown to the Security Officer, there may also be other clandestine operatives of Imperial Security around, assigned to observe the Security man himself. If he and the Captain get too chummy, and begin to plan operations not in the interest of the Empire, the clandestine agent may step in or call in other help.

An interesting arrangement for groups of experienced players is for the gamemaster to choose a junior officer from among the player's group to play a clandestine agent of Klingon Imperial Security. Before the campaign starts, the gamemaster secretly informs the player of his status and provides him with two character sheets. The sheet the player uses most of the time shows only his cover identity, while his hidden sheet shows his actual rank and capabilities (usually higher). This becomes especially interesting if the covert agent's player is clever, subtle, and really into his role.

Complications arise when such a player must make a die roll against a skill or attribute that is actually higher than his public role (and public character sheet) would indicate. All rolls are attempted on the publicly known score levels. If the roll fails (but would have succeeded using the character's true capabilities), the player chooses whether or not to reveal his greater abilities. In situations where the roll does not represent a life-or-death situation, the player may protect his cover by simply accepting the 'failure'. Where the roll is important, though, the player may simply say, "I made that roll," and continue play. If another player questions this, the gamemaster simply confirms that the roll is O.K., without further comment. This, of course, risks making the other players suspicious.

It is the gamemaster's job to keep Klingon players nervous about their status, one way or the other. Player characters should learn to keep an eye on their superiors' jobs, watching for chances to advance. Outright assassination of superiors is very rare, except when sanctioned by higher-level officers who will protect the assassin. Of course, it is possible for a high-ranking officer to encourage a subordinate to assassinate his immediate superior, only to double-cross him later by claiming the assassin acted alone. By turning his pawn over to Security, the officer thus kills two birds with one stone!

A safer way for a Klingon to advance is to trap his superior by giving him bad advice or incorrect intelligence. When the superior officer fails an important mission, the lower-ranked man's unfavorable report may get his superior reassigned, demoted, or—in extreme cases only—terminated. Any of these might allow the plotter to move up. He must be careful, however, that his own subordinates do not have the same scheme in mind.

Ranking officers try to protect themselves from such treachery by gathering damaging information on subordinates, information that will be revealed if the ranking officer is double-crossed or mysteriously killed in the line of duty. Sometimes, it is safest to *hold* damaging reports to be used later, if necessary.

The Klingon High Command unofficially encourages such behavior (though, officially, a Klingon can lose his command and his life if underhanded actions come to light when he is in disfavor). After all, it is to the High Command's advantage to keep officers too busy to consider moving in on *them*! Too much infighting makes crews inefficient, however, and so High Command will remove any officer who is too ambitious or too much of a troublemaker.

If it sounds difficult for a gamemaster to keep a good balance of power and paranoia, that's correct! A Klingon-based campaign requires excellent roleplaying and even better gamemastering. The challenge is worth it, in terms of the fun everyone can have with this devious but fascinating race.

THE PLOT THICKENS

Klingons differ radically from their Star Fleet counterparts in their approach to outer-space assignments. Klingons tend to be less concerned with the rights of individuals and cultures when those rights interfere with the demands of the Empire or with attaining personal prestige. The good gamemaster must nevertheless prevent the players from running roughshod over the galaxy, however, by building complications into their assignments.



Of course, the easiest complication to implement is an adventure set in the Organian Treaty Zone. If the players' ship is assigned there, the group cannot solve problems in the usual Klingon fashion (orbital bombardment, Marine occupation forces, torture of citizenry, and so on). Not only must a commander fear Organian action, but he must also fear Imperial intervention! Though the Organians appear to have withdrawn from their strict enforcement of the Treaty, no one knows if or when they might decide to play policemen again. At the moment, the Klingons are still wary, and will punish severely any commander who takes too many chances.

In the Treaty Zone, characters must approach assignments such as first contact, negotiation of alliances and treaties, planetary exploration and exploitation, and so on from a more relaxed military posture. That does not imply that they will emulate Federation policies, but that they must use every legal advantage they can grab, and then create a few 'advantages' without getting caught! This calls for shrewd planning by Klingon commanders (and a watchful eye by gamemasters).

Gamemasters, however, must not frustrate all the sneaky tricks their Klingon players think up. After all, in this campaign, the Klingons are the 'good guys' and so should not lose every time. Besides, if the characters devise a clever plan to carry out their assignment, it deserves to succeed. On the other hand, it is best not to let players gain too much of an advantage, especially in important diplomatic conflicts with the Federation. (Unless, of course, the gamemaster plans to allow the campaign to evolve into a variant *STAR TREK* universe where the Klingons get the upper hand! For those who have a secret desire to move in on Federation space, have fun!)

The best setting for Klingon adventures may be deep within the Empire itself. There, the usual foes are other Klingon factions competing for Imperial concessions and power. Starship Captains and crews often become pawns in such struggles, but a determined *pawn* can cleverly play one faction against another and be promoted to a queen of battle with a powerful faction of his own. A ship commander's long-term goal may be to found his own line and to gain enough Imperial attention and power to become an influential Klingon noble in his own right. Achieving that goal should come only after much clever campaigning, which will no doubt include several setbacks and many dangerous assignments. The best way for a Klingon to accumulate power in the Empire is to establish a reputation that makes others afraid to cross him and eager to do him favors (which he will have to return later). That means an ambitious Klingon must accept dangerous work to gather glory for both the Empire and for himself.

More player characters die in Klingon campaigns than in UFP-based games, and so players may want to roleplay more than one character each. One of these characters (usually the one with higher rank and position) is a primary character, who is 'played' most often. The other should be a junior officer, who may or may not be attached to the same department. Both may be active in the same adventure, and a good player should take advantage of opportunities that arise for either one to increase in status or to acquire glory.

In some cases, a player may roleplay two characters who are friends or even linebrothers. Such characters will watch out for each other to some extent, and may seek revenge if the other is double-crossed. A player may, of course, choose two characters who are completely neutral to one another. On the other hand, some players may enjoy roleplaying two characters whose ambitions and positions put them at odds with one another. The ultimate in roleplaying comes when, to further his own ambitions, one of a player's characters backstabs the other at a critical moment. This situation is best reserved only for experienced roleplayers, who can be counted on to stay in character even when the situation goes against them. Gamemasters should *never* allow a single player to hold two very powerful characters, however, especially if they are natural adversaries, such as a Captain and a Security Officer. That would be too much temptation for even the best players.



JUDGING GROUND ACTION

In general, the STRPG2 rules concerning ground action and combat are sufficient to cover almost any situation that might come up involving combat with Klingons. For the gamemaster's convenience, the few differences between Klingons and Star Fleet Officers are described below.

INJURY, DEATH, AND MEDICAL AID

Because Klingon physiology differs from that of other races, a Klingon will, of course, react differently to certain types of injuries and drugs. Gamemasters may choose to apply only the rules for Injury, Death, and Medical Aid given in STRPG2, or they may also add on the following optional rules. These additions do not affect the basic structure of a Star Fleet-centered campaign, but they will make Klingon characters more realistic. Gamemasters will find these options especially useful when some players are roleplaying Klingons.

Physical Damage

Imperial Race Klingons are more susceptible than Fusions to physical damage from edged weapons and projectile weapons. When an Imperial Race Klingon is hit by an edged blade such as a sword or dagger, add an extra 2 points of damage to wound. Successful attacks with projectile weapons will add an extra 1 point of damage to the wound.

Fusion races are probably less susceptible than Imperials to these types of damage because of the hybrid vigor and strength of the non-Klingon half of the Fusion. Fusions take no more damage from projectiles than do Humans or other non-Klingon races. They do still take a bonus of 1 point to damage from edged weapons.



Stun Damage

Because of differences in physiology, non-Human races vary in stun damage they take. In the case of Klingons, their nervous systems are somehow more immune to stun effects than those of Humans or Vulcans.

KLINGON MEDICAL PHILOSOPHY

The major difference between Klingon and Federation medicine is in their operational philosophies. This difference is summed up by the concept of triage, which is the judgment the physician makes about the order of treatment of severely wounded or ill patients. In the Federation, triage operates on the principle of worst wounded, first treated. Klingon doctors, on the other hand, are more like the technician who must repair a piece of equipment: Is it more cost-effective to repair the item or to scrap and replace it? In other words, if treating a severely wounded soldier would cost more than training his replacement, the doctor would simply allow the soldier to die while he moved on to other patients. If, on the other hand, the patient had invaluable knowledge or skills, Klingons would spare no cost to save his life.

Klingon doctors are also not as concerned about pain, which is why they have fewer mild anesthetics and pain-killers in their kits. Klingons are not averse to using pain-killers when necessary, however. If use of a painblocking agent will put an otherwise incapacitated man back on the job, a Klingon doctor will not hesitate to administer the medication. Minor surgery (such as dental surgery, removal of projectiles, and suturing of minor wounds) is usually performed with no anesthetic at all, however. Klingon doctors do use anesthesia for major surgery.

Likewise, Klingons do not worry so much about how the repair looks as they do about how well it functions. Indeed, if major surgery leaves a scar, a Klingon will wear his scar proudly. Klingons do not use plastic surgery for cosmetic purposes, but to alter someone's appearance for espionage purposes. Many Klingon Fusion undercover spies look completely Human, Vulcan, or Romulan from the outside!

DIFFERENCES IN STUN DAMAGE FOR VARIOUS STAR TREK RACES

	Humans	Romulans	Vulcans	Klingons	
				Fusions	Imperials
Stun Damage					
Hit	75	70	50	60	50
Graze	25	25	20	20	20
Heavy Stun Damage					
Hit	120	110	80	100	80
Graze	40	40	30	35	30

Optional Healing Rate

Klingon metabolic processes are faster than those of most other known races. This also accounts for the ability of Imperial Race Klingons to heal faster than do Humans, Vulcans, or Romulans. (The two Fusion races do not gain this advantage, however, and so heal at the same rate as their non-Klingon counterparts.)

To determine the WOUND HEAL RATE and FATIGUE HEAL RATE for Imperial Race Klingons, calculate the numbers normally, but then round UP rather than down. For example, a Human character with an END score of 55 would heal at 2 points per day ($55/20 = 2.75$, rounded down to 2), but an Imperial Klingon will heal 3 points per day (2.75 rounded up to 3). Imperials also recover from fatigue and stun damage at a faster rate per half-hour. Using the above example, the Human would recover from fatigue damage at a rate of 5 points per half-hour ($55/10 = 5.5$, rounded down to 5), while an Imperial Klingon will recover at 6 points per half-hour (5.5 rounded up to 6). Record these two figures in the WOUND HEAL RATE and FATIGUE HEAL RATE boxes on the Klingon Character Data Record.

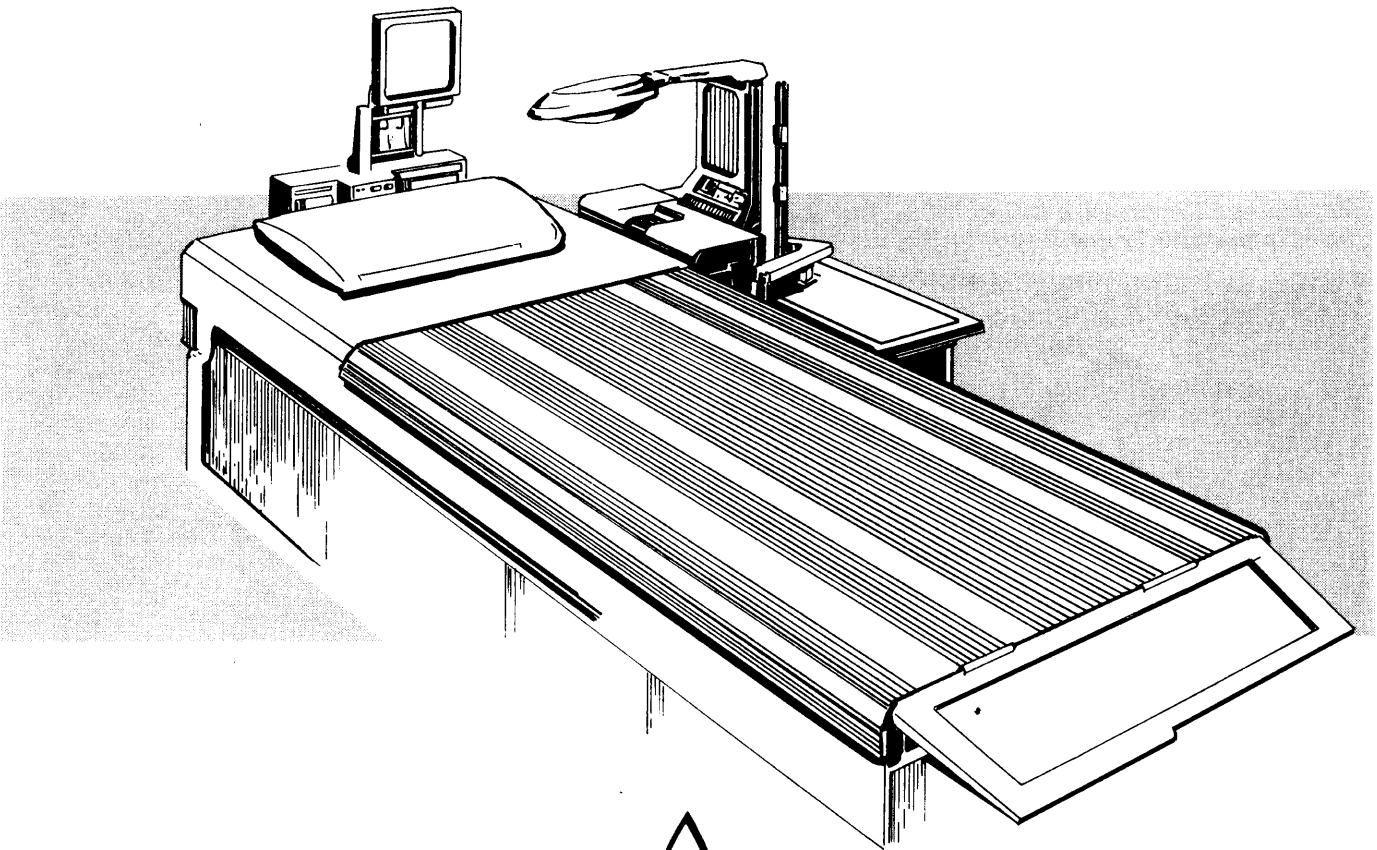

JUDGING EQUIPMENT

Unless specifically mentioned in this section, game-masters may judge Klingon equipment according to the rules for comparable Star Fleet equipment given in STRPG2.

PERSONAL EQUIPMENT

Battle Computer

When tied into a ship's computers, this device can track and target enemy troops in an area up to 500 meters. Using the battle computers increases all *Marksmanship*, *Modern Skill Ratings* by 10 whenever characters engage in combat within its range.

Computer/Recorder, Portable

In most cases, treat the portable computer/recorder as a Star Fleet tricorder. The chances of damaging the unit are the same as for rough handling of the Federation tricorder.

Gamemasters may permit Klingon player characters to apply the information in FASA's *STAR TREK Tricorder/Starships Sensors Interactive Display* for use with the Klingon portable recorder.

Electronic Diary

In theory, it is possible to feed information into this device from a specially modified Federation communications panel.

Emergency Packaged Rations

These are available in 10 person/day quantities.

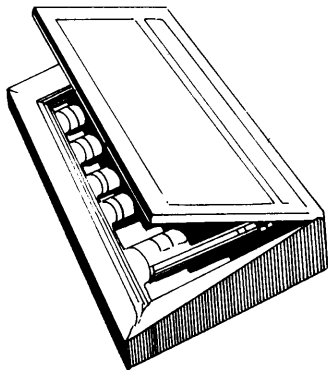

Marine Hypothermia Capsule

Roll percentile dice for each Klingon awakened from "cold sleep". If the roll is 04 or less, the individual dies in the process of "thawing".

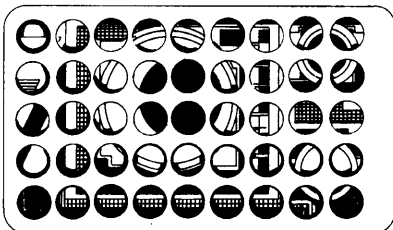

Pocket Scrambler

Anyone attempting to monitor a conversation within ten meters of a pocket scrambler must make two Skill Rolls against his rating in *Security Procedures* to penetrate the scrambling effects.

Universal Translator

To program a language chip for the Universal Translator, the chip is loaded into a programming cart, which is loaded into the ship's language computer. If the language is totally unknown and the culture in question has radio or video transmission capabilities, the computer can break and decode the language in one to ten hours (roll 1D10). If, on the other hand, the culture has no broadcast capabilities, roll 1D10 and divide by 2. The resulting number indicates how many hours of recorded speech the language computer must analyze to provide data for decoding the language. The portable computer/recorder is used to collect these samples on carts to be plugged into the language computer. To decode such language samples requires an additional one to five hours (1D10/2). Any number of language chips can be made once the language is decoded. If the language is a variant of a known language, the gamemaster may decide that it takes much less time to decode and program it into the translator.

There is a 30 percent chance that new languages will be translated immediately. This chance increases for every half-hour of conversation that the device records or is fed in advance. The percentile chance decreases by 10 percent if the language is spoken by a non-Humanoid species.

MEDICAL EQUIPMENT

Laser Scalpel

A physician needs a Skill Rating of at least 40 in *Medical Sciences* to perform surgery with this device.

Organic Suture

A Skill Rating of at least 20 in *General Medicine* is required for most first-aid applications of the organic suture. For surgery involving major blood vessels and delicate work, at least a 40 *Surgery* Skill Rating is needed.

Pneumatic Hypodermic

Anyone with a *General Medicine* Skill Rating of at least 10 may use the hypo safely.

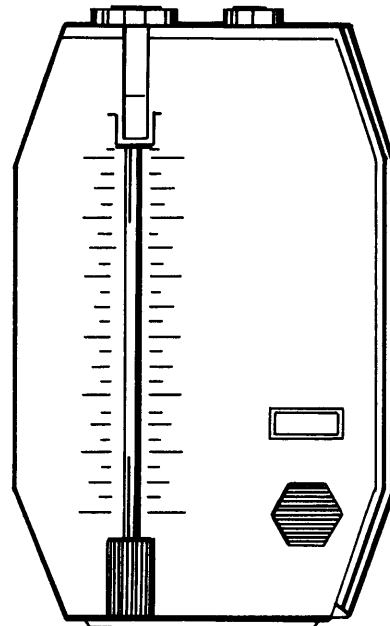

Vital Signs Reader

The device requires one full turn before it provides a readout. During this time, it must remain pressed against the patient's skin. Anyone who understands which buttons to press can operate the unit.

DRUGS AND TOXINS

Whenever a neural drug such as a stimulant, sedative, or neural paralyzer is administered to a Klingon (all sub-races), add 1 extra point per die of effect. For example, a pain-enhancing agent would last for $3D10 + 10$ turns in Humans, but will affect a Klingon for three extra turns ($3D10 + 15$ turns). Also, any drugs that a Klingon inhales or takes orally will take effect 10 percent faster. Thus, if a certain drug normally takes effect in ten turns, it will affect a Klingon in nine turns (10% of $10 = 1$, $10 - 1 = 9$).

Endurance Booster

This drug adds $4D10$ points to a user's *END* score for one-tenth of the user's *END* in hours. After this time, the patient's *END* will drop to half its previous level for the same amount of time. If the number is less than the user's unconsciousness level, he will faint. Despite its dangerous nature, the endurance booster might be administered to an intelligence agent who must continue functioning at peak performance levels.

Pain-Blocking Drugs

Pain-blocking drugs eliminate all pain for $3D10 + 12$ turns. The patient feels no pain during this time, and he has an effective *INACT SAVE* equal to his *UNC THRESH*. Of course, if the patient's *MAX OP END* drops below the *UNC THRESH*, he will pass out anyway. If the patient's *MAX OP END* is reduced below one-half his original *END* score, he must make a Saving Roll against his *END* to remain conscious. A side effect of the drug is that it reduces the patient's *INT* by $1D20$ points while he is under its influence.

Pain-Enhancing Agents

Pain-enhancing drugs magnify all pain that an individual experiences, for a period of $3D10 + 15$ turns. During this time, the patient's *INACT SAVE* is raised to 75 percent of his original *END*. Use of a pain-enhancing drug adds a 20-point penalty to all saving rolls for victims attempting to resist torture.

Suggestibility Agents

The effects of suggestibility drugs last $1D10$ hours. While under the influence of such a drug, the victim is extremely suggestible. If told something he should know to be false, the victim makes a Saving Roll against his *INT* score divided by 3 (rounded down). If the roll fails, the victim will believe what he has heard. He will not believe a patently obvious lie—that his hand is missing when it obviously is not, for example—unless the saving roll failed by an incredible amount. A side effect of a suggestibility drug is that it reduces the victim's effective *INT* score by 20 points, and the victim's eyes are slightly glazed. Though anyone observing the victim for more than ten minutes may notice that there is something wrong (15-point penalty to the observer's Saving Roll against *INT*), a character with *General Medicine* skill of 40 or more will have no penalty to the Saving Roll against *INT*.

Truth Drug

When under the influence of a truth drug, the victim must tell the absolute truth for a period of $3D10 + 21$ turns. He may refuse to answer a direct question if he makes a successful Saving Roll against his *INT* score divided by 4. If he can answer the question truthfully without actually revealing any information, the character does not need to make a Saving Roll.

WEAPONS

Agonizer

When subjected to this device, the victim must make a Saving Roll against his *END* score to take any action at all (other than screaming). A -50 modifier is applied to this roll. When the agonizer is used on Klingons, the penalty is reduced by 10 points. Vulcans may ignore the effects entirely.

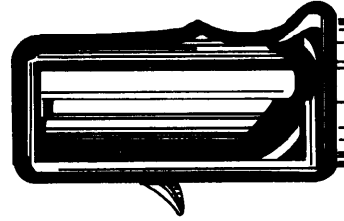

Hand Disruptors and Disruptor Rifles

The data for Klingon hand disruptors and disruptor rifles is listed in the Weapons Table of the **Game Operations Manual** of the basic rules. Wherever a weapon is listed as Type A, it is the Mark I version. (Note that the Hand Disruptor-A listed in the table refers to the Mark I.) Weapons listed as B-versions are Mark II weapons, and C-versions are Mark III weapons. All other information is the same.

Lev'ek (Three-Lobed Knife)

The *Lev'ek* is used like any other knife or dagger, but does $2D10 + 5$ points of damage because of the two extra blades.

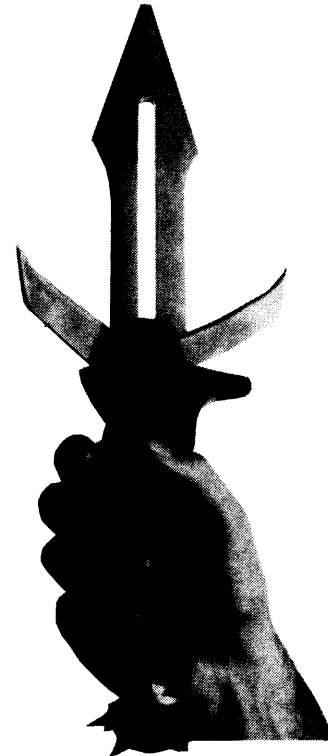

Zhal Sta

If a character using this weapon in open melee misses his target, he must then make an immediate Saving Roll against the average of his *DEX* and *LUC* scores. If that roll fails, the character has inflicted $2D10$ points of damage to himself.

SHIPBOARD SYSTEMS

Agonizer Booth

The agonizer booth adds a 10-point bonus to any interrogation attempt. The operator must have a Skill Rating of at least 30 in *Interrogation* and at least 10 in the appropriate *General Medicine* skill to be effective. Two people (one with each of these two skills) may be substituted for the single operator. A variant on the agonizer booth is the mind sifter, a psychic probe also known as a mind-ripper when used at its highest setting. Vulcans can resist its effects, but Humans are virtually helpless against it. The same rules apply as for the agonizer booth.

Ship's Sensors

When ship's sensors are used to scan for scientific data, apply a 10-point penalty to all Skill Rolls against *Starship Sensors*. On the other hand, the gamemaster may award a 10-point bonus when a character is scanning for combat data such as shield strength, damage to enemy vessels, and similar information.

Cloaking Device

The Klingons have only about 100 ships equipped with this invisibility screen invented by the Romulans. When a ship's cloaking device is activated, it can deceive sensors as well as visual scanners. The device uses so much power that a vessel must deactivate the cloak to be able to use its weapons in combat.

At the time of engaging a cloaking device, a ship, all its contents, and all its occupants suddenly appear to be somewhat transparent. Voices are affected, too, becoming hollow-sounding.

The device puts the tempers of both people and animals on edge. There have even been a few occasions when a cloaking device has driven a Klingon mad.

Surveillance Facilities

When searching for an intruder aboard a Klingon vessel, the officer in charge may make a Skill Roll against his *Surveillance* Skill Rating to find the intruder. If the intruder is in a non-sensitive area, a 10-point penalty is applied to the die roll result. If the attempt is successful, the intruder has been located. Allow the intruder a Saving Roll against either his INT or LUC score (whichever is higher) to see whether he can lose the search patrol in the following turn.

Target Drones

Target drones move at a speed of one hex per turn in ship combat. If mounted with warheads, each drone will cause 5 points of damage if it explodes against a target.



CREATING TYPICAL KLINGON NPCS

At times, the gamemaster will have to create incidental Klingon characters, particularly opponents, that the player characters encounter in a Star Fleet-based campaign. In a Klingon-based campaign, he may need a quick character-creation system even more, because there is no need to generate a full-blown character for every NPC the player characters run into.

Most of the time, all that the game requires is the NPC's name, rank/title, race, gender, key attributes, key skills, and key equipment or knowledge. The following tables provide an abbreviated method for creating typical Klingon NPCs. Most of the time, the gamemaster can do so on the spot, simply by making the die rolls indicated. For most combat situations, however, he should roll up these quick NPCs in advance. Otherwise, he would be slowing down the game at an exciting moment if he waited till the last minute to create them.

ATTRIBUTES

Following are quick formulas for creating the attribute scores of typical Klingon Naval or Marine officers.

Attribute	QUICK ATTRIBUTE SCORES		
	Imperial	Human Fusion	Romulan Fusion
STR	55 + 2D10	55 + 2D10	55 + 2D10
END	45 + 2D10	50 + 2D10	55 + 2D10
INT	45 + 2D10	45 + 2D10	45 + 2D10
DEX	50 + 2D10	45 + 2D10	45 + 2D10
CHA	25 + 2D10	30 + 2D10	35 + 2D10
LUC	20 + 2D10	20 + 2D10	20 + 2D10
PSI	2D10	10 + 2D10	20 + 2D10

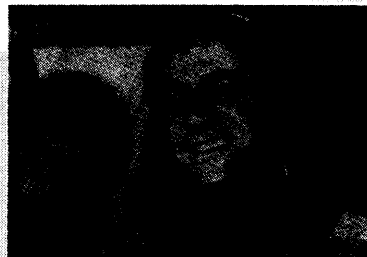

SIGNIFICANT SKILLS

The significant skills and skill ratings given below represent a sample of various specialties available to Klingon characters. The gamemaster may combine them or he may wish to take a bit from one and add it to another to tailor the characters to his liking.

Thought Admiral

Administration	40 + 2D10
Gaming	60 + 2D10
Leadership	60 + 2D10
Negotiation/Diplomacy	50 + 2D10
Starship Combat Strategy/Tactics	60 + 2D10

Captain

Administration	40 + 2D10
Gaming	40 + 2D10
Leadership	50 + 2D10
Starship Combat Strategy/Tactics	50 + 2D10

First Officer

Administration	30 + 2D10
Gaming	30 + 2D10
Leadership	40 + 2D10
Starship Combat Strategy/Tactics	40 + 2D10

Communications Officer

Communication Systems Operation	40 + 2D10
Computer Operation	20 + 2D10
Damage Control Procedures	20 + 2D10
Language, Galacta	10 + 2D10

Navigation/Helm Officer

Space Sciences, Astrogation	40 + 2D10
Starship Helm Operation	40 + 2D10
Starship Sensors	10 + 2D10

Weapons/Defense Officer

Deflector Shield Technology	40 + 2D10
Starship Combat Strategy/Tactics	10 + 2D10
Starship Weaponry Operation	40 + 2D10

Ship's Chief Engineer

Space Sciences, Astronautics	50 + 2D10
Any Technical Specialty	50 + 2D10
Any Technical Specialty	40 + 2D10
Any Technical Specialty	30 + 2D10

Ship's Engineer

Space Sciences, Astronautics	40 + 2D10
Any Technical Specialty	40 + 2D10
Any Technical Specialty	30 + 2D10
Any Technical Specialty	20 + 2D10

Ship's Security Officer

Marksmanship, Modern	50 + 2D10
Personal Combat, Unarmed	50 + 2D10
Security Procedures	50 + 2D10
Small Unit Tactics	40 + 2D10

Ship's Security Guard

Marksmanship, Modern	50 + 2D10
Personal Combat, Unarmed	50 + 2D10
Security Procedures	40 + 2D10
Small Unit Tactics	30 + 2D10

Medical Officer

General Medicine, Klingon	50 + 2D10
Pathology	40 + 2D10
Psychology	30 + 2D10
Surgery	40 + 2D10

Medical Technician

General Medicine, Klingon	40 + 2D10
Pathology	20 + 2D10
Psychology	20 + 2D10
Surgery	40 + 2D10

Science Officer

Computer Operation	40 + 2D10
Starship Sensors	30 + 2D10
Any Science Specialty	50 + 2D10
Any Science Specialty	30 + 2D10

Science Specialist

Computer Operation	30 + 2D10
Starship Sensors	20 + 2D10
Any Science Specialty	35 + 2D10
Any Science Specialty	25 + 2D10

Combat Operations Officer

Marksmanship, Modern	60 + 2D10
Personal Combat, Unarmed	60 + 2D10
Small Unit Tactics	60 + 2D10
Zero-G Operations	40 + 2D10

Combat Operations Soldier

Marksmanship, Modern	60 + 2D10
Personal Combat, Unarmed	60 + 2D10
Small Unit Tactics	30 + 2D10
Zero-G Operations	40 + 2D10

Combat Engineer

Marksmanship, Modern	30 + 2D10
Personal Combat, Unarmed	30 + 2D10
Personal Weapons Technology	30 + 2D10
Demolitions	20 + 2D10
Any Technical Specialty	40 + 2D10
Any Technical Specialty	30 + 2D10

Administrator

Administration	50 + 2D10
Gaming	40 + 2D10
Leadership	40 + 2D10
Negotiation/Diplomacy	30 + 2D10

Diplomat

Administration	40 + 2D10
Gaming	40 + 2D10
Language	20 + 2D10
Leadership	20 + 2D10
Personal Combat, Armed (Knife)	30 + 2D10
Negotiation/Diplomacy	50 + 2D10

DESIGNERS' NOTES

Although the *STAR TREK* TV series, professional and fan fiction, and the recent movies all provide information on the Klingons, much of it is fragmentary, opening up as many questions as it answers. To create a more complete picture of Klingon history, culture, technology, physiology, psychology, and religion, we had to use those fragments as the basis for logical speculation. Though care has been taken to avoid contradicting the TV episodes or movies, most of the 'holes' in Klingon background had to be filled in by the authors' imaginations.

Dave, Greg, and I were not the only ones facing the problem of creating, from whole cloth, an entire background for the Klingon race. Even as *STAR TREK: The Role Playing Game* was being prepared several years ago, author John M. Ford was negotiating with Pocket Books to produce a *STAR TREK* novel whose central characters were Klingons, with action taking place largely against the background of the Klingon Empire.

Ford (known as "Mike" to his close friends) and I were roommates during my graduate school days and for a time thereafter. Mike introduced me to roleplaying games when *Dungeons and Dragons*™ was first released, and taught me my first lessons about being a good gamemaster. He was also one of the shakers and movers of the Indiana University Science Fiction Club, and we often travelled to SF conventions together. Neither of us was totally aware that our lifetime careers were being shaped in these years. Mike has since become a well-known science fiction author, with several novels and short fiction works to his credit, including the novel *The Dragon Waiting*, winner of the World Fantasy Award. My own first published work in roleplaying (a very early *Dragon* article) was completed while we were roommates, and I have remained in the field ever since.

It was perhaps inevitable that our professional paths should cross again, as Mike's interest in roleplaying has continued (when his schedule of science fiction writing permits). He has been the author of a number of roleplaying adventures, as well as articles for such magazines as *The Journal of the Traveller's Aid Society* (now *Challenge* magazine) and *Autoduel Quarterly*. In the field of gaming, he is

known for his somewhat bizarre sense of humor (and for leaving player characters in the most incredibly dangerous positions without warning!).

When we discovered we were working on parallel projects, we couldn't resist a collaboration of sorts. Thus, the research on the Klingon Empire for his novel *The Final Reflection* (Pocket Books) also became the basis for much of the background included in our first edition of **The Klingons**. (Some of the background material given in the player's book is presented as excerpts from *An Informal Guide to the Klingon Empire*, by J. Ford and E. Tagore. This fictional book was published during the time of the *Enterprise's* five-year mission, and was based on the findings of the Committee on the Klingon Estimate, a UFP study group. These excerpts are set off from the rest of the text and are credited.)

Ford, meanwhile, was able to draw on material we had generated on the *STAR TREK* universe when designing the basic game. In this way, both the novel's characters and player characters in the game inhabit a universe that is consistent and mutually supported with rich detail. Indeed, **The Klingons** is not just a game supplement, but also an important reference work on the Klingon Empire.

The Final Reflection went on to become one of the finest pieces of *STAR TREK* fiction ever written. It has changed the way the Klingons are viewed by *STAR TREK* fans everywhere, and I strongly recommend it to anyone interested in roleplaying with the Klingons. (See if you can pick out Greg, Dave, and myself as Klingons in the final chapter of the novel!)

The authors find Klingon society to be a fascinating alien culture. We do *not*, by any means, admire Klingon ideals and practices! As Mr. Spock would say, "Finding a culture fascinating does not imply approval." To understand all is not necessarily to forgive all. (We don't suggest that you be a Klingon, only that you try playing a Klingon!) In writing this, I've become convinced that the Klingons are too fascinating to waste just as foes. Try playing from the Klingon perspective and see why they are among the most popular characters in the *STAR TREK* universe.

—Guy W. McLimore, Jr.
Fantasimulations Associates

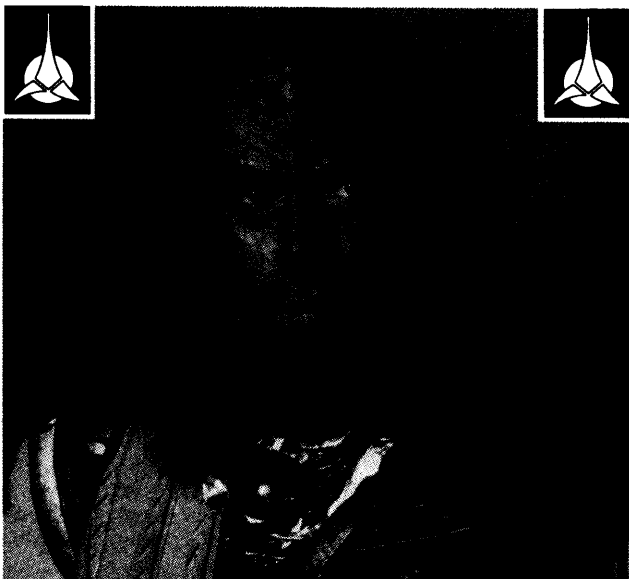

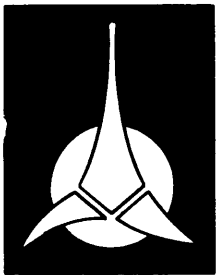

KLINGON CHARACTER DATA RECORD

Name: _____
 Rank: _____
 Assignment: _____
 Ship: IKV _____
 Position: _____

Age: _____
 Sex: _____
 Race: _____

AP

STR	END	INT	DEX	CHA	LUC	PSI
INACT SAVE 20	UNC THRESH 5	MAX OP END	CURR OP END	TO-HIT, MOD	TO-HIT, HTH	TO-HIT,
WOUND HEAL RATE	FATIGUE HEAL RATE				BARE-HAND DAMAGE__	DAMAGE__

Service Experience Chart

Assignment:

- Imperial Expeditionary Forces
- Imperial Navy or Marines
- Sector Garrison or Ground Post
- Exploration/Colonization Fleet
- Merchant/Courier Fleet
- Imperial Star Fortress Duty
- Imperial Academy
- Tour Length (years)
- Security Notation (+, -)

Prime Learning	Skill Mastery	Skill Application						Leaders of Men	Leaders of Vessels	Tours														
		Cruise 1	Cruise 2	Cruise 3	Cruise 4	Cruise 5	Cruise 6			Tour 1	Tour 2	Tour 3	Tour 4	Tour 5	Tour 6	Tour 7	Tour 8	Tour 9	Tour 10					
✓	✓																							
2		1						1	1															

Skill Application
 Cruise Results
 Passed _____
 Honors _____
 Imperial
 Commendation _____

SKILL LIST

- Administration _____
- *Artistic Expression _____
- Bribery _____
- Carousing _____
- Commun. Systems Operation _____
- Commun. Systems Technology _____
- Computer Operation _____
- Computer Technology _____
- Damage Control Procedures _____
- Deflector Shield Operation _____
- Deflector Shield Technology _____
- Electronics Technology _____
- Environmental Suit Operation _____
- *Gaming _____
- Instruction _____
- Interrogation _____
- *Language, Galacta _____
- Leadership _____
- *Life Sciences _____
- Life Support Syst. Technology _____

- *Marksmanship, Archaic _____
- Marksmanship, Modern _____
- Mechanical Engineering _____
- *Medical Sciences _____
- General Medicine _____
- Negotiation/Diplomacy _____
- *Personal Combat, Armed _____
- Personal Combat, Unarmed _____
- Personal Weapons Technology _____
- *Physical Sciences _____
- *Planetary Sciences _____
- *Planetary Survival _____
- Security Procedures _____
- Shuttlecraft Pilot _____
- Shuttlecraft Syst. Technology _____
- Small Equip. Syst. Operation _____
- Small Equip. Syst. Technology _____
- Small Unit Tactics _____

- *Social Sciences _____
- Klingon Cult./Hist. _____
- Klingon Law _____
- *Space Sciences _____
- Astronomy _____
- *Sports _____
- Swimming and Diving _____
- Starship Combat Strat./Tactics _____
- Starship Helm Operation _____
- Starship Sensors _____
- Starship Weaponry Operation _____
- Starship Weaponry Technology _____
- Streetwise _____
- Surveillance _____
- Transporter Operation Procedures _____
- Transporter Systems Technology _____
- *Trivia _____
- *Vehicle Operation _____
- Warp Drive Technology _____
- Zero-G Operations _____

18
17
16
15
14
13
12
11
10
9
8
7
6
5
4
3
2
1

KLINGON CHARACTER GENERATION SHORT FORM

ATTRIBUTES 1

INITIAL ROLL
Die Roll: As below
Modifiers: As below

INITIAL DIE ROLL

Attribute	Roll
STR	3D10 + 40
END	3D10 + 40
INT	3D10 + 40
DEX	3D10 + 40
CHA	3D10 + 40
LUC	D100
PSI	D100

RACIAL MODIFIERS

	STR	END	INT	DEX	CHA	LUC	PSI
Imperial Race	+10	—	—	+5	-30	-40	-60
Human Fusion	+10	+5	—	—	-20	-40	-50
Romulan Fusion	+10	+10	—	—	-10	-40	-40

BONUS POINTS
Die Roll: D100/2, round down
Choice: Any but PSI
Restrictions: No more than 30 to one attribute
No attribute adjusted over 99

PRE-ACADEMY SKILLS 2

Number: INT/10, round down
Rating: 1D10
Choice: one-third from each table

KLINGON PRE-ACADEMY SKILL LISTS

Personal Development
Administration
*Artistic Expression
Bribery
Carousing
*Gaming
Instruction
*Language
Leadership
*Planetary Survival
*Sports
Streetwise
*Trivia

Martial Skills
*Marksmanship, Archaic
Marksmanship, Modern
*Personal Combat, Armed
*Personal Combat, Unarmed
Small Unit Tactics

Education Background
Computer Operation
*Life Sciences
Medical Sciences, General Medicine
Medical Sciences, Psychology
*Planetary Science
Social Science, Klingon History
Social Science, Klingon Law
Space Science, Astronomy
Space Science, Astrophysics
*Vehicle Operation (except space vehicles)

PRIME LEARNING SKILLS 3

CURRICULUM SKILLS
Number: As below
Rating: As below
Choice: All

PRIME LEARNING SKILLS TABLE

Administration	10
Computer Operation	10
Interrigation	10
*Language	40
(at least 30 in Galacta)	
Leadership	10
Marksmanship, Modern	30
*Personal Combat, Armed	20
(in weapon of choice)	
Personal Combat, Unarmed	20
Social Science, Klingon Culture/History	10
Social Science, Klingon Law	10
Space Science, Astronomy	10
Sports, Swimming	5

ADVANCED TRAINING
Number: 4
Rating: 1D10
Choice: Only skills already known

SKILL MASTERY SKILLS 4

BRANCH SPECIALTIES TABLE

Naval Specialties	Marine Specialties
—	Combat Operations
—	Combat Engineering
Communications	Communications
Medical	Medical
Navigation/Helm	—
Sciences	—
Ship's Engineering	—
Security	Security
Weapons/Defense	—

CURRICULUM
Number: As below
Rating: As below
Choice: All from one branch

COMBAT OPERATIONS SKILL TABLE

Environmental Suit Operation	20
Leadership	10
Marksmanship, Archaic (any weapon)	10
Marksmanship, Modern	30
*Personal Combat, Armed (any weapon)	10
Personal Combat, Unarmed	30
Personal Weapons Technology	10
Planetary Survival (any type)	20
Small Unit Tactics	20
Streetwise	20
Vehicle Operation, Ground Vehicle	05
Zero-G Operations	30

COMBAT ENGINEERING SKILL TABLE

Communication Systems Technology	10
Demotions	10
Electronics Technology	10
Environmental Suit Operation	10
Marksmanship, Modern	10
Mechanical Engineering	20
Personal Combat, Unarmed	10
Personal Weapons Technology	20
Security Procedures	10
Small Equipment Systems Operation	10
Small Equipment Systems Technology	10
Surveillance	10
Transporter Operation Procedures	10
Transporter Systems Technology	10
Vehicle Operation, Ground Vehicle	20
Zero-G Operations	10
Specialties	30
(Any Engineering specialties above may be chosen, and the skill rating points spread among them.)	

COMMUNICATIONS SKILL TABLE

Communication Systems Operation	40
Computer Operation	10
Damage Control Procedures	30
Language (Galacta)	20
Language (other)	20
Starship Sensors	20
Transporter Operation Procedures	10

MEDICAL SKILL TABLE

Environmental Suit Operations	10
Interrigation	20
Life Science, Zoology	10
Life Support Systems Technology	10
Medical Science, General Medicine (Klingon)	10
Medical Science, Psychology (Klingon)	10
Medical Science, any other	20
Security Procedures	10
Starship Sensors	20

NAVIGATION/HELM SKILL TABLE

Computer Operation	10
Space Science, Astrologation	40
Space Science, Astronomy	10
Space Science, Astrophysics	10
Starship Helm Operation	40
Starship Sensors	20
Warp Drive Technology	20

SCIENCE SKILL TABLE

Computer Operation	10
Environmental Suit Operation	10
Small Equipment Systems Operation	10
Space Science, Astronomy	10
Space Science, Astrophysics	10
Starship Sensors	20
Any other Science Skills	80
(Any science skill may be chosen, from Life Sciences, Physical Sciences, and Planetary Sciences. At least two must have Skill Ratings of 10 or higher.)	

SHIP'S ENGINEERING SKILL TABLE

Computer Technology	10
Deflector Shield Technology	10
Electronics Technology	10
Environmental Suit Operation	10
Life Support Systems Technology	10
Mechanical Engineering	10
Personal Weapons Technology	10
Physical Sciences, Physics	10
Warp Drive Technology	10
Shuttlecraft Systems Technology	5
Small Equipment Systems Operation	5
Small Equipment Systems Technology	5
Space Science, Astronautics	30
Starship Sensors	10
Starship Weapons Technology	10
Transporter Operation Procedures	10
Transporter Systems Technology	10
Warp Drive Technology	10
Zero-G Operations	10
Specialties	40
(Any Engineering specialties above may be chosen, and the Skill Rating points spread among them.)	

SECURITY SKILL TABLE

Bribery	10
Interrigation	30
Marksmanship, Modern	20
Medical Science, Psychology (Klingon)	10
Negotiation/Diplomacy	15
Personal Combat, Unarmed	10
Personal Weapons Technology	10
Security Procedures	30
Shuttlecraft Pilot	10
Small Unit Tactics	20
Social Science, Federation Law	10
Social Science, Klingon Law	10
Surveillance	20
Zero-G Operations	10

WEAPONS/DEFENSE SKILL TABLE

Computer Operation	10
Deflector Shield Technology	40
Starship Combat Strategy/Tactics	20
Starship Sensors	20
Starship Weapons Operation	40
Transporter Operation Procedures	2

OUTSIDE ELECTIVES
Number: 2 per year in Skill Mastery branch
Rating: 1D10
Choice: Any

ADVANCED TRAINING
Number: 3 per year in Skill Mastery branch, plus (INT - 50)/10, round down
Rating: 1D10
Choice: 5 already-known skills, remainder from Specialty Skill Table

SKILL APPLICATION SKILLS 5

ASSIGNMENT
Die Roll: D100
Modifiers: As below

SKILL APPLICATION CRUISE ASSIGNMENT

Die Roll	Result
25 or less	Imperial Klingon Expeditionary Forces
26-40	Imperial Navy or Marines
41-65	Sector Naval Garrison or Marine Outpost
66-80	Exploration/Colonization Fleet
81 or more	Merchant/Courier Fleet

Die Modifiers

Character is member of Imperial Race	-20
LUC 40 or more	-10
LUC 35-39	-5
LUC 20 or less	+5
INT 70 or more	-10
INT 60-69	-5
Failed to pass last Skill Assignment	+10
Each negative Security Notation	+2
Each positive Security Notation	-2
Successful Bribery Skill Roll	next higher assignment
Unsuccessful Bribery Skill Roll	next lower assignment

SECURITY NOTATION
Die Roll: Saving Roll against character's CHA score
Modifiers: None

SECURITY NOTATION TABLE

Successful Roll	Positive Mark
Unsuccessful Roll	No Mark
Roll unsuccessful by more than 10	Negative Mark

CRUISE RESULT
Die Roll: D100
Modifiers: As below

CRUISE RESULT TABLE

Die Roll	Result
5 or less	Passed with Imperial Commendation (see below)
6-15	Passed with Honors (see below)
16-60	Passed
61 or more	Failed. Repeat Skill Application.

Die Modifiers

Imperial Klingon Expeditionary Forces	-20
Imperial Navy or Marines	-15
Sector Naval Garrison or Marine Outpost	-10
Exploration/Colonization Fleet	+10
Merchant/Courier Fleet	+20
LUC 40 or more	-10
LUC 35-39	-5
LUC 20 or less	+5
Second or later cruise	+10
For each negative Security Notation	+5
For each positive Security Notation	-5
Successful Bribery Skill Roll	character automatically passes
Unsuccessful Bribery Skill Roll	character automatically fails and receives negative security mark

SKILLS GAINED
Number: 5 per year in Skill Application
Rating: 1D10
Choice: 3 from Skill Mastery Specialty
2 open

LEADERS OF MEN SKILLS 6

CURRICULUM
Number: As below
Rating: As below
Choice: All

LEADERS OF MEN CURRICULUM TABLE

Administration	25
Interrigation	20
Leadership	20
Security Procedures	10

ADVANCED TRAINING
Number: INT/10, round down
Rating: 1D10
Choice: Only those already known

RANK
Automatic one rank promotion

LEADERS OF VESSELS SKILLS 7

CURRICULUM
Number: As below
Rating: As below
Choice: All

LEADERS OF VESSELS CURRICULUM TABLE

Leadership	10
Social Science, Federation Law	10
Social Science, Klingon Law	10
Starship Combat Strategy/Tactics	30

ADVANCED TRAINING
Number: INT/10, round down
Rating: 1D10
Choice: Only those already known

RANK
Automatic one rank promotion

SERVICE EXPERIENCE AND SKILLS 8

NUMBER OF TOURS SERVED
Die Roll: (1D10-1)/2, round down
(If result is 0, make it 1)
Modifiers: As below

MODIFIERS TO TOURS OF DUTY SERVED

For Attributes

INT 60 or more	-1 tour
LUC 40 or more	-1 tour
LUC 20 or less	+1 tour

For Destined Rank

Ensign	-1 tour
Lieutenant (j.g. or Lieutenant)	No Modifier
Lieutenant Commander or Commander	+1 tour
Captain	+2 tours
Admiral or above	+3 tours

For Destined Position, Cumulative

Captain or First Officer	+2 tours
Department Head	+1 tour
Imperial Klingon Expeditionary Forces	+1 tour

TOUR ASSIGNMENT
Die Roll: D100
Modifiers: As below

TOUR ASSIGNMENT TABLE

Die Roll	Result
10 or less	Imperial Klingon Expeditionary Forces
11-30	Imperial Navy or Marines
31-50	Sector Naval Garrison or Marine Outpost
51-70	Exploration/Colonization Fleet
71-80	Merchant/Courier Fleet
81-90	Imperial Star Fortress Duty
91 or more	Imperial Naval Academy

Tour Assignment Modifiers

INT 70 or more	-10
INT 60-69	-5
LUC 40 or more	-5
LUC 20 or less	+5
Each negative Security Notation	+5
Each positive Security Notation	-5

First Tour Only

Graduated with Imperial Commendation	-20
Graduated with Honors	-10

TOUR LENGTH
Die Roll: (1D10-1)/2 years, round down
(If result is 0, make it 1)
Modifiers: None

SECURITY NOTATION
Die Roll: Saving Roll against character's CHA score
Modifiers: As below

SECURITY NOTATION TABLE

Successful Roll	Positive Mark
Unsuccessful Roll	No Mark
Roll unsuccessful by more than 10	Negative Mark

SECURITY NOTATION MODIFIERS

INT 65 or more	-10
INT 40 or less	+10
LUC 40 or more	-10
LUC 20 or less	+10
Each previous negative Security Notation	+2
Each previous positive Security Notation	-2
For every 10 points of Security Procedures Skill	-5

SERVICE SKILL ADVANCEMENT
Number: Years of Service/2, round down
Rating: 1D10
Choice: Any

SERVICE SKILL MODIFIERS

INT 70 or more	2 extra rolls
INT 60-69	1 extra roll
LUC 40 or more	1 extra roll
Per 2 years served in Imperial Klingon Expeditionary Forces	1 extra roll
Per year of Imperial Star Fortress Duty	1 extra roll on Streetwise or Garming
Per additional Cadet Cruise beyond first	1 extra roll on Streetwise, Garming, or Carousing

CHARACTER AGE 9

Age when entering Academy

Prime Learning	12
Skill Mastery	+2
Combat Engineering	+3
Combat Operations	+3
Communications	+2
Medical	+2
Navigation/Helm	+2
Sciences	+2
Ship's Engineering	+3
Security	+3
Weapons/Defense	+2
Skill Application	+1 per cruise
Leaders of Men School	+1
Leaders of Vessels School	+1
Per Year of Service	+1

T·H·E KLINGONS

GAME · OPERATION · MANUAL

"And though I had slain a thousand foes less one,
The thousandth knife found my liver;
The thousandth enemy said to me,
'Now you shall die,
Now none shall know.'
And the fool, looking down, believed this,
Not seeing, above his shoulder, the naked stars,
Each one remembering."



It is an ancient Klingon belief—the naked stars remember acts of courage performed under them. Find out why in **The Klingons**.

A must for players and gamemasters alike, this updated second edition contains two books. The **Game Operations Manual** presents the truth about the Klingon Empire for the gamemaster and Klingon player characters. Included are character generation rules, equipment guidelines, the Empire's political and economic structure, Klingon philosophy, and much, much more.

The second book, the **Star Fleet Intelligence Manual**, includes all the information that Star Fleet knows about the Klingon Empire. Compiled from intelligence agents' reports, interrogation, and analysis of captured Klingon equipment, this manual is Star Fleet Intelligence Command's latest briefing on the Federation's most dangerous foe.



34057 02002

ISBN 0-931787-02-5 FASA 1500

STAR TREK is a Registered Trademark of Paramount Pictures Corporation.

STAR TREK: The Role Playing Game is published by FASA Corporation under license from Paramount Pictures Corporation, the trademark owner. Copyright © 1987 Paramount Pictures Corporation. All Rights Reserved. Printed in the United States of America.