

A supplement for use with  
**STAR TREK**<sup>®</sup>  
THE ROLE PLAYING GAME

2002

# T·H·E KLINGONS



**FASA**  
CORPORATION

STAR·FLEET·INTELLIGENCE·MANUAL

# TABLE OF CONTENTS

<b>OFFICER'S ORIENTATION BRIEFING</b> . . . . .	3
Preface . . . . .	3
Contents of this Book . . . . .	3
About the Editor . . . . .	3
<b>An Informal Guide to the Klingon Empire:</b>	
<b>A Retrospective View</b> . . . . .	4
<b>A Second Viewpoint</b> . . . . .	4
<b>Glossary of Klingon Terms</b> . . . . .	5
<b>The Klingon Language</b> . . . . .	9
Variations . . . . .	9
Military Salutation . . . . .	10
Battle Language . . . . .	10
Klingon Epithets . . . . .	11
<b>THE KLINGON EMPIRE</b> . . . . .	12
<b>Timeline</b> . . . . .	12
<b>Klingon Home System</b> . . . . .	15
<b>Klinzhai</b> . . . . .	16
Sivi . . . . .	16
<b>Extent of the Empire</b> . . . . .	18
Organian Treaty Zone . . . . .	18
Klingon Neutral Zone . . . . .	18
Klingon/Romulan Border . . . . .	18
Triangle Holdings . . . . .	18
The Unknown Frontier . . . . .	18
<b>Interstellar Relations</b> . . . . .	19
United Federation of Planets . . . . .	19
Romulan Star Empire . . . . .	20
Orion Colonies . . . . .	21
Gorn Alliance and the Tholian Assembly . . . . .	21
The "Unknowns" . . . . .	21

<b>THE KLINGON PEOPLE</b> . . . . .	22
<b>Klingon Psychology</b> . . . . .	22
Conflict . . . . .	22
Survival . . . . .	22
Success . . . . .	22
Unity . . . . .	22
<b>The Klingon Mind</b> . . . . .	23
<b>Stages of Klingon Life</b> . . . . .	24
Early Family Life . . . . .	24
Adult Life . . . . .	24
<b>Klingon Social Structure</b> . . . . .	25
Family Lines . . . . .	26
<b>Linenames</b> . . . . .	26
Status and Names . . . . .	27
<b>Consortship</b> . . . . .	28
<b>The Klingon Races</b> . . . . .	29
Imperial Race . . . . .	29
Fusion Races . . . . .	30
Psionic Prohibitions . . . . .	30
<b>Government</b> . . . . .	31
<b>Klingon Politics</b> . . . . .	32
<b>Civilian Ranks and Titles</b> . . . . .	33
<b>Religion</b> . . . . .	33
<b>KLINGON ARMED FORCES</b> . . . . .	34
<b>Imperial Fleet</b> . . . . .	34
Organization . . . . .	34
Ranks . . . . .	34
<b>Academy Education</b> . . . . .	35
Prime Learning . . . . .	35
Skill Mastery . . . . .	36
Skill Application . . . . .	37
Advanced Training . . . . .	37
Shipboard Life . . . . .	38
Starship Recognition File . . . . .	38
Klingon Starship Tactics . . . . .	41
<b>Imperial Marines</b> . . . . .	42
Organization . . . . .	42
Rank . . . . .	42
Weapons and Tactics . . . . .	42
<b>Klingon Diplomatic Corps</b> . . . . .	42
<b>EQUIPMENT</b> . . . . .	43
<b>Personal Equipment</b> . . . . .	43
<b>Vehicles</b> . . . . .	46
<b>Medical Equipment</b> . . . . .	46
<b>Weapons</b> . . . . .	48
<b>Shipboard Systems</b> . . . . .	50



## THE KLINGON EMPIRE

### **Design:**

Fantasimulations Associates  
Guy W. McLimore, Jr.  
Greg K. Poehlein  
David F. Tepoch

### **Writing:**

Fantasimulations Associates  
(based on original material by John M. Ford)

### **Additional writing:**

Donna Ippolito  
Todd Huettel

### **Continuity:**

Forest G. Brown  
C. W. Hess  
Josh W. Spencer

### **Editorial Staff**

*Editor-In-Chief*  
L. Ross Babcock III  
*Senior Editor*  
Donna Ippolito  
*Editor*  
Todd Huettel

### **Production Staff**

*Production Manager*  
Jordan K. Weisman  
*Art Director*  
Dana Knutson  
*Cover Design*  
Jeff Laubenstein  
*Illustration*  
Todd F. Marsh  
Dana Knutson  
Jeff Laubenstein  
Mitch O'Connell  
*Typesetting and Layout*  
Tara Gallagher  
*Pasteup*  
Todd F. Marsh  
Dana Knutson

# OFFICER'S ORIENTATION BRIEFING

## PREFACE

The Klingon Bureau of Star Fleet Intelligence Command has prepared this sourcebook to provide line and staff officers with a general overview of the Klingon Empire, the Klingon people, and the Klingon Imperial forces. It provides Star Fleet officers with most of the background information they will need to deal with any Klingons they encounter during this time of uneasy peace. For more detailed information, refer to other specialized volumes published by Star Fleet or FASA, especially **The Four Years War**, **Klingon Intelligence Briefing**, and the **Klingon Ship Recognition Manual**.

**The surest way to defeat your enemy is to become his friend.**

—Traditional Klingon saying

A great deal of material from many different sources has been used in the preparation of this volume. Where sections of other works or writings of other authors have been quoted verbatim, the original authors and sources are credited. Where no specific credit is noted, the material was written by the editor and staff from data compiled from a large number of official and unofficial sources.

## CONTENTS OF THIS BOOK

The editor's introduction explains the scholarly basis for this volume. It also provides a glossary of Klingon terms and notes on the Klingon language.

The **Klingon Empire** section contains a timeline of the important dates in Klingon history. It also includes a summary of that history and a survey of what is known about the Klingon home system and the extent of the Empire. Finally, there is a briefing on Klingon relations with other major interstellar powers.

In the third section, **The Klingon People** are discussed in a variety of essays, papers, and excerpts from longer works. This section should help officers better understand the Klingon personality and social atmosphere.

The fourth section discusses the **Klingon Armed Forces**, including notes on organization, ranks, weapons, and tactics employed by the Klingon Imperial Fleet, Imperial Marines, and the Imperial Contacts Branch, with its infamous Klingon Diplomatic Corps. This overview is intended as a basic guide to Imperial military structure. More detailed discussions of Klingon military strength and tactics are available in other Star Fleet or FASA publications.

The final section of the book describes and illustrates **Equipment** used by the Klingon Imperial armed forces, serving as a guide for the identification of alien weapons and equipment, as well as to what the standard Klingon officer or enlisted man might carry in the field.

## ABOUT THE EDITOR

The editor of this volume is Captain Sara B. Jankowski, Star Fleet Intelligence Service. While serving as an ensign during the Four Years War, she was twice decorated for her undercover work in the Triangle. Jankowski also served as a staff officer during the postwar adjustment period, working directly with Klingon negotiators.

When war broke out again over the planet Organia, Jankowski (now a full Lieutenant) acted as Assistant Intelligence Coordinator for the UFP attack fleet. When the Organians disarmed both the UFP and Klingon fleets and imposed peace, she was among the first UFP officials to arrive at Organia to begin the process that led to the Organian Peace Treaty.

Jankowski was promoted to Lieutenant Commander for her work on the mutual inspection clause of the treaty, and was assigned to the Organian Liaison Office, which investigated and reported on possible treaty violations. During this time, she often ventured into the field, gathering firsthand information on Klingon-held worlds whose development the Organian administrators of the treaty wished to monitor.

During one of these field assignments, Captain Jankowski uncovered evidence linking a group of renegade Klingon agents to crop failures on seven Federation-held worlds in the Treaty Zone. In the course of this mission, she was severely wounded by the renegades, and barely escaped with her life and the vital information. As a result of her work, Organian examiners ceded six Klingon-claimed worlds to the UFP. (One, formerly known as "Kahless' Eye", was renamed "Sara B" in her honor by the new UFP colonists.) Jankowski received a field promotion to Commander; after a lengthy period of recovery, she also received a citation for conspicuous gallantry and a second promotion to Captain.

Jankowski's wounds left her right arm paralyzed, but she refused to accept a medical discharge. She transferred to the historical section of the Intelligence Service, where she currently serves as Assistant Director of Publications.

—Information compiled by Captain Donald C. Wilkinson,  
Director of Publications, Star Fleet Intelligence  
Service



## AN INFORMAL GUIDE TO THE KLINGON EMPIRE: A RETROSPECTIVE VIEW

—by Captain Sara B. Jankowski, *Star Fleet Intelligence Service*

No popularly published work created a greater storm of controversy in Star Fleet than *An Informal Guide to the Klingon Empire*, by John Ford and Emanuel Tagore. A plain-spoken, scholarly man, the late Dr. Tagore was often the center of such controversy, however, because he refused to let politics stand in the way of his search for truth. To this day, Tagore's co-author, who compiled *The Informal Guide* from the late professor's notes, refuses further comment on the book, claiming it speaks for itself.

It spoke loudly enough when most of the manuscript was presented as part of the findings of the Committee on the Klingon Estimate almost three years ago. The conservative halls of Star Fleet did not look favorably on that committee's findings, and simply ignored most of the report. When these findings were published in book form, however, they captured the popular limelight. For some readers, the book made 'the Klingon menace' loom as a larger, more immediate threat. For others, it sparked a new examination of the relationship between the Empire and the UFP.

**"Always assume that the other player is an enemy and that the next move is a trap."**

—Klingon saying

This present document was prepared entirely from Star Fleet's own independent studies, records, and material, much of it commissioned after Star Fleet had rejected the Report of the Committee on the Klingon Estimate. We have examined data from sources as varied as Operation Dixie, the Orion Great Hall of Family Records, and the private datanet of the Imperial Klingon States' Merchant's Cooperative. The result is the most accurate picture of the Klingons and their Empire produced to date, including verification of most of the Ford/Tagore findings.

Today, many Star Fleet spokesmen say that it was not that those findings were unacceptable, but rather that the Ford/Tagore report was too sympathetic toward the Klingons. It is not the editor's aim to debate such points of interpretation in this work, but few will deny that Star Fleet did itself a great disservice by ignoring the Ford/Tagore documents for so long.

In compiling this report, I often quote from *An Informal Guide to the Klingon Empire* to illustrate points and to provide examples. These excerpts are boxed and shaded to separate them from the basic text and from excerpts from other works. Researchers and personnel interested in a more intimate portrayal of Klingon life may also want to consult the equally controversial work, *The Final Reflection*, by author Ford. Published as a follow-up to the Ford/Tagore report, it is a novelization of certain incidents in the life of a Klingon whose fate became intertwined for a time with that of Emanuel Tagore, Ford's mentor and friend. *The Final Reflection* is valuable for the new slant that it offers on the Klingons as individuals and as a people.

## A SECOND VIEWPOINT

—by Commodore Tav'al Desha'andri, retired; Former Military Liaison to the Organian Treaty Administration

Far be it from me to deprive Captain Jankowski of the use of any source material she wishes. As a military commander who has faced the Klingon foe in one war and any number of skirmishes, however, I must protest her conclusion that any material presented here vindicates the Ford/Tagore report.

Perhaps part of my reluctance to accept the Ford/Tagore work comes from my Andorian heritage. Earth-born humans such as Captain Jankowski have known much war in their history, but their society is not based on war to the extent of my own. Andorians are warriors born, and so we understand the martial mentality all the more keenly. The Klingons resemble us in that respect, but are unlike us in another important way.

Andorian wars were fought for honor, for family, and for territory. In becoming members of the Federation, we found we could claim honor, protect family, and acquire territory without the endless bloodshed that had previously stained our history. The Klingons, too, have fought for these reasons, but they also revel in the joy of combat and the thrill of victory. Humans revere peace, and so celebrate when a war is over. Andorians revere victory, celebrating when our needs are satisfied. Klingons celebrate when a battle begins, revering the state of war even more than the fruits of victory. By their very nature, they will crave battle, and it is this essential quality that Ford and Tagore's *Informal Guide* would deny. Understanding the Klingon culture does not make it any more palatable.

This does not mean that the UFP and the Klingon Empire must fight today. But the Klingons must fight, someone, somewhere, or else cease to exist as a race. If it is not the UFP, it will be another enemy on another front.

Vulcans believe that aggression is a psychological abnormality that can be overcome, and current human psychological research also tends in that direction. Andorians, on the other hand, believe that aggression is a part of our nature that must be controlled or channelled, and even expressed directly when necessary. A Klingon, however, bases his life on aggression. What he wants, he takes, because he believes that only the strong survive. It is unlikely that such an aggressive race could find true reconciliation with any other people for very long.

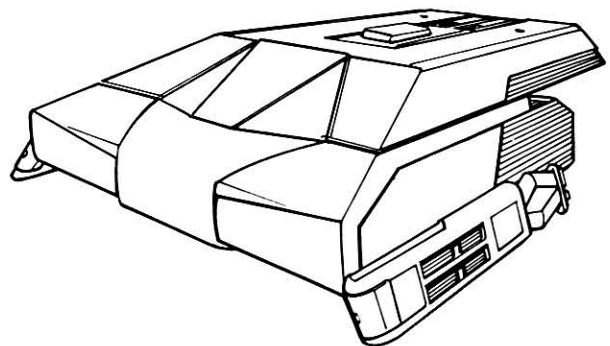

## GLOSSARY OF KLINGON TERMS

### AGONIZER

The agonizer is a device that creates intense pain through direct stimulation of the nervous system. Klingon officers often use hand-held versions to inflict punishment on their subordinates. To operate an agonizer, the user must touch the device against a major nerve center on his victim, which stimulates the surface nerve endings. The more complex agonizer booths can selectively induce pain by direct stimulation of the brain, and are primarily used as instruments of torture. Agonizers can also be used to stimulate the nerves in emergency situations, such as keeping alive a Klingon who is in cryogenic stasis.

### BARRIER GARMENT

The barrier garment is worn by many Klingons when visiting worlds whose climates are more suitable to Humans. The black garment is insulated to keep the wearer warm. It contains a layer of vapor barrier that prevents the Klingon's extremely efficient heat-exchanging system from losing too much moisture through perspiration. (Climates comfortable to the Human metabolism are likely to be somewhat too dry and cold to suit Klingon physiology.)



### BATTLECRUISER

Though the term is often used indiscriminately for any Klingon warship, a battlecruiser is actually a light-to-heavy cruiser warship.

### BATTLE LANGUAGE

Battle language is an extremely efficient version of *Klingonaase* that uses contractions and short forms of words and phrases to give distinct and rapid commands during combat in space or on the ground.

### CIVILIAN GOVERNORSHIP

When the Klingons are developing a servitor world, civilian governorship is typically the third stage. This system places control of day-to-day governmental affairs in the hands of a Klingon civilian administrator.

### CLAN

Klingon line families are sometimes referred to as clans.

### CONSORTSHIP

The legal arrangement that is the Klingon equivalent of matrimony.

### DISRUPTOR

The disruptor is a common Klingon personal weapon that uses a microwave beam to disrupt the structure of living tissue or (at higher power levels) any solid matter. Early models used focused sound waves instead of microwaves, but such "sonic disruptors" are now considered outmoded. (As sound cannot travel through a vacuum, "sonic" disruptors were *never* used as spacecraft weaponry! Even so, the focused microwave version is sometimes erroneously referred to as a sonic disruptor.)

### EMPEROR

The Emperor is the hereditary ruler of the Klingon Empire. Though, by tradition, his power is absolute, the Imperial Council acts as a partial restraint on the Emperor. If displeased or in disagreement with him, the Council can have the Emperor replaced, exiled, or assassinated.

### FUSION RACES

Fusions are Klingon subraces that have been genetically engineered to compete with other major spacefaring races that the Empire has encountered. Fusion races blend Klingon traits with the best and most competitive characteristics of another race to form a new branch of the Klingon species. Klingon/Human and Klingon/Romulan Fusions are known, and others are possible. The Klingon physiology is dominant in such fusions, whose body chemistry, internal structure, and so on is similar to that of Imperial Race Klingons. When Fusion-race Klingons interbreed with Imperial Klingons, random genetic selection will produce offspring whose dominant characteristics are either of the Imperial Race or the appropriate Fusion race.

Though Fusions are more suited than Imperial Race Klingons to living and fighting in various alien environments, they are socially (but subtly) subordinate to members of the Imperial breed in the Empire. Fusion races outnumber Imperial Klingons in many border areas, however, and at least one Klingon Emperor may have been a Klingon/Human Fusion.

### GALACTA

The official language of the United Federation of Planets, Galacta is a regularized, somewhat restructured form of the Terran language known as English. Galacta is taught as a second language almost everywhere in the UFP. Among Human cultures, it has often been adopted as the primary language. Many Klingons, particularly Klingon/Human Fusions in active military service, also speak Galacta as a second language.

### GIVEN NAME

A Klingon receives a personal name at birth. Once the Klingon child is pledged to a service (at age ten), the first initial of this name is changed to the appropriate service code (*K* for Navy, *M* for Imperial Marines, *A* for academic or bureaucratic services). This is a mark of maturity. For example, the child Loanth, upon maturity and pledging to the Imperial Navy, becomes known as Koanth.

## GREAT GAME

Many Klingons believe that the *komerex zha* (literally translated as "game of empire", or "game of growing culture") is the focus of life's effort. It is also known as the "perpetual game".

## HONORIFIC

An honorific is a prefix to a Klingon linename that denotes personal status. In ascending order of status, the honorifics are *tai*, *vestai*, *sutai*, *zantai*, and *epetai*. The honorific precedes the linename, as in Kang *zantai*-Dvistrill, for example. (A youth who has done nothing noteworthy would, of course, have *no* honorific.)

## HUMAN EMPIRE

In an earlier period, Klingons referred to the United Federation of Planets as the Human Empire because they believed Humans dominated the organization. The term is no longer used, except in an insulting manner (perhaps to an Andorian diplomat). Though the Klingons still do not fully understand the cooperative nature of the Federation, they do now perceive that Humans have chosen to share governing power with leaders of other races. Klingons consider this a sign of the weakness of Humans and of the Federation.



## HYPOTHERMIA CAPSULE

Klingons use these coffin-shaped devices to transport Marines in 'cold sleep' aboard their vessels. In cold sleep, an individual's metabolism slows down significantly through reduced body temperature. In this state, troops take up less living space and need less nourishment and oxygen, which allows Klingon vessels to carry greater numbers of ground troops than would otherwise be possible. About 1 of every 25 persons placed in a hypothermia capsule does not survive the 'thawing' process.

## IKS

See **Imperial Klingon States** below.

## IMPERIAL CONTACTS BRANCH

This arm of the Klingon Imperial government is charged with bringing new territory under Klingon control through any means, short of direct military force. The infamous Klingon Diplomatic Corps is a section of the Imperial Contacts Branch.

## IMPERIAL COUNCIL

Officially, the Imperial Council is an advisory body whose members are appointed solely at the Emperor's discretion. In practice, however, the Council is composed of powerful line leaders, whose views the Emperor must take

into account with every decision he makes. Most Councilmembers are believed to have been "self-appointed" by gathering so much power that they could not be denied a seat in this body.

## IMPERIAL FLEET

The Klingon Imperial Fleet may refer either to the entire Imperial Navy (see **Imperial Navy**), or to any major Naval strike force under the direct command of the Emperor or Imperial Council, as in a declared war.

## IMPERIAL HOUSEHOLD

The Imperial Household consists of the close line-brothers and advisors of the Emperor, forming a kind of extended cabinet.

## IMPERIAL INTELLIGENCE

The mission of Imperial Intelligence is to collect and analyze information concerning forces hostile to the Empire, be they external or internal. Originally created as the Emperor's watchdog agency, Imperial Intelligence eventually solidified its position and became the power behind the throne. Intelligence agents are presumably entrenched throughout all the service branches, including Imperial Security.

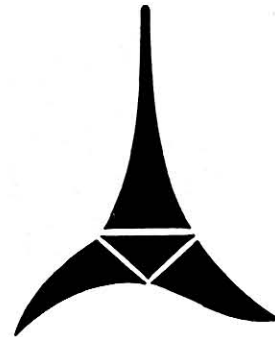

## IMPERIAL KLINGON EXPEDITIONARY FORCES

The Expeditionary Forces are the exploration, conquest, and expansion arm of the Imperial Navy, and represent the elite section of the Exploration/Colonization branch of the Klingon Imperial Forces. Because they are most often sent on missions of conquest (with status and power awarded for success), assignment to the Expeditionary Forces is a mark of distinction.

## IMPERIAL KLINGON STAR ACADEMY

Candidates for officer positions in both the Klingon Imperial Navy and Klingon Imperial Marines attend this system of schools. Klingon officer candidates enter the Star Academy at age twelve (Terran years) and normally attend for four or five years.

## IMPERIAL KLINGON STATES

The IKS is a small but thriving governmental unit in the Triangle that claims to be the rightful Klingon Imperial government in exile. Admiral Kamato and his political allies founded this group of worlds after a failed coup forced them to flee the Empire. The independent government of the IKS operates along the lines of the Klingon Empire, but on a far smaller scale. It has trade agreements with a number of UFP allies, but no major power recognizes it as the legitimate Klingon government.

## IMPERIAL MARINES

The Imperial Marines are the spaceborne ground forces of the Klingon Empire. Like most similar services (including the Federation Marines of the UFP), they are an elite fighting group, trained for planetary assault and defense operations. Some Marine units are stationed aboard larger Klingon naval vessels, while others are ground-based.

## IMPERIAL NAVY

The Imperial Navy represents the space combat forces of the Klingon Empire, including all support vessels. The Imperial Navy is also sometimes known as the Klingon Imperial Fleet. By Imperial doctrine, all space vessels in the Empire (even those privately owned) are arms of the Klingon Imperial Fleet, and the Empire may call them into active service at any time.

## IMPERIAL RACE

Imperial Race Klingons are the original Klingon physical type, distinguished by a bony ridge protecting the crown of the head. Members of the Imperial Race far outnumber other types of Klingons in the interior of the Empire, and maintain an unofficial (but recognizable) social dominance in Klingon society. See also **Fusion Races**.

## IMPERIAL SECURITY

Imperial Security is the secret police of the Klingon Empire. Nominally under the direct control of the Emperor, this service has developed into a power unto itself, controlling and monitoring almost every facet of Klingon life through suspicion and terror. No one chooses to enter the security service, the way one might enter the Navy or Imperial Marines. All security personnel are secretly recruited from out of the other services. Imperial Security orders often take precedence over military commands.

## IMPERIAL TREFOIL

The heraldic symbol of the Klingon Empire, the trefoil is an irregular, multi-colored, three-sided star emblazoned over a smaller circle.

## KLINGON DIPLOMATIC CORPS

See **Imperial Contacts Branch**.

## KLINGON EMPIRE

The Klingon Empire consists of the worlds dominated or controlled by the Klingon Emperor and Imperial Council, including colonies, protectorates, and servitor worlds. This name is also popularly used to refer to the area of space where most of these worlds are found.

## KLINGONESE

Though non-Klingons commonly refer to the Klingon language as *Klingonese*, the proper word is *Klingonaase*, meaning "the speech of the Klingon people".

## KLINGON HIGH COMMAND

The Klingon High Command is a coalition of Naval and Marine officers that directs Klingon military operations at the highest level. The High Command reports directly to the Emperor.

## KLINZHAI

Klinzhai is the Klingon homeworld, whose precise location remains unknown.

## KUVE

The Klingon term for servitor is *kuve*, which denotes an individual, group, or race that serves another because it is their destined position in life to do so. To the Klingons, therefore, the *kuve's* existence is honorable *because* he fulfills his destiny.

Indeed, the Klingons automatically consider most non-spacefaring races they encounter to be *kuve*, unless their actions somehow prove otherwise. In fact, Klingons consider that the vast majority of races were destined to become servitors of the Empire. On the other hand, they would be likely to consider a race that had developed space travel on its own to be a non-servitor race (and hence a potentially worthy rival), until proven otherwise.

Do not confuse *servitor* with *slave*. A slave is one who turned aside from a higher destiny when he agreed to serve—a totally dishonorable position, from the Klingon point of view. According to their own philosophy, the Klingons were born to conquer and rule. Thus, a Klingon, by his nature, cannot be a servitor. To call a Klingon a "willing slave" (*tokhe straav*) is the worst possible insult.

## LINE

A line is an extended Klingon family, the most important social unit in Klingon society. It is also known as a *linefamily*.

## LINEBROTHER

The term *linebrother* (or *linesister*, where appropriate) refers to a member of one's own Klingon family line.

## LINE CHIEF

The line chief is the head of a Klingon family line, usually the most influential member (but not necessarily the eldest).

## LINENAME

This portion of the Klingon name designates the larger family group to which the individual belongs and owes allegiance. It is the third part of the full Klingon name, following the given name and then the honorific, as in Kan zantai-*Dvistrill*, for example.



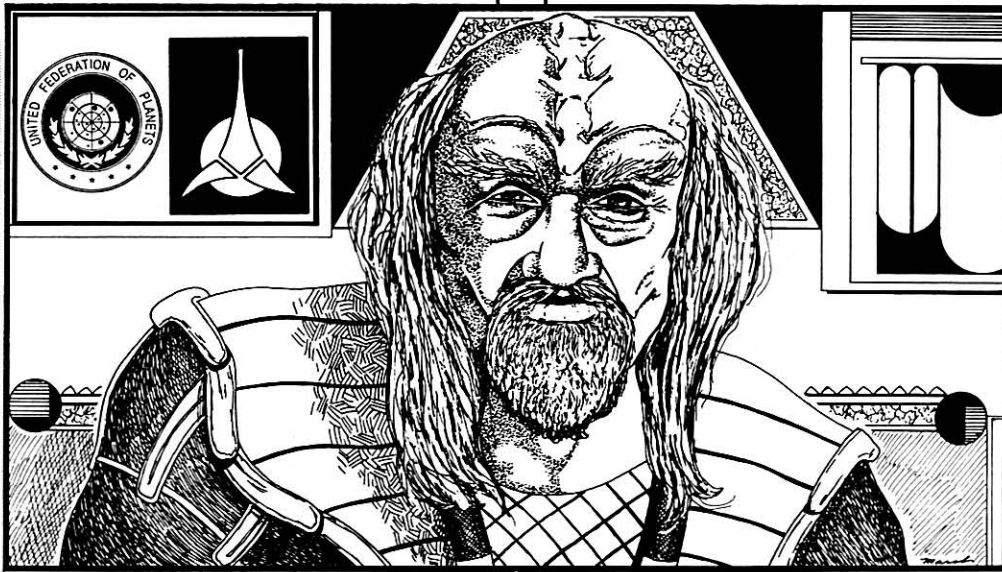

### LOCAL RULE

Local rule is the fourth stage in the typical Klingon development of a servitor world. In this phase, local government is in the hands of native leaders, who are responsible for meeting quotas and goals set by the Klingon Empire. Many servitor worlds never attain local rule, as it is granted only to those populations with a long record of cooperation with their Klingon masters under military and, later, civilian Klingon leadership.

### MIDSHIPMAN

*Midshipman* is the Galacta term for a Klingon naval officer's rank during the cadet cruise. Klingon Midshipmen (unlike their Federation counterparts) wield real authority on their cadet cruises, which tests their ability to command respect and inspire loyalty among the crew.

### MILITARY GOVERNORSHIP

Military governorship is the second stage in the Klingon development of a servitor world. In this phase, a Klingon military leader in charge of a medium-sized peacekeeping force controls all aspects of a planet's government. The length of time the world remains in this stage varies according to the cooperativeness of the servitor race and the efficiency shown by local agencies.

### MILITARY OCCUPATION

Military occupation is the first stage in the Klingon development of a servitor world. This phase begins with the initial subjugation of the planet and ends when a military governor and a smaller peacekeeping force replace the combat forces. The leader of the occupation force often (but not always) controls the appointment of the military governor. (Many appoint themselves or trusted members of their line.)

### NEUTRAL ZONE

This small UFP/Klingon border area that lies between Orion space and the Triangle is known as the Neutral Zone. The Organian Peace Treaty does not cover this area, which both the UFP and the Empire consider to be a 'no-man's land'. Warcraft of both sides patrol the area heavily.

### ORGANIAN PEACE TREATY

This treaty was negotiated between the Klingon Empire and the UFP after the Organian race used its formidable psionic powers to impose peace on them. The treaty created a large buffer zone along the UFP/Klingon border that extends up to the edge of Orion space. It also provided for the administration of all uninhabited worlds in the buffer zone and for the arbitration of Treaty Zone disputes between the UFP and the Empire. The treaty requires that all bases maintained in the zone be non-military, with facilities open to any spacefaring culture that requests their use. (See *Organian Treaty Zone* below.)

### ORGANIAN TREATY ZONE

The Organian Treaty Zone is the region of space bordering the Klingon Empire and the UFP that was defined by the Organian Peace Treaty. The Organian Treaty awards uninhabited worlds within this zone to the power that demonstrates the ability to most efficiently develop the resources of the planet.

### PAX ORGANIA

The Pax Organia is another name for the peace terms that the Organians imposed upon the Klingons and the UFP.

## "Nal Komerex, khesterex."

### PROTECTORATE

The Klingons define a protectorate as a planet or culture that is subject to their direction without becoming a servitor race. Protectorate status varies from worlds paying mere lip service to Klingon mutual protection treaties (as did the Orion Colonies early in their relationship with the Empire) to those that are little better off than servitor worlds (where the Klingons impose taxes, conscript troops, and otherwise manipulate the people without actually occupying the planet). Though some worlds occasionally request protectorate status, it is usually only under duress (for example, a non-spacefaring culture threatened with imminent Klingon orbital bombardment).

## QUADRANTS

As the early Klingon Empire began to expand, the space extending out from the Klinzhai homeworld was divided into four quadrants. The quadrant borders were drawn arbitrarily and somewhat inexactly, but they exist to this day as rough political divisions. One line is drawn through Klinzhai, extending coreward into infinity. The other dividing line was arbitrarily drawn through Klinzhai at a 90-degree angle to the first, extending infinitely in both directions.

It is believed that, for security seasons, the officially known borders of the quadrants do not actually pass through the Klinzhai star system. Instead, they pass through a similar system an unknown distance away from the true Klingon home planet.

## REGENT

The Regent is the Klingon who controls the day-to-day operations of the Imperial Throne and speaks "in the voice of the Emperor" when the Emperor himself is away from Klinzhai for a long period, or during a time when there is no seated Emperor. A Regent who acts for a seated, living Emperor is called a "temporary Regent" because the Emperor intends to return to resume his throne. Some temporary Regents, however, have gone on to become interim Regents after the death of the distant Emperor, and even to be seated as Emperors by the Imperial Council. A Klingon Emperor who leaves a Regent in control of the throne for too long is courting disaster, however.

## SPECIALIST

Specialist is a generic Klingon title for an individual holding a position requiring technical expertise.

## SQUADRON

A squadron is a small group of Klingon war vessels, combined under a single overall commander. The exact size of a squadron varies with the type of ship involved, but three vessels is the most typical number of vessels. The head commander is designated as "Squadron Leader", which is a title, not a rank.

## THOUGHT ADMIRAL

A Thought Admiral is a fleet grand strategist. Though he is in direct command of no naval vessels, a Thought Admiral stands, theoretically, at least, above all other naval officers in matters involving long-range planning.



## THE KLINGON LANGUAGE

—by Dr. Janson Leland, Department of Xenolanguages,  
Star Fleet Academy

Though the term "Klingonese" is widely used in the UFP, it is not the correct name for the Klingon language. In truth, a *number* of languages are in use in the Empire, and are known collectively as *Klingonaase*, which means, roughly, "the speech of the Klingon people". (The double-a construction in the word *Klingonaase* is pronounced nasally, halfway between the English/Galacta *a* of the word *ace* and the *e* of *easy*.)

The complexities of this series of languages is beyond the scope of this work. Instead, this volume will attempt to explain some of the peculiarities most likely to affect a Star Fleet officer when dealing with Klingons. Those wishing to study the language further should consult *The Klingon Dictionary* by Marc Okrand.

## VARIATIONS

Although a linguist might elaborate on each of the myriad dialects and sub-tongues, this volume will focus instead on certain differences between Imperial *Klingonaase* and the variants most often spoken by active Klingon military personnel.

### Kill, Dead

The layman may be surprised to learn that Klingons rarely use the *Klingonaase* verb *hoh* ("to kill"). The preferred construction is "to make dead", a subtle but important difference. A living, thinking organism (even an animal) cannot kill except by accident, for the term *kill* implies removal through the action of fate. It would only apply to a deliberate action if that act were especially casual. Applied to a person (as in the phrase "go kill him"), it implies that no value is placed on the killing.

The term *kh'ex* is a slang term meaning "dead" or, more generally, "nonfunctional", and almost exclusively refers to a deliberate act of killing. The derivation of this term is tied closely to the Klingon concept of an empire as a growth structure. See the next entry for details.



## KLINGON EMPIRE

The *Klingonaase* term for the Klingon Empire is *Komerex Klingon*, but the word *komerex* has a broader meaning than the English/Galacta word "empire" would indicate.

Students of Klingon trivia will recall that, at first contact, the Klingons referred to the Federation as an Empire, *i.e.*, they used the same word for both.

The word *komerex* means "the structure that grows". Its counterpart/antonym is *khesterex*. All societies are described by one of these two words. *Khesterex* cultures are, by definition, *kuve* (servitor races). There is no Klingon concept of an equilibrium culture, "Zero Population Growth", etc. If a society is not growing, it *must* be dead.

*Khex* (or *kh'ex*) is a slang term for "corpse", analogous to the human "stiff" or "flattiner", and is used in general for anything non-functional.

[NOTE: The authors are seeking funding for a sociolinguistic study of the enormous array of terms for things that do not work: the Rigellian/Orion "discount goods", the Tellarite *quat* (literally, "tastes lousy" or "inedible"), the Andorian *bouf* ("pink"), and so on. Only the Vulcans have no such word—apparently on Vulcan everything always works. We disallow the famed "illogical", because something may be illogical and still work. This study, when completed, will be entitled *A Bushel of Lemons*.]

—From *An Informal Guide to the Klingon Empire*



## MILITARY SALUTATION

Klingon military officers use the word *zan* as "mister" is used by Star Fleet—as a non-sex-specific term of address for an officer. In Star Fleet, a commander might call the first officer "Mister Jones" in direct address (whether Jones was male or female). The term might also be used informally and non-specifically. ("This trouble board had better be green when I get back, Mister, or you're in big trouble!") It is never used for the commanding officer of a vessel in space, however (always "Captain Smith", never "Mr. Smith").

*Zan* is used quite similarly. A Klingon would never use the term when speaking to a commanding officer. Nor is it sex-specific. Unlike the English/Galacta equivalent, however, *zan* is *always* combined with a specific name. (It is correct to say "Pick up that wrench, *zan* Korag!" It would not be correct to say "Pick up that wrench, *zan*!", as if one were saying, "Pick up that wrench, Mister!")

## BATTLE LANGUAGE

Battle language is a contracted form of *Klingonaase* used for rapid, precise commands in combat situations. It is also known (though rather imprecisely) as "clipped Klingonese". When a speaker is excited, in a hurry, or being extremely informal, he will commonly revert to these shortened forms.

Battle language sounds perfectly natural to a native speaker, but may be difficult for a person who learns *Klingonaase* as a second language. Battle language omits most pronominal prefixes, verb tense indicators, and other indicators, leaving just the raw forms of the nouns, verbs, and adjectives. In context, the meaning is clear, if the listener has grown up speaking *Klingonaase*. Others may have difficulty reasoning out the meaning, even if they have an extensive *Klingonaase* vocabulary.

[NOTE: Though the editor speaks *Klingonaase* quite fluently for a non-native, she finds it virtually impossible to properly pronounce a phrase in battle language without a snarl, and so extensive use of it produces a severe sore throat. Most native speakers would simply not understand battle language spoken in softer tones, which may indicate that harsh inflection is crucial to its use. The old joke about how "a smiling Klingon is a contradiction in terms" may be accurate to that extent.—SBJ]

The compressed forms of battle language are not suitable for subtle conversation. Because the proper subject/verb/object indicators are absent, the speaker would be unable to use it to communicate more complex ideas. Thus, it is normally used only for commands, quick explanations, and familiar phrases. One might use battle language to say "Fire torpedoes!" or "I need help!", but rarely for more complicated sentences requiring multiple nouns or lengthy instructions. As a rule of thumb, battle language can often be used to tell someone to do something, rarely to tell someone how to do it, and almost never to tell someone why.

## KLINGON EPITHETS

If one is to deal with Klingons, a command of insult form is a must, if only to know when one has *been* insulted.

The Klingons' favorite derisive term for many members of the Federation is "Earther" (or the *Klingonaase* equivalent, *urtal'anda*, meaning literally "big man of Earth"). They apply this term to virtually any member of the Human race, whether or not the individual was actually born on Terra. (It would not be used for Humans who vary greatly in appearance from Terran Humans, such as the golden-skinned natives of Heliantis IV, who are 100 percent Terran-spawned Humans, despite the unusual coloration caused by certain chemicals in their water.) The name is more insulting than it sounds, as the "big man" translation implies that Terra dominates the Federation. Such willing acceptance of domination is an intolerably insulting idea to a Klingon.

Klingons both respect and despise Vulcans. Though they grudgingly acknowledge Vulcan technological accomplishments and stoic lifestyle, Vulcan pacifism and vegetarianism is anathema to Klingons. Thus, a Klingon may publicly denounce a Vulcan, but he will rarely underestimate one. Vulcans are often called "leaf-eater" (*flansopra*) and "calculating machine" (*d'walsk*), but Klingons are aware that they can trust what a Vulcan tells them because of the Vulcan reluctance to tell a direct lie. Lying is, in some respects, a Klingon way of life, and so the Vulcans' compulsive truthfulness can be unnerving. Klingons will take advantage of it whenever they can, however.

The Klingons now classify the fierce warrior culture of the Andorians as *khesterox*, because Andor accepted membership into the Federation without fighting to the last for their independence. Klingons see Andorian moves toward

the other hand, Vulcans were not intended as conquerors, and so may serve honorably. The distinction is subtle but important. At any rate, to call a Klingon a "willing slave" is an insult that can only be cleansed by bloodshed.

Remember that traditional insults from other cultures may not translate well into *Klingonaase*. "Your mother wears army boots", for example, would translate as "Your maternal parent wears the footgear of a soldier". A Klingon would probably take this as a compliment, not an insult. References to the legitimacy of one's birth are also wasted on Klingons, due to differing customs of marriage/mating.

It is also difficult to insult a Klingon by calling him ugly, at least in his own language. There are two *Klingonaase* words for ugly. *G'nas* means "unattractive for mating", and has no meaning when applied between members of different species. On the other hand, *kaz'thaldim* (used to describe someone who was burned, scarred, or otherwise facially damaged) literally means "facially experienced". This is no insult, and many Klingons would take it as a compliment. To a Klingon, battle scars are marks of glory.

Insults are an artform among Klingons. The best insults are those implying derision through exaggeration or understatement (in other words, sarcasm). A common example would be to apply a lofty honorific or title to one who had not earned it. Addressing a Klingon Lieutenant as "Captain" while reading him the riot act for failing in his duty would be a devastating blow to his ego. It would be worse to call him "General", as the Naval services traditionally consider the ground forces to be an undisciplined bunch of amateurs (and vice versa).

Klingons do not seem to understand the concept of puns, probably because the structure of *Klingonaase* does not lend itself to the double meaning.



## "Know that all things done before the naked stars are remembered."

peace as weakness in a previously respectable warrior race. Thus, an Andorian may often be the butt of the ultimate Klingon insult, that of "willing slave".

The concept of *slave* is different from the Klingon *kuve*, or servitor. There is no shame in being a servitor to the mighty Klingon race, but one who serves when it was his destiny to conquer is beneath contempt. The Klingons believe that the Andorians have moved in this direction. On

The Klingon who can deliver a subtle insult in English/Galacta is rare. Most Klingons prefer the more direct approach of picking a bar fight (usually with a heavy mug of ale or a chair leg applied as punctuation). The Star Fleet officer who can deliver a complicated and devastating insult in *Klingonaase*, however, is rarer still. Perhaps, all things considered, that is just as well.

# THE KLINGON EMPIRE

## TIMELINE

This timeline was compiled by the Star Fleet Historical Research Section to highlight the major events in Klingon history. The information was drawn from many sources, especially records captured during the Four Years War and Klingon historical records reportedly examined by Emanuel Tagore.

### **Stardate ca.-28**

If Preserver theory applies to the Klingons, it is about this time that the Preservers would have seeded the Klinzhai system with the primitive race that will one day become modern Klingons. At present, however, no evidence exists to show that the Klingons did or did not come from Preserver root stock. The question is still open.

### **Stardate ca.-6/99**

According to a theory advanced by Tagore and Ford, a split between sea-dwelling and land-dwelling Klingons occurs at this time, perhaps forming the root for certain modern-day rivalries between Klingon Naval and Marine personnel.

### **Stardate ca.-4/82**

The earliest known Klingon literature, a crude epic poem about a great war, is composed. The poem tells of the conflict between the *komerex Nevre* (Northern Empire) and *falgav a'kavna* (Crescent Islanders). According to the poem, wars raged between these two groups for decades before the Northern Empire swallowed up the Crescent Islanders. Then, the poem relates, a series of conflicts with the *komerex Klingon* (Empire of the People) began, which lasted "for a thousand times a thousand nights". This is the earliest known reference to "the Klingon Empire".

### **Stardate ca.-1/01**

According to Klingon oral history, the Northern Empire develops "the terrible heat/death" (possibly nuclear weapons?), and then attacks the capital of the Klingon Empire at this time. Instead of being defeated, the Klingons of the capital unite in outrage and hatred for "the act of cowards, who raise a Great Cloud" to escape "the gaze of the naked stars". The "singular warriors of the Empire" counterattack and defeat the Northern Empire once and for all. In the end, it is the *komerex Klingon* (Klingon Empire) that controls the entire planet.

**"Every day is a good day to die."**

—Motto of the Imperial Marines

### **Stardate ca.-1/20**

Klingon literature and records of the period (discovered in captured bases during the Four Years War) first mention space travel at this time, and imply that the Klingons were able to colonize the planets and moons of the Klinzhai system. Specific records from this date up through the rise to power of the first Emperor are sketchy, however. It is known that there was a great rebellion, possibly involving a satellite colony, but there are no official records that such a colony ever existed. It is likely that history was 'revised' by the regime of Emperor Kahless to cover up an early failure or a major internal conflict.

### **Stardate ca.-1/90**

Kahless epetai-Riskadh becomes the first sole Emperor of the Klingon Empire, and he spearheads Klingon expansion efforts via warp drive.

### **Stardate -1/9403**

The first reliable records of Klingon enslavement of other races show the natives of the planet Delta Khinah II as Klingon "servitors". Based on Romulan records, it is believed that the Romulan Star Empire once held (or at least explored) this planet. Delta Khinah II may have been the site of the first Romulan/Klingon conflict.

### **Stardate 0/01**

Captured Klingon documents indicate that the Empire made first contact with the Romulans in this year. This led to a full-scale war lasting more than three years, with neither side gaining any major advantage when it finally ended.

### **Stardate 0/0306.15**

Emperor Kahless is killed in the final battle of the First Klingon/Romulan War.

### **Stardate 0/5807**

After a long period of unexplained idleness, Klingon conquest and exploratory efforts begin anew.

### **Stardate 0/7202**

According to Orion records, the Orion colonial governments make first contact with the Klingon Empire at this time. The Orions cleverly conceal the real value of their location in space and their mineral wealth, avoiding Klingon domination by convincing the Empire that they have more to offer as independent allies. The Empire assigns a figurehead governor to the Orion Colonies after a minor show of force, but he never actually attempts to exercise control, and his position is mostly that of a trade liaison. The average Orion is totally unaware that the colonies are 'officially' a Klingon protectorate. They do recognize a rich new market when they see one and so start trading with the Klingons. Meanwhile, the controlling Orion trade families are ever-watchful to assure that the Empire does not become *too* interested in Rigel's wealth.

### **Stardate 0/7610**

The Klingons withdraw their figurehead governor from the Orion worlds, beginning a period of benign neglect. With conflict heating up again between the Romulans and Klingons along their common border (though no war is ever officially declared), the Empire has no time for an area like Orion Space, which it perceives as only marginally useful. Trading vessels from the Klingon Empire become rare among the Orion Colonies, as most trade of war materials is now conducted using Orion vessels. This is allegedly done to free Klingon vessels for war efforts, but the Orions actually suggested the policy to rid their space of the Klingon presence so that they might build up their own military more effectively without tipping off the Empire to their actual strength.

### **Stardate 0/8706.06**

The founding members of the UFP sign the Articles of Federation, but the Rigel/Orion interests keep their colonies out of the Federation, avoiding restrictive entanglements for the time being. They also maintain the secret of the existence of the Klingon Empire. The Klingons are just one of many cultures the Orions trade with, and so go unnoticed by the Federation.

**Stardate 1/0003**

The ascendance of Keth epetai-Rivaki to the Imperial Throne begins a new era of Klingon expansionism and prosperity. Known as "the Centenarian", Keth lives to be just over 100 standard years old, and has the longest known reign of any Klingon Emperor.

**Stardate 1/0910**

With the end of the Romulan War, the Orion Colonies realize that the UFP and the Klingon Empire must eventually encounter one another. At present, the Klingon military is occupied with raids against the weakened Romulan border. The Orions fear, however, that the Klingons will soon turn their attention again in the direction of Rigel and her interstellar holdings. Realizing that any contact between the UFP and the Klingon Empire must inevitably lead to armed conflict, the Orions hastily negotiate several non-aggression and trade treaties with the UFP, but still do not join the Federation.

**Stardate 1/1818**

When the Klingons resume more active trading with the Rigel colonies, most Orion trade families shut down their operations with the UFP. Through masterful timing of ship arrivals, the Orions keep the Klingons and UFP unaware of each other's presence for many years, despite UFP displeasure at the closing of so many Orion ports.

**Stardate 1/2412**

Faced with threats that the UFP will revoke its non-aggression agreements because of the closure of Orion ports to even emergency traffic, the Orions reopen their ports to UFP shipping on a limited basis. They sign further treaties with the UFP, which promise the Orion worlds protection from outside aggression, while binding the Orions only to not *directly* attacking the UFP. This leaves the way open for the Orions to trade with both sides if and when the Klingon Empire and UFP ever meet in armed conflict.

**Stardate 1/3308**

It is believed that independent traders from the UFP first encounter Klingon traders on an Orion colony planet at or about this time, apparently as part of a drunken brawl in a spaceport bar. The merchant captain involved is E. A. Jacoby, an experienced trader with a small vessel. Having previously encountered any number of new races (all customers of the Orions) in past visits to Orion ports, he simply passes along the customary UFP contact material. Though Jacoby later claims to have filed the proper reports on this encounter to the UFP Contacts Bureau, those records are never found. A series of mysterious ship disappearances that begin soon after this incident may or may not be attributable to Klingon raids. It is known, however, that Klingon/Human genetic fusions existed at the time of the first confirmed meeting between the two races, and so it must be assumed that some earlier contact occurred, during which the Klingons took Human prisoners.

**Stardate 1/5101.18**

The independent trader *Millie Sue* and an unknown scout vessel exchange fire on this date. Though the *Millie Sue* damages and chases away the attacking ship, the exchange leaves her without faster-than-light travel capability. Two Star Fleet warships respond to the trader ship's distress call, and rescue all hands. A nearby destroyer-class ship of unknown configuration also evades the larger Star Fleet vessels. Later examination of the data points to the probability that both unknown vessels were of Klingon origin. The encounter leads the UFP to press Orion sources for information on this unfamiliar space-travelling race.

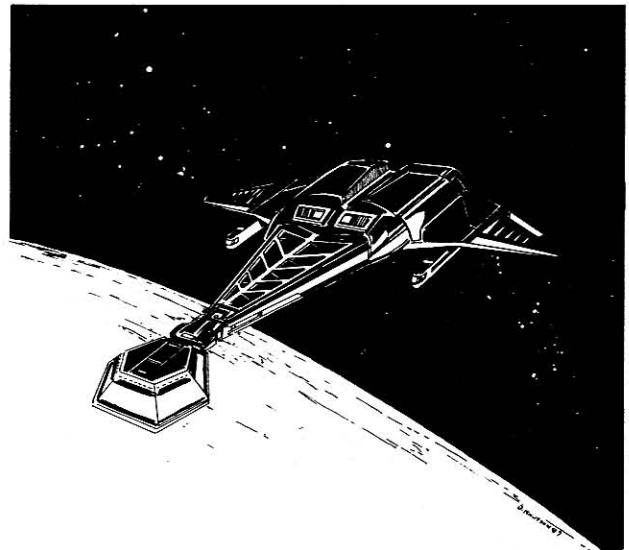
**Stardate 1/5105.02**

The *USS Sentry* encounters and confronts the Klingon cruiser *Devisor* near Gamma Demetrius. A brief exchange of fire marks the first official contact between the UFP and the Klingon Empire.

**Stardate 1/6003.04**

The *USS Flying Fortress*, a prototype slow transport, is hijacked in space by a Klingon war vessel. A Federation anti-piracy force intercepts the hijacked vessel as it is being towed away, forcing the Klingons to release their tractor beam and to flee. The badly damaged *USS Flying Fortress* is recovered.

**Stardate 1/6110.21**

Star Fleet disguises a number of warships as merchant vessels in a successful ploy to draw out the Klingon Empire for another attack. Two Klingon warships fire upon the *USS Phantom* without warning while she is proceeding (disguised as a large merchant vessel) in Orion space. The *Phantom* jettisons its dummy cargo pod and engages the Klingon attackers, destroying one and crippling the life support system of the second. A boarding party from the *Phantom* attempts to rescue survivors and to gather information, but the Klingons explode the ship to avoid revealing too much about themselves, killing all survivors and the rescue party. Without substantive evidence to link the attack to the largely still mysterious Klingon government, the UFP can take no direct military action.

**Stardate 1/8203-8703**

The Klingon military seems to turn its attention away from the UFP borders (and, if Romulan records can be believed, from their borders as well). Evidence points to Klingon Empire involvement in a war with other, unknown forces along their coreward border. Klingon fleets return to their UFP border areas in force after Stardate 1/8703.

**Stardate 1/9212.21**

The *USS Bohr* reports observing a three-ship Klingon task force in unclaimed space between the UFP and Klingon spheres of influence. The small task force is a decoy to lure the *Bohr* from its patrol area, so that a 20-ship Klingon force can attack the Arcanis research station. The massacre of 112 UFP citizens begins an inexorable chain of events leading to war. Two massive Klingon battle fleets are detected over the next two months, but open hostilities do not begin immediately. The UFP begins to organize for conflict.

**Stardate 1/9408.29**

Captain Garth of Izar defeats a fleet of Klingon reinforcements headed for the Axanar system, preventing the Klingons from establishing a supply line to forces already massed there. Unaware of the results of the First Battle of Axanar, the Klingon Empire declares war on the UFP exactly one month later, on Stardate 1/9409.29. At the Second Battle of Axanar, Garth (his small command now reinforced by Star Fleet) defeats the Klingon invasion fleet at Axanar.

**Stardate 1/9704**

Forces of the Klingon Empire make their deepest penetration into Federation space at the Battle of Thranstor, but the Klingon fleet under Admiral Kamato is eventually routed by a reinforced Federation fleet armed with the new phaser weapons.

**Stardate 1/9709.10**

After his attempt at coup d'etat fails, Admiral Kamato flees to the Triangle, where he founds the Imperial Klingon States. Declaring itself the "true" Klingon government in exile, the IKS becomes a major source of intelligence against the Klingon Empire for the rest of the war.

**Stardate 1/9712.06**

The UFP captures Klingon Admiral Komex, who informs them of the location of the two major Klingon supply bases in the disputed area.

**Stardate 1/9803.20**

In the Battle of Kolm-an, the UFP deals a crushing blow to Klingon supply and repair capability, forcing the Empire to sue for peace.

**Stardate 1/9806**

The Four Years War ends with the signing of the Treaty of Axanar. Admiral Komex refuses the UFP offer of asylum, and instead returns to Klinzhai after the war as part of a prisoner exchange program. He is never heard from again, nor will Klingon sources ever again acknowledge his existence.

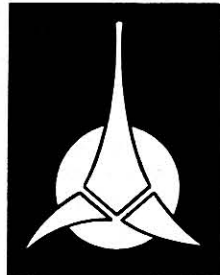
**Stardate 2/0109**

Completion of the new Klingon Naval base at Mastocal marks the Empire's return to a prewar level of battle readiness. By Stardate 2/0706, the Klingon Navy is again making aggressive moves in the border areas.

**Stardate 2/04**

Federation and Klingon forces clash along a wide expanse of space claimed by both sides.

**Stardate 2/0801**

Klingon ground and space forces mount a successful attack on the planet Organia. Star Fleet anticipates the attack, but a change in the invasion timetable traps the *USS Enterprise* in Organian orbit and strands two of her officers on the surface when the attack comes. Captain James T. Kirk and his Vulcan First Officer Spock mount a valiant resistance, despite a lack of aid from the Organian people or their government. Even so, they are finally captured by Klingon military governor Kor. Meanwhile, a UFP relief fleet (led by the escaped *Enterprise*) returns to combat the Klingon forces.

The Organians suddenly drop the illusion that they are a Humanoid lifeform to reveal themselves as enormously powerful energy beings. Using their mental powers, the Organians render both the Klingon and UFP fleets helpless in space, and then use the force of their will to impose peace on the combatants. Not long after, the Organian Peace Treaty establishes the Organian Treaty Zone between the Empire and the UFP. The treaty provides for restraint of hostilities in the Treaty Zone area, with the Organians awarding undeveloped worlds in the Zone to the government that proves itself most able to develop the world efficiently. Klingon efforts at conquest ebb in favor of more subtle (but no less dangerous) intrigue and sabotage.

**Stardate 2/0911**

Deep-cover Star Fleet agents within the Klingon Empire report that the Klingons and Romulans have settled their border disputes and have likely sealed cease-fire agreements with military technology exchanges.

**Stardate 2/2107.16**

Admiral Randolph Morrow informs all Star Fleet vessels that "according to information obtained by the highest levels of Star Fleet Command, the race of energy beings referred to as the Organians have ceased their enforcement of the Organian Peace Treaty." Apparently, the Organians will no longer intervene in any actions between the Federation and the Klingon Empire. This means that war is once again possible.

**Stardate 2/2206**

Using a Romulan-design vessel equipped with a cloaking device, Lord Kruge manages to penetrate deeply into Federation space. He has learned of the Federation's new Genesis Device and pursues it to the Genesis Planet. He is killed there and his ship captured and taken to Vulcan by Captain James T. Kirk of Star Fleet. The Empire officially denies all involvement with Kruge's mission.

**Stardate 2/2209.26**

Kiltarc zantai-Neygebh, Klingon Ambassador to the Federation, arrives on Terra. He demands that Captain James T. Kirk be delivered to the Klingons, to be tried as a pirate and interstellar criminal for his role in the Genesis Incident. The Federation Council refuses, saying that Kirk is subject only to Federation jurisprudence.

**Stardate 2/2210.14**

Captain Kirk and the crewmembers involved in the Genesis Incident are court-martialed for the spacejacking and subsequent destruction of the *USS Enterprise*. The Court exonerates Scott, Sulu, Uhura, McCoy, and Chekov, but sentences Kirk to formal chastisement and a two-grade demotion to Captain.

**Stardate 2/2210.17**

Klingon Ambassador Kiltarc abruptly leaves Terra and returns to the Klingon Empire.

## KLINGON HOME SYSTEM

The United Federation of Planets does not know the exact location of the Klingon home system, even though a small handful of UFP representatives and members of Federation races have been to Klinzhai and returned to tell of it. All visitors to Klinzhai have gone there via Klingon Imperial vessels, either as prisoners or as diplomatic representatives. Though it might be possible to deduce Klinzhai's location from the time it takes to get there, no 'visitor' has ever known at what speed his transport vessel was traveling.

Of all the UFP races, the Vulcans know the most but tell the least about Klinzhai. Most of the existing confirmation of UFP speculations about the planet have come from the Vulcan Science Council, however. Presumably, the Vulcans have had observers within the Klinzhai system for extended periods on numerous occasions. The exact nature of these contacts is still a Vulcan state secret, despite the best efforts of the UFP to obtain records for study by other Federation races. UFP laws protecting the security and privacy of member cultures guard the secret of Vulcan/Klingon relations.

One of the earliest known Human visitors to Klinzhai was Dr. Emanuel Tagore, whose notes on the Klingon Empire formed the basis for the findings of the Committee on the Klingon Estimate (a UFP study group) and the popular book, *An Informal History of the Klingon Empire*, co-authored by J. M. Ford. Much of what we know of Klinzhai was first revealed in Tagore's works and later confirmed by other sources. An excerpt from *An Informal Guide to the Klingon Empire* is included here, along with the current system information bulletin about Klinzhai in use by Star Fleet.

### LIFE AND CIVILIZATION LOG: KLINZHAI

<b>Code:</b>	999983-76
Dominant Race:	Klingons
Life Form:	Mammalian
<b>Technological Index</b>	
Space Science Index:	9
Physical Science Index:	9
Engineering Index:	9
Planetary Science Index:	9
Life/Medical Science Index:	8
Psionics Index:	3
<b>Sociopolitical Index</b>	
Social Science Index:	7
Cultural Attitude Index:	6



### World Log: KLINZHAI

#### System Data

<b>System Name:</b>	Unknown (Referred to as "Klinzhai's Star" in Klingon records)
Map Coordinates:	Unknown
<b>Number of Class M Present:</b>	Unknown

#### Planetary Data

<b>Position In System:</b>	Unknown
<b>Number of Satellites:</b>	No moons mentioned in Klingon literature
<b>Planetary Gravity:</b>	Approx. 1.5 G (based on Klingon physiology)

#### Planetary Size

Diameter:	19,500 km
Equatorial Circumference:	60,000 km
Total Surface Area:	768,000,000 sq km
Percent Land Mass:	Estimated at 30%
Total Land Area:	230,400,000 sq km

#### Planetary Conditions

Length Of Day:	Approx. 28 hrs
Atmospheric Density:	Terrestrial
General Climate:	Tropical

#### Mineral Content

Normal Metals:	Unknown
Radioactives:	Known to be present
Gemstones:	Unknown
Industrial Crystals:	Known to be present
Special Minerals:	Unknown

Complete scientific data on the Klingon homeworld of Klinzhai are not available; in fact, the Federation still does not know the precise location of Klinzhai. However, the following composite portrait may be deduced.

Klinzhai's star is brighter and hotter than Sol, perhaps an F7 or F8 spectral class. The orbital distance is longer, making the primary an intense pinpoint of light, capable of causing blindness if looked at even briefly.

However, Klinzhai is almost totally shrouded in clouds. Neither the primary star nor any others are often visible on Klinzhai. There is evidence that Klingons see a starry night sky less than one night in a hundred. As might be expected, "the naked stars" are an object of reverence, even awe, in Klingon culture. There is a belief that any act carried out beneath the visible stars has special significance. This helps to explain the dominant role of the Navy, whose members spend their lives among the naked stars.

The planetary cloud blanket creates a pronounced greenhouse effect. Mean temperature is some 15° C. above Earth's, and global humidity is very high. Klinzhai is reportedly quite lush, with extensive forests, jungles, and swamps and no deserts. The Klingons have exploited their oceans, but have ignored the polar caps (except, perhaps, as military reservations).

Klinzhai's day is somewhat longer than Earth's, and the year is about 10 percent longer than the Federation standard year (solar year). The year is not divided into months. Though there are "hot" and "cold" seasons, these terms are misleading, because the annual variation in temperature is small. There is snow only at the highest latitudes.

The literature of Klinzhai does not mention a moon, which means that the planet's oceans are subject only to the weak solar tides. This fits with the speculation that life evolved in the oceans, perhaps to the fringes of intelligence.

—From *An Informal Guide to the Klingon Empire*

## KLINZHAI

Klinzhai is perhaps the best-defended planet in the known galaxy, with the Klingons' natural distrust and paranoia at its peak when defending their homeworld. This is only natural, as Klinzhai itself is the hub of Klingon civilization and the seat of its government. Visitors to Klinzhai (and there have been few from UFP worlds other than Vulcan) almost never are allowed to leave the port city of Aval on Klinzhai's main continent. The seat of Klingon government is elsewhere, at New Khal City, with the Imperial Residence an unspecified distance away and never visited by 'aliens'.

Klinzhai's planetary defenses include a huge network of manned and unmanned defense satellites. These orbital stations, similar to those around most Klingon colony worlds but much larger, are each capable of fighting off a small fleet. They are apparently powered by antimatter generators, which makes them useful as defense against spaceborne invasion and also as a check on the Klinzhai population. (Who would revolt, with a chain of the universe's biggest bombs orbiting overhead?)

According to Tagore and other visitors to Klinzhai, its oceans are more fully developed than those of most planets of the Federation. There is frequent mention of undersea farming in Klingon literature, and a disproportionate number of Klingon fighting men seem to have extensive knowledge of underwater demolitions, seamanship, and such pursuits. It is known that Klinzhai is one of the few homeworlds of a technological civilization that actually *exports* more food-stuffs than it imports! (Most of these exports, however, are edible algae and kelp-like plants destined for *kuve* worlds.)

Another product of the Klinzhai seas is *fe'gli*, a rare seaweed-based herb that is apparently a prime ingredient in preparations that have an aphrodisiac effect on most mammalian bipeds. Klingon aphrodisiacs have a galaxy-wide reputation, though it is unlikely that many individuals in the UFP have ever really seen (let alone ingested) any of these preparations. Even so, it is known that some *fe'gli* is exported (mostly through Orion brokers). Drugs based on the herb are extremely dangerous, as well as illegal throughout the Federation.

Some might say I was lucky to have been spared the wrath of Klingon "justice" in the field and taken instead to the Klingon homeworld for interrogation. More than once I counted as lucky those of my comrades who had died in battle or even under interrogation. Cruelty is a concept the human mind cannot imagine to the fullest until one has been to Slivi, the Klingon penal colony on Klinzhai.

I lived for seven months in the depths of Hell itself; in the mines where, surrounded by wretched sufferers of a hundred non-Human races, only the most valued prisoners were allowed to come to the surface but once a day. That one sight of Klinzhai's cloudy, murky sky each day as I marched to the surface interrogation facility might have seemed totally dismal to anyone else. To me, it was the one clear breath of almost-freedom before the pain and madness began again. I never walked back to the mines. I simply woke up there after my nerves rejected the day's tortures and returned me to consciousness.

## SLIVI

The Klingons maintain a penal colony on a remote island continent, whose existence was revealed by Colonel Leland Q. Schuyler-Grant, the only man ever to return from it. While still a Second Lieutenant, he was captured in a ground action during the Four Years War. Schuyler-Grant was taken to Klinzhai as a prisoner of war because the Imperial High Command believed (erroneously) that he was one of the top advisors to the UFP Ground Forces Command. In reality, Schuyler-Grant was disguised as a general and carrying phony war plans as part of a disinformation effort by the UFP Intelligence Command.

When Schuyler-Grant volunteered for the dangerous assignment, Vulcan experts trained him in pain-blocking techniques and other means of resisting drugs and torture. The plan went awry, however, when he was captured while trying to pass the false documents to a known Klingon agent. Knowing that he would be killed immediately if his true rank and status were revealed, Schuyler-Grant continued to masquerade as a prisoner of war, enduring torture and imprisonment while feeding false data to the Klingon High Command.

After the war, he returned home as part of a prisoner exchange, with the Klingons still unaware that he was not a general staff officer. He was decorated and promoted, then served as an advisor on Klingon psychology for eight years before his death from complications of breathing radioactive dust during his ordeal. Following is an excerpt from the introduction to his memoirs, a remarkable volume.

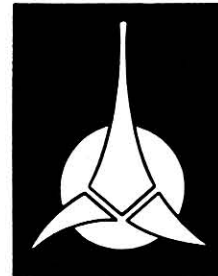

For seven months, I slaved, breathing the radioactive dust that I knew was accumulating day by day in my lungs. I saw my companions die of it, or of the little "amusements" dreamed up by our Klingon jailers. The guards themselves were condemned to this place, and so they took out their hate on the non-Klingon prisoners. Those visions haunt me still.

I watched the Vulcan Staku (a prisoner taken in a raid on a peaceful science station) die bit by bit, deprived by our diet of algae and sea offal of the trace nutrients essential for the health of his kind. His great strength and endurance faded day by day, but not his stoic belief that one day rescue would come. The war ended and prisoner exchange was arranged for Staku and myself, but not in time. The raw uranium dust took its toll and he finally died of malnutrition and massive tumors in his lungs just two days before our release. It is to him, and all the other victims of Klingon cruelty, that I dedicate this work.

—From *In the Presence of My Enemies*, by Colonel Leland Q. Schuyler-Grant, *Star Fleet Marine Corps*

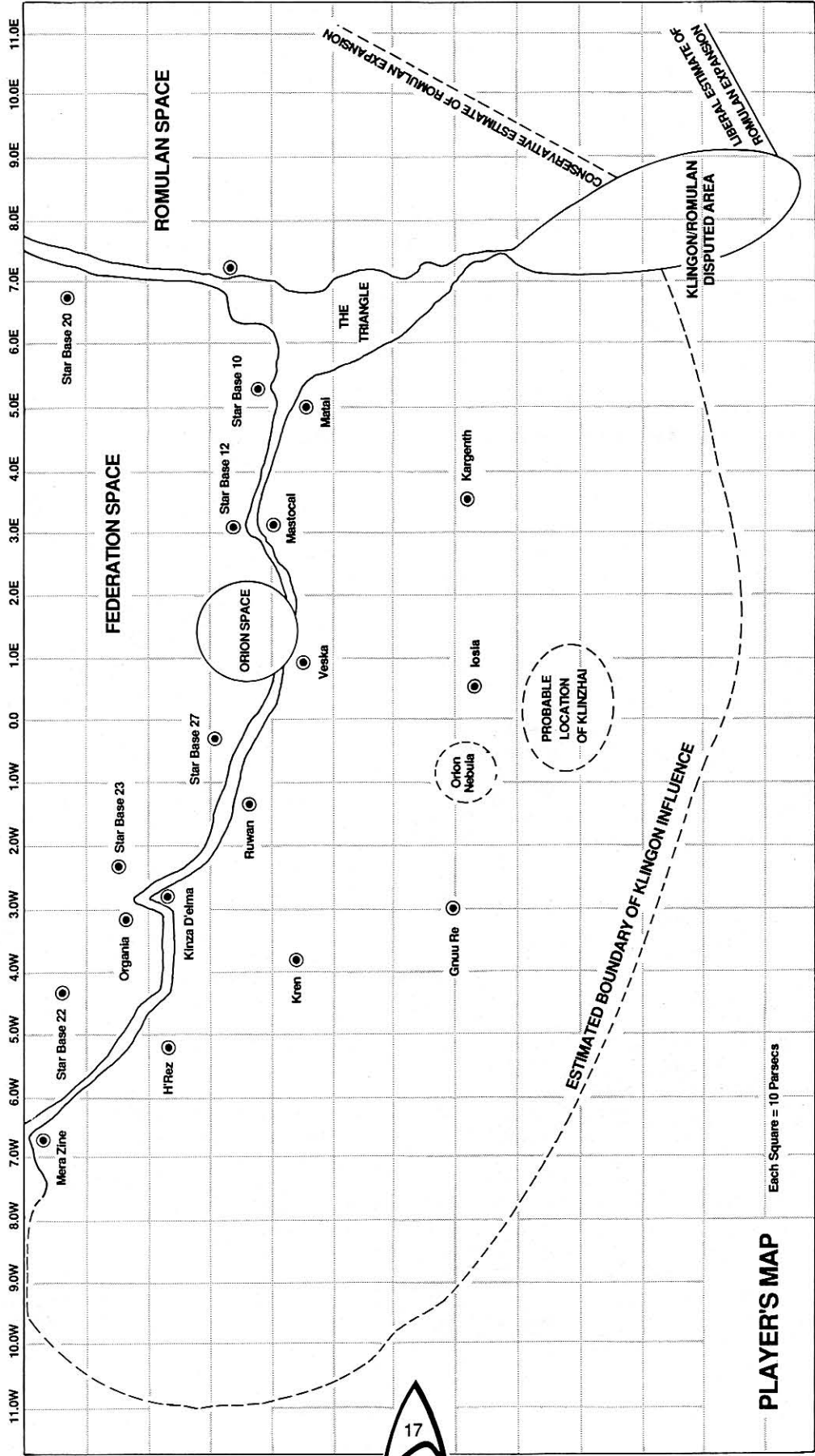

## EXTENT OF THE EMPIRE

Though the exact size of the Klingon Empire is not known, the map on page 17 shows a rough estimate. The exact location of the Klingon home system remains unknown, too, even though a few Federation citizens have been there at one time or another as diplomats, observers, or prisoners. The Klingons have always made all the travel arrangements for these visitors, apparently taking great pains to conceal the location of Klinzhai. Based on travel time estimates and messages intercepted in the Four Years War, however, Federation scholars guess that the home system is located galactic south of the Organian Treaty Zone, but that the true location may deviate from this by as much as 20 parsecs. That is a very large area in which to hide one small star system.

### ORGANIAN TREATY ZONE

The Organian Treaty Zone is the major boundary between the Klingon Empire and the Federation. The Organians enforced the peace here for some time, though recently they have apparently ceased to do so, which means that war between the Klingon Empire and the Federation is once again possible. The Federation has been building star bases and outposts in the area to ensure peace, should the Organian-imposed truce ever break down. The theory is that the Klingons are doing the same, but with more concentration on the Neutral Zone instead. In the Neutral Zone, they do not have to be concerned about Organian Treaty regulations.

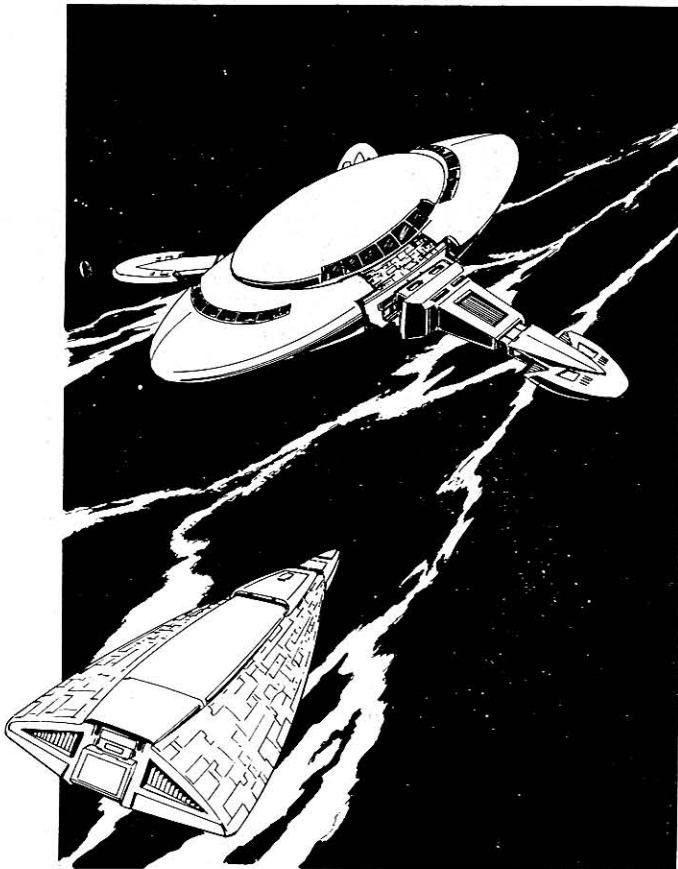

### KLINGON NEUTRAL ZONE

This small border area gives Federation officers their most sleepless nights. The Klingons attack almost at will in this region, which does not fall under the protection of the Organian Treaty. These attacks consist mainly of minor border incidents between patrolling ships, however. The fact that the Federation maintains a large force in the region is certainly one deterrent to all-out war. It is also possible that the Klingons fear an attack by Romulans on another border if they get too busy fighting the UFP.

### KLINGON/ROMULAN BORDER

The Klingon Empire borders the Romulans along a large stretch of space, but the length of this border remains unknown. In an earlier period, the border seemed to shift back and forth quite a bit as the two Empires fought for control. More recently, however, technological exchange agreements have put an end to most open warfare. Recent information now filtering back to UFP intelligence seems to indicate that the possibility of a major conflict along this border has now reared its head again.

### TRIANGLE HOLDINGS

The Klingon Empire seems firmly entrenched along its edge of the Triangle. Intelligence gathered by free traders operating with UFP agents in the area indicates that the Klingons are building up for a push to totally control the southern third of this region. The Klingons have openly supported several revolutions in the Triangle, particularly the battles in the Mantiev Colonial Association. (One positive benefit of the MCA war is that UFP agents have been able to gather extensive data on the Klingon war machine.) Should the Klingon-supported forces manage to secure a victory against those supported by the Romulans in the Mantiev area, it could force the Romulans to further intensify their military presence in the Triangle. If current trends continue, many UFP observers predict that they will eventually lead to open warfare between the two Empires, with the Triangle as the flashpoint.

One of the puzzles of Klingon presence in the Triangle is the Imperial Klingon States, an area midway between the sections controlled by the UFP and the Romulans. The IKS claims that they do not answer to the Klingon Empire, but are ruled instead by a Klingon warlord. Many Federation grand strategists believe that the Klingons are using the IKS as a ruse to occupy the area in hopes of playing the UFP and the Romulans off against one another. It is difficult to imagine the Klingons allowing a splinter group such as the IKS to survive and expand. The stories about open conflict between the Empire and the IKS may be fabrications to keep the Federation off balance.

### THE UNKNOWN FRONTIER

There is some evidence that the Klingons have encountered or made contact with at least one other spacefaring group, whose origin and nature are unknown. It is speculated that the Klingons defeated them during an earlier war, and still maintain armed occupation of portions of their territory. This would account for some of the findings of Operation Dixie, as well as certain patterns of Klingon military force deployment in the past. Until warfare erupts again (if it ever does) between the Klingons and the Unknowns, this theory cannot be proved or disproved.

## INTERSTELLAR RELATIONS

### UNITED FEDERATION OF PLANETS

Relations between the Klingon Empire and the UFP have fluctuated between restrained hostility and outright interstellar war, a trend that is likely to continue in the coming years. Despite the best efforts of Federation diplomats, Organian energy beings, and others, the goals and cultural backgrounds of the Klingon Empire and the Federation are too much at variance for a true reconciliation ever to take place.

This is not to say that all negotiation with the Empire is doomed to failure. Though the Federation must keep the channels of communication open, it never expects an interface with the Klingon Empire to be without friction. Cooperation may be the central idea that holds the UFP together, but it is a concept almost totally foreign to the Klingons.

Conquest is as natural to them as breathing is to Humanity. If the little that is known about their homeworld of Klinzhai is true, intelligent life on that world could not have developed without an almost indomitable conquering spirit. Indeed, this helps to explain the Empire's past and present relationships with its interstellar neighbors.



**CURRENT CREW  
OF THE  
USS ENTERPRISE  
(STARDATE 2/2210)**



The costly Four Years War was an inevitable conflict, though many in the UFP still find it hard to accept that fact. Up until its encounter with the Federation, the Klingon Empire had never confronted an expansionist culture that was primarily non-violent. Their early encounters with the Romulans assured them (as did most of their history) that cultures either grow at the expense of others around them, or they die at the hands of someone or something stronger.

**"Mere life is not victory.  
Mere death is not defeat"**

—Motto of the Imperial Navy

With the memory of the Romulan War still fresh, the UFP recognized that it had met yet another enemy who seemed to prefer fighting to discussion. If the military response to the first Klingon skirmishes seems out of character with the UFP's peaceful ideals, it is well to remember that many leaders of what would become the Four Years War had lost loved ones in the war with the Romulans. Both sides were quite ready to fight.

During the course of the war, however, the Federation benefitted from tempering its military response with diplomacy and economic strategies. Indeed, it was the UFP's war relief efforts in the Triangle and along the border reaches that won it many friends during the war, bringing new allies into the Federation. Conducting the war also taught Federation commanders much about how their Klingon counterparts think and act. From leaders such as Admiral Komex, they learned that the Klingons are not mindless killers and conquistadors without conscience, but simply a race whose goals differ so radically from our own that war is a constant danger.

There were lessons for the Klingons, too. They learned not to underestimate the military preparedness of a culture apparently not predisposed to war. The Romulans had been an obvious threat to them, but the UFP 'threat' was subtler. The Klingons watched and waited, however, and eventually planned a different method of conquest.

In their second war with the Federation, the Empire's strategy changed. The Klingons now understood that the Federation's strength lay not just with Humanity and a few larger allied cultures, but with the diversity of experience the UFP could bring to bear on problems. This may be why they chose to direct their next assaults at a border area full



of smaller civilizations. By attempting to seize Organia and other key border systems, they may have hoped to whittle away at the UFP while creating dissension among its members about how to respond to the Klingon threat.

Their strategy might have had a chance. Though Star Fleet reacted swiftly and strongly to the Klingon occupation of Organia and the surrounding systems, once the Federation Council convened, its decision might very well have been to take a 'wait and see' attitude. The Council might even have been willing to sacrifice Organia and the border systems to gain time to arm and prepare the interior systems.

The Organian Intervention ended all speculation about massive fleet actions on the border areas. In truth, the Organians forced the UFP and the Klingon Empire to accept what the UFP *said* it wanted all along—a fair shake for native cultures and colonists alike. The fact that this satisfied the Federation so little reveals a bit of the conquistador still in it.

The Klingons proved their adaptability by adjusting their strategy in the Organian Treaty Zone much faster than did the UFP, however. According to the Treaty, planets would be awarded for colonization on the basis of efficient exploitation of resources. Like it or not, the Klingons are extremely efficient. They were able to act with one mind, while the UFP had to deal with the conflicting goals and priorities of many member civilizations. The Klingons, therefore, took an early lead in Treaty Zone colonization.

True to form, however, they eventually spent more effort attempting to sabotage the UFP than they did in supporting their own bids for colonies. Because of this, development of colonial properties in the Zone has split evenly between the two powers. With most of the inhabited worlds in the Zone also allying with or joining the UFP, the Klingons have lost a great deal of momentum in the area since the Treaty.

Recently, the Organians have retired from an active role in administering the zone. The Organians obviously hope that the two cultures can avoid war on their own, but a return to armed conflict may cause them to resume their active policing of the area.

It is said that Klingons negotiate best with a knife at their throats. If so, war will occur again, or the Organians will again have to interfere to prevent it. We must not always take the most simplistic view of Klingon society, however. Just as the Klingons learned much from the Four Years War, perhaps they have also learned from the war that never happened. They do not fight for love of fighting (at least not exclusively), but for *advantage*. Given that the stability of the current Treaty Zone has economically benefitted the Empire as much or more than the UFP, it is possible that they will look elsewhere for a place to beat the war drums.

### "Only a fool fights in a burning house."

—Klingon Proverb

If so, they may choose a spot in the small area of Neutral Zone still remaining between the Empire and UFP. The Neutral Zone seems to offer belligerent Klingon military leaders the perfect place to make the most noise while seeking glory in battle, as Lord Kruge did for years before he was killed in his recent desperate attempt to invade UFP space and to steal the Genesis Device. Such adventurism is mere saber-rattling, however. If it is true that the Empire fights for advantage more than for glory, then they have probably set their sights on the area neighboring the Neutral Zone, which is the Triangle.

This section of space has thrived over the years on the neglect of the Big Three interstellar governments. Much as the Terran nation of Australia grew strong on the outcasts of Great Britain, the Triangle has grown strong on outcasts from nearly *everywhere*. Once ignored because it was not rich in physical resources, the Triangle has grown very rich in economic and Human/non-Human resources.

For now, it is as much to the advantage of the Empire as to the UFP to allow the Triangle to remain a refuge from big government, but it may not always be so. On the day that the Empire sees advantage in owning the Triangle, they will reach out to take what they consider to be theirs by right, which is the Klingon way. On that day, the Federation must be ready to act as well.

### ROMULAN STAR EMPIRE

Klingon contact with the Romulans goes back much farther than Empire dealings with the UFP, though the UFP remained unaware of that history until much later. From what we know of the Klingons, they would feel compelled to combat the Romulans wherever encountered, as the Star Empire is a rival expansionist culture. With the exception of minor skirmishes, however, the Klingon/Romulan borders have remained relatively quiet in the last decade or so. In fact, recent revelations about the extent of Romulan/Klingon cooperation has confused many of the experts.

Klingons fight to gain clear advantage. Current Klingon/Romulan relations might, therefore, best be understood by the imperfectly translated Klingon proverb, "Only a fool fights in a burning house." The UFP threatens both empires much more than they scare each other, because the Federation is a wild card that does not fit within their narrow definitions of "how beings behave". To the Romulans, the UFP is chaotic and unpredictable. To the Klingons, the Federation is a contradiction in terms—a growing, vital culture that cooperates with other growing, vital cultures rather than devouring them. It is no wonder the two Empires co-operate to gain advantage against it.

There is little reason to fear a lasting Romulan/Klingon military alliance, however. Old grudges die hard for the Klingons, and they hated the Romulans long before they even knew the Federation existed. If there is any consolation in the recent Klingon/Romulan exchanges of technology, it is in how little they have accomplished. Klingon ships are better armed and the Romulan fleet is larger. As often as not, however, the two sides use these new capabilities to fight each other in border skirmishes that waste their strength.

The greatest danger to the UFP in the current Romulan/Klingon relationship is their sharing of intelligence, which allows them to anticipate the defensive strategies the UFP is likely to employ. Also, Romulan cloaking devices are a definite threat when used by Klingon spy vessels, as seen in Lord Kruge's recent deep-penetration mission into the Mutara Sector. Romulan subtlety and Klingon arrogance is a deadly mixture when combined in espionage.



## ORION COLONIES

The UFP/Klingon border skirts the neutral systems of the Orions, near Rigel. Though the Orions are comparatively weak, the Empire respects their neutrality, and even extends favored status in trade to the Orion systems, as well as travel permits within the Empire. Given that Klingons do nothing that will not bring them advantage, there must be more to this arrangement than meets the eye. Moreover, Orions are not known for making poor deals.

Many suspect that the continuing piracy against the UFP within Orion-held areas of space is as much the work of Klingon privateers as it is of Orion pirates. Whether or not Klingons are involved, however, the Empire can only profit from UFP merchant shipping losses in this area, and they know it. Still, the Orion trade families are powerful and useful allies of the Federation. The economic stability of Orion holdings is vital to UFP interests. For this reason, the Federation must not allow the Klingon Empire to gain too much influence over Orion governmental affairs.

## GORN ALLIANCE AND THE THOLIAN ASSEMBLY

To the best knowledge of the UFP intelligence community, the Klingons have not directly encountered or made agreements with either the Gorn or the Tholians. Indeed, the Klingons are not likely to have much knowledge of either group, given that the Romulans lie between the Klingons and Gorn, and that the bulk of the UFP lies between the Klingons and Tholians.

Even so, the success of deep-penetration missions like that of Lord Kruge means that the possibility of contact does exist. It is unlikely, however, that any contact between the Klingons and these two cultures would result in cooperation. The Gorn are too gruff and expansionistic and the Tholians too alien to relate to the Klingons as anything but enemies. One thing that the Empire cannot afford at this time is another starfaring enemy, and so they will probably not make any efforts to contact either group in the near future.



## THE "UNKNOWN"

Between Stardates 1/8200 and 1/8800, intelligence sources detected a massive move of Klingon military might away from the UFP and Romulan borders and back across the interior of Klingon space. The only logical explanation for such action is that the troops and ships withdrawn were needed elsewhere. The question is, why?

Most experts on the Klingon Empire speculate that during this time the Klingons were engaged in armed conflict with an unknown enemy. From data accumulated in the ill-fated Operation Dixie and its more successful counterpart within the Romulan sphere, Star Fleet Intelligence has established that this conflict was not one of the many border clashes between the Romulans and Klingons. In fact, the Romulan Star Empire seems unaware that the conflict ever existed.

Nonetheless, the evidence seems to show that some conflict distracted the Klingon High Command's attention from its two greatest rivals for a period of almost six Terran years. Did the Klingons have an unknown enemy? If so, did they eventually overcome them? The answer is probably yes. Intelligence reports estimate that the Empire still maintains a larger-than-average fleet in the area directly opposite their border with the UFP. Perhaps the Klingons captured a major block of territory in this Unknown War, and must now continue to occupy and fortify it to maintain control over the Unknown Enemy they conquered after a six-year struggle. If so, this Unknown Enemy could be a potential ally of the Federation should a UFP/Klingon war ever break out again. To learn more about this situation, priority should be given to more deep-penetration efforts like that of Operation Dixie.

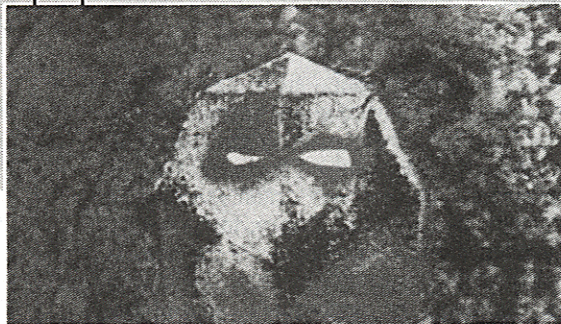

# THE KLINGON PEOPLE

## KLINGON PSYCHOLOGY

—Prepared by Klingon Bureau, Star Fleet Command, for the *Klingon Intelligence Briefing*, Stardate 2/2306.12

To outsiders, Klingon society remains largely a mystery, because many find incomprehensible a way of life that expresses itself as the continuous quest for power and conquest. Viewed psychologically, however, the historic Klingon mission of expansion results directly from several distinct motivations in the Klingon psyche. These elements are conflict, survival, success, and unity.

### CONFLICT

At the heart of the Klingon way of life lies the fundamental concept of perpetual conflict. Klingons conceive of conflict in different ways, often simultaneously. The notion can apply to threats to personal safety, challenges to the safety of an extended group, racial conflict, competition for position within the social order, and even within one's own family line.

To a Klingon, conflict is a positive mode for expressing the desire for recognition and advancement and the individual's right to exist and prosper. Conflict not only identifies friend and foe, but also advances the fittest for the good of the social order. Finally, Klingons enjoy struggle for its own sake.

The idea of conflict has also created the *komerex zha*, or perpetual game, in which all Klingons participate from birth to grave. Based on the principle of eternal conflict, warriors advance themselves at the expense of weaker rivals. The game applies as much to rival powers as it does to Klingon individuals.

### SURVIVAL

Allied with the notion of conflict as a positive experience is the basic need for survival. In a Klingon context, survival does not mean mere personal safety, however. When speaking of survival, a Klingon includes the safety of his family line. Whether an action is taken by an outsider or by a family member, it can deeply affect not only the individual, but his entire line as well. Such actions translate into gains or losses of political clout in relation to other families. Clearly, the Klingon's extended survival instinct includes responsibility for countless individuals.

### SUCCESS

Common beliefs notwithstanding, the typical Klingon does not fight and die simply for the sheer sport of it. The Klingon tempers desire for conflict with pragmatism. He does not seek or kill for the same values and objectives as Humans. Before deciding on a course of action, the Klingon considers three factors: loyalty to the Empire, to his family, and to himself. Success, in the Klingon sense of the term, is anything that promotes an advantage in each one of the three categories. Although an individual's spur-of-the-moment decisions may seem to his personal benefit, considerations of family and state are never far removed.

When a Klingon has done his duty to the Empire and to his own family line, he will then look exclusively to his own future. An ambitious Klingon earnestly desires to establish his own family line, not so much for wealth and influence but as a means of controlling his own destiny.

Curiously enough, there is a fatalism in Klingons, reflecting a belief that each individual is allotted a finite portion of luck to be used or forever lost. If a Klingon believes that 'his time has come', he is likely to seize the moment, no matter what the consequences.

### UNITY

Unity is the fourth major element of Klingon psychology. All Klingons belong to something or someone: either to the Empire, their Emperor, their family line, their individual civilian or military commanders, or their own sense of duty. This sense of belonging is evident at every level of Klingon society. Some scientists believe that the earliest Klingon *kuve* were landless workers who, over a period of time, became enslaved through a lack of mutual support. The Klingon phrase, "The weak enslave themselves", probably originates with this notion of Klingon-turned-*kuve*. (Others hold that the first *kuve* were rebellious linemembers who unsuccessfully rebelled against the dictates of their *epetai*.)

## "The weak enslave themselves."

Although most Klingons belong to a specific group or organization, they are also property of the state, to be used or discarded according to the Empire's needs. In return, the typical Klingon can call upon a vast array of Empire-wide resources when pursuing a goal that would also benefit the *komerex*.

The Klingon's notion of unity includes the fear of disunity, that is, the shame and disgrace of abandonment. As long as he commands respect, a Klingon receives unquestioning obedience from subordinates. Should he lose their respect through personal failure, a leader also runs the risk of losing his command and even his life.

Although the concept of unity produces a degree of discipline and regimentation seldom seen in other cultures, it also produces the Klingons' greatest flaw. A Klingon never feels completely autonomous. There are the ever-watchful eyes of fellow linemembers, subordinates, and superiors, as well as other Klingon individuals eager to advance their own aims at the expense of another. This produces an atmosphere of fear and paranoia. Daily routine is monitored, conversations are recorded, and every Klingon action is subject to critical analysis, all in the name of maintaining the unity of one's ship, one's command, one's line, or the safety of the *komerex*.

To outsiders, Klingons seem cold-blooded, capable of committing acts of senseless cruelty without remorse. Star Fleet officers should avoid judging Klingon morality, however, and concentrate instead on what any Klingon is likely to do in an encounter. It is very dangerous to expect Klingons to behave according to our ethical or moral beliefs. In fact, interrogations of numerous Klingons have revealed that they consider only one thing to be immoral and therefore avoided: becoming vulnerable to others.

## THE KLINGON MIND

[EDITOR'S NOTE: Following is an excerpt from the introduction to *The Klingon Mind*, by Dr. Wil Hanselm of the Star Fleet Psychological Warfare Division. Though the study was published just after the Four Years War, it is still considered one of the most insightful examinations of Klingon psychology.]

In recalling the horrors of the war just past, many people see the Klingons as nonindividual beings who think and act as a unit. This view, however, dooms us to underestimate the subtleties of the Klingon mind. They are alien, and so we cannot judge them by Human standards of behavior. Even so, Klingons exhibit a range of personality types as wide as that of Terran Humans. It is just that the range has different parameters than our own.

As a race, Klingons are indeed hard, unforgiving, even cruel. Within the group, however, individuals vary in their expression of these traits. The gentlest of Klingons might seem harsh to a Human, and the most open and naive of their race would likely seem secretive and suspicious. Within their own culture, though, the differences are recognizable and broad. There is no 'average' Klingon any more than there is an 'average' Human.

During the Four Years War, Star Fleet devoted intensive efforts to developing psychological warfare programs designed to intimidate the enemy. Then we realized that the intimidation so much a part of Klingon daily life is far more intense than any of us could devise. The Klingons understand intimidation on an internal level that Humans never experience, and so it is a useless weapon against them.

On the other hand, Klingons as a group do not understand the concept of cooperation as Humans do, because it is not a part of their survival behavior. Klingons cooperate only when forced, while Humans cooperate almost by instinct, because millions of years of successful evolution

have reinforced the behavior. Humanity thrives on diversity. The Klingons, however, deny diversity as a virtue. In the end, it is this ability of Humans and other Federation races (most notably the Vulcans) to accommodate the goals of others that has brought greatest success in psychological warfare.

The Klingons believe that their greater strength gives them the right to subjugate other races, even that this right binds servant and master together. Federation efforts to subvert Klingon servitor races proved so effective just because the Klingons never considered the possibility that beings who had surrendered their freedom would ever again rise in resistance. Though the UFP created no major upsets of Klingon rule purely through subversion, when servant races were encouraged to form underground resistance movements, the resulting chaos often crippled Klingon supply efforts in the war zone.

An understanding of the difference between the Klingon and Human psychological ranges also proved useful in developing combat strategies. For example, 'cautious' Klingons do exist, but what a Klingon considers cautious would look rash to a 'careful' Human. That is why Klingon commanders can be goaded into making bold moves that turn out to be foolish blunders once they learn the true strength of their foe. Remember, though, that Klingons do not believe it is vain to seek glory, for in the Klingon culture, one *must* perform 'virtuous' deeds publicly or the effort is usually wasted.

Most Humans believe that good and evil are absolute terms, with all other behavior on a spectrum somewhere between them. Being eminently pragmatic, Klingons do not believe in these absolutes. What advances the individual (or the Empire, which improves the individual's status, too) is good. What diminishes the individual is evil. This does not deny the Klingons' capacity to sacrifice for the ideals they revere. Admiral Komex, for example, betrayed his Empire's secrets not because he thought war with the Federation was wrong, but because he believed the conflict was harming the Empire, his troops, and, by extension, himself. He cared less for what would happen to him after the war than for the loss of status he and all Klingons would suffer if the Empire was decimated by continuing the war.

The Klingons are conquerors by nature, which makes them view conquest as a virtue in itself. The subtler minds among them recognize that there are different forms of conquest. One Klingon might only be satisfied when he had slain an enemy, burned his lands, slaughtered his line, and pillaged his belongings. Another might find it more satisfying to leave an enemy's life, lands, line, and belongings alone, and to disgrace his honor instead. Still another might plot to use his enemy to gain higher status, but always seeing to it that his rival knew that he had been used as a steppingstone. All three approaches are typically Klingon, though they are as different as any three Human reactions to a stress situation. Under stress, Humans seek to escape. Klingons in stress situations seek to dominate. This fundamental difference in psychology is at the core of successfully predicting Klingon reactions, which is the heart of psychological warfare.



## STAGES OF KLINGON LIFE

Because of their shorter lifespan, Klingons mature very rapidly. Their shorter lifespan has also created a race that does not believe in wasting time in pursuits that do not immediately relate to survival and advancement of the individual (and through the individual, the race as a whole).

### EARLY FAMILY LIFE

[EDITOR'S NOTE: This material on early Klingon life draws heavily on the report included in Star Fleet Command's *Klingon Intelligence Briefing*, available from FASA.]

In the Klingon Empire, either strict custom or the higher-ranking members of the male's line control the family unit. Thus, individual family members have little or no say about the size, composition, and responsibilities of their group.

The Klingon family unit results from a prolonged period of consortship. It is not so much a marriage in the Human sense of the word as it is a contractual arrangement for mutual protection. When the female partner of a consortship decides to have children, the couple applies to the family administrator, usually a person of *vestai* rank or above.

If the application is approved and a child is born, he becomes an immediate ward of the state until the age of three. At any time during this period, and for any reason, the parents may disown the child. If the unwanted, lineless children are physically sound, they enter state orphanages resembling military training camps, which will care for them until the age of twelve. At that time, such children may apply for admission to the Imperial Star Academy for officer training, if qualified. Optionally, they may pursue a civilian career.

If the parents do formally recognize the infant as a member of their family line, the child remains under the exclusive care of the mother until age twelve. That choice usually depends on whether the mother has her own military or political career, however. If she wishes to forgo rearing her child personally, she would leave such duties to trusted members of the house line. The male takes little direct part in these matters.

There is little evidence suggesting genuine affection between Klingon parents and their offspring. There is also no recorded evidence of Klingon children having pets, although many adults later acquire them as status symbols. This lack of emotional attachment, so foreign to Humans, characterizes the formative years of a Klingon's life. The individual learns early not to anticipate more from life than he can seize for himself.

Literate *kuve* handle the Klingon child's formal education. Should the child's basic competencies later be judged inadequate, the *kuve* instructor usually pays with his life. In the rare event of several children in a family, the first-born child remains in the parent's household. Family line members or their servitors care for all other offspring. By age three, the Klingon child begins training in the basics of a Klingon education, including reading, writing, mathematics, and combat skills. Even the youngest Klingon takes part in martial games. By age five, he has progressed to weapons that can cause injury, and by age seven, to potentially lethal combats. This training will usually prepare the child for his family's preferred branch of service, whether it be Navy, Marines, or Administrative.

Formal contact with other children does not typically begin until the age of seven or eight, at which time the child must begin learning to compete successfully against his peers. That means he must take a series of rigid examinations that test his suitability for continued education. Officials from within the child's own line used to oversee these evaluations. Recent evidence suggests that Imperial Security is now gaining control of these crucial exams.

If the child proves suitable for continued formal education, he can enter the Imperial Star Academy. The Academy offers four years of grueling training in exchange for a military career as an officer in either the Imperial Navy or Marines. The child may likewise train to enter civilian life as an administrator or bureaucrat, although this is rare. More often, the state will consider such children expendable commodities to be used for various civilian tasks, such as involuntary colonization of new worlds, and so on.



### ADULT LIFE

The difference between Klingon civilian and military personnel is very small. In the Empire, everything is oriented to the military, with *civilian* referring merely to those serving in non-combat work or who are retired from active service.

At age ten, the child is 'dedicated' to one branch of service, based on his family's wishes and his performance in early training. (The line family's wishes do not always coincide with that of the Empire, however.) Some lines will allow children who fail to show aptitude for the line's favored branch to be dedicated to another branch, yet to remain with the line. Some require that such children be given for adoption to an allied line within that service or to a House of the Lineless. Some even run such strenuous training programs that children either complete the training to the instructors' satisfaction or die in the attempt.

At dedication, a child takes a new first initial, which corresponds to his branch of service. (In closest translation of the *Klingonaase* sound equivalents, these are *K* for Navy, *M* for Marines, and *A* for Administrative services.) The next two years are spent in intense preparation for enlistment. From age ten to twelve, the Klingon is considered an 'adult' in terms of responsibility for his own actions, but he is not yet given the freedoms enjoyed (if that is the word) by Klingons who have entered the service. At age twelve, the child is inducted into the service chosen for him. Specialized training then begins, lasting from only a few months for common laborers up to four to five years for Naval officers and complex professions (doctors, diplomats, and others).

Those showing particular promise may enter the various service academies. Others become soldiers, laborers, and support personnel. The soldiers, at least, have some status. Laborers, tradesmen, and other low-placed administrative types are second-class citizens. They can hope to improve their status somewhat if they are industrious and useful to the Empire, but their real dreams are often to produce children who will be better suited to the military than were their parents.

**"When a show of teeth is not enough,  
then bite—but bite deep."**

—Klingon proverb

There is no minimum term of service in the Klingon military. Once in, it is for life. When the career of a Naval or Marine officer or administrative leader reaches a point where he has enough influence to serve the Empire without being on active duty, he may retire from active service. There is no fixed time schedule for retirement, but most officers realize that they must clear the way for younger, ambitious Klingons. By age 40 (a bit older for Fusion-race Klingons), a Klingon is considered too old to be a viable asset to the Empire in an active-duty position. Even a "retired" officer may return to active duty, of course, if he is fit and his superiors decide to call on him.

Lower-ranking individuals rarely retire. If they do not get ahead in their service, they will probably be killed in combat, or serve until they are too old to continue. Military personnel of every rank receive medical care, but eventually the Klingon cardiovascular system gives out. Unusual cases like Keth the Centenarian (the Klingon Emperor who lived to be more than 100 Terran years old) notwithstanding, few Imperial Race Klingons live more than 60 years, even with the best of care. Human Fusions live slightly longer, with Romulan Fusions adding perhaps a decade and a half to their lifespans.

Very few Klingons die of old age, however, especially in the military. Death in battle (or at least in hazardous service) is more common, and most Klingons consider it more honorable. It is common for aging Klingons to request more hazardous duty, hoping to gain either quick glory and reward or an honorable end before their physical faculties fail them. Such requests are nearly always granted. An honorable death is the privilege of every Klingon—the only privilege that the Empire grants with no strings attached.

## KLINGON SOCIAL STRUCTURE

As stated previously, Klingon society is based on a single warrior class. Every Klingon, regardless of gender or social position, is first and foremost a warrior. He might be a trained scientist, physician, or diplomat, but when it comes to engaging the enemy, he fights with a singleminded ferocity rarely seen among Federation races.

Because Klingons live under conditions of surveillance, intimidation, and paranoia, it might seem impossible for them to form social groups. There are, however, two institutions that offer the individual Klingon some friendship and, more rarely, intimacy. These are the linefamily and the institution of consortsip, which together form the bedrock of the Klingon state.

## THE ESTABLISHED ORDER

—Reprinted from *Klingon Intelligence Briefing*, prepared by the Klingon Bureau, Star Fleet Intelligence Command.

Contrary to accepted belief, Klingon society allows for a surprising degree of social mobility. The individual Klingon can rise as high as he wishes in his profession, but it will help if he is also very intelligent, well-connected, and has accumulated some influence. The reverse, however, is also true. No matter how exalted his position, if an individual shows himself unable to function well in his job, he will probably be eliminated, often permanently.

The Klingon state is a system continually in flux, an instability that leaves the average Klingon in a state of continual fear, or at least continual awareness of his vulnerability to changing circumstances beyond his control. Due to this, the average Klingon would feel inhibited about taking risks that might result in others questioning his competency.

The Klingon social order is, if nothing else, efficient and practical. Witness the Klingon/Human and Klingon/Romulan Fusions that have begun to appear in great numbers. Klingon practicality suggests that the best way to defeat an enemy is to know him, and the best way to know him is to become like him. Klingon Fusions were seen as the best means for dealing with the Human-oriented Federation and the Imperial Empire's most dangerous opponents, the Romulan Star Empire. No one knows exactly when the first Klingon Fusions were introduced, but even the Fusions consider themselves biological hybrids and artificial creations.

Various sources indicate that Fusions, though often as highly trained and motivated as their Imperial brethren, are second-class citizens. Choice assignments and superior ships go first to Imperial officers, then to Human Fusions, and lastly to Romulan Fusions, against whom racial prejudice is especially strong. Such bigotry may indicate how threatened Imperial Klingon house lines feel at the growing power of certain Fusion lines.

There seems to be no gender prejudice against females in important positions, however. Klingon females of all racial types serve with equal distinction in a wide range of expertise. The one exception applies to females attempting to obtain command posts in military operations. One theory postulates that there were once an equal number of female and male soldiers, but that the sexes disagreed about how to maintain the social order. This may have led to an open military struggle for political and military supremacy, which the female warriors ultimately lost.

Although there is no proof for this theory, it is true that Klingon males hold almost all positions of command rank, either aboard ship or on ground installations. The average male is more at ease with a Fusion male in a position of authority than with a female, even if she is an Imperial. Tantalizing rumors of rare exceptions to this rule have surfaced, although Star Fleet Intelligence can neither confirm nor deny whether females of particularly high intelligence, superior skills, and social connections have achieved positions of high military authority.

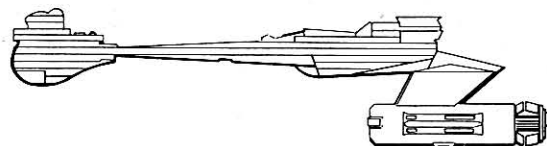

## FAMILY LINES

To Klingons, the term 'family' includes much more than the offspring of a group of individuals. Each line also carries an economic status, political affiliation, military and civilian obligations to the Empire, and claims against the Empire. A typical Klingon family line often includes hundreds, even thousands, of individuals, many of whom have no direct biological connection to the house leader, or *epetai*. At present, Star Fleet Intelligence has no clear idea just how many Klingon family lines currently exist. Best estimates give as few as 89 and as many as several hundred formally recognized family lines. Twice as many unofficial lines (those lines lacking recognition by the Empire) may also exist.

Evidence suggests that all Klingon lines are one of two types: extended lines or closed lines. Extended family lines are social/political groups in which Klingons of different racial backgrounds interact freely with one another for the benefit of all concerned. In these lines, Fusions and Imperial Klingons coexist in relative harmony. Closed lines are composed of only one racial type, and include a variety of ranks and social stations. The extended line probably allows greater flexibility, and, thus, greater political influence. In the closed arrangement, members have banded together for mutual defense against racial prejudice or to preserve the racial 'purity' of the line's founders.

Though an individual can join a family line through either birth or adoption, changing lines is a serious business. Former linemembers may consider the matter a personal betrayal, to be revenged only by the betrayer's death. An individual can rise in his line primarily by performing acts of heroism or special deeds in the service of the *komerex*. By doing so, he proves himself worthy of greater social status, which his immediate superior bestows in the form of the title of *tai*. Similar actions may elevate him further in the line, subject to the approval of the line *epetai* or a senior house member with the rank of *zantai*. (This system also prevents individuals from gaining too much influence too quickly.)

A linefamily offers its members status and various kinds of protection, as well as a safe haven for Klingons who live long enough to reach retirement. In return, a linemember is obligated to support the house financially and politically.

The *epetai* is more than just the patriarch of an extended family group. He combines the power and responsibilities of a financial comptroller, political spokesman, corporate magnate, legislative coordinator, and ultimate judicial authority for every linemember. In times of a weak Emperor, house law laid down by an *epetai* may even take precedence over Imperial law. Indeed, linemembers often deliver malefactors to their linebrothers instead of to the authorities.

## LINENAMES

Klingons have a given name and, usually, a linename. A child's given name can begin with any letter. At maturity (ten years), the first initial changes, depending on the career path chosen. Navy names begin with *K*, Marine with *M*, and the civilian services (academic and bureaucratic) with *A*.

Klingon names are often shortened or ablated, and nicknames are at least as common as among Humans. There is apparently sex differentiation, but what sounds feminine or masculine in *Klingonaese* is not often apparent to Human ears, and so no hard rule can be established.

The linename bears a prefix indicating personal status. In ascending order these are:

No prefix

*tai*

*vestai*

*sutai*

*zantai*

*epetai*

Any serving ship's officer would be *tai*, or perhaps *vestai* if highly placed. A ship's captain would be *sutai*, possibly *zantai* if he had done something very famous or significant. An admiral would be *zantai*, certainly. *Epetai* is very rare, and would never apply (except as mockery) to anyone under the age of 50. The full name is thus written as Kang *zantai*-Dvistrill or as Koanth *tai*-Lassenti, who may have been known, respectively, as Vang Dvistrill and Loanth Lassenti in childhood.

Lineless children have the number of their House (orphanage) as a surname until maturity. After that they have no surname.

The Klingon lines are more than just families, less than the great dynasties of Earth's history. Perhaps they are best described as networks of mutual obligation and support. It is not easy to survive in Klingon society, and so loners stand even less chance.

Though lines do occasionally feud, it is not common, because a war between lines usually weakens both to the point of destruction. Lines tend to act to secure positive advantages for their members, within the shifty and unpredictable limits set by Klingon society as a whole.

As lines expand through births and occasional adoptions, there comes a point when the line is so large that one's obligations bring a diminished return—especially if one's parent had many offspring with more-or-less equal claim on his favors. At such a time, one or more members will become line-founders, changing their linenames and striking out on their own. Many line-founders fail, because their first act is usually something foolishly bold to establish the name in the Empire's eye. Nonetheless, the potential founder is respected, including by the line he leaves.

—From *An Informal Guide to the Klingon Empire*

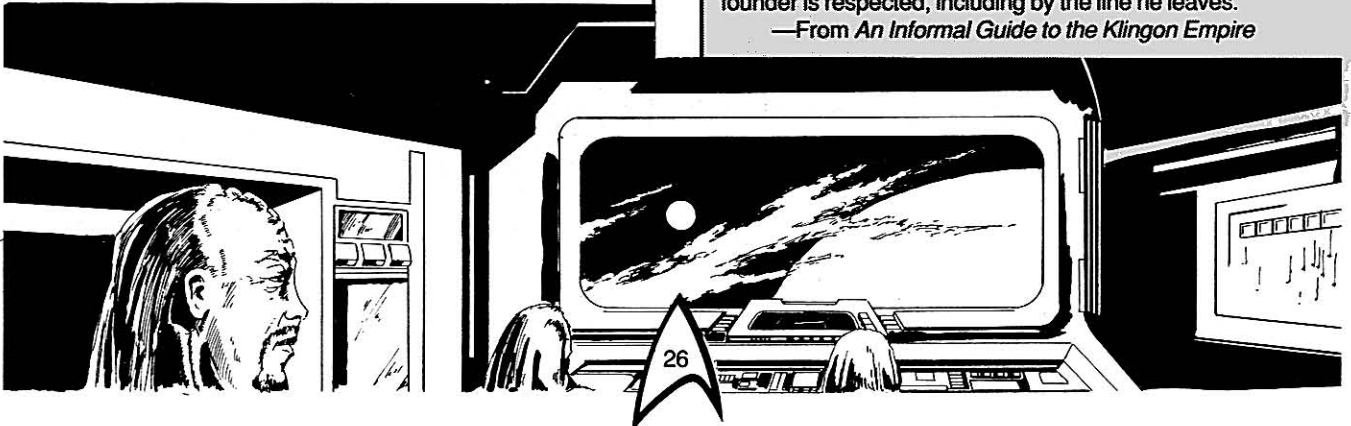



## STATUS AND NAMES

—Prepared by Commodore Willis Valarian, Klingon Bureau, Star Fleet Intelligence Command

In terms of social mobility and influence within the bureaucracy, a lineless individual in the Klingon Empire is at an enormous handicap. Starting a new line is an uphill battle, and the Empire will take no notice until the new line or its founder distinguishes the line by some act of value to the Empire.

Most line obligations go up-rank, not down. (That is, a linemember has more line obligations to those of greater status than they have to him.) Therefore, even a linebrother would not presume upon line affiliation too much. Nor would one betray a linebrother, unless doing so would bring enough power to stave off retaliation by other family members. Generally, the safest way of improving one's status within the line is to outlive those with more status.

An individual Klingon may earn a more exalted name-prefix at any time. These are not awarded formally, and there are no hard-and-fast rules for when the change occurs. The advancement comes when enough individuals of status begin to address or refer to the individual by his new

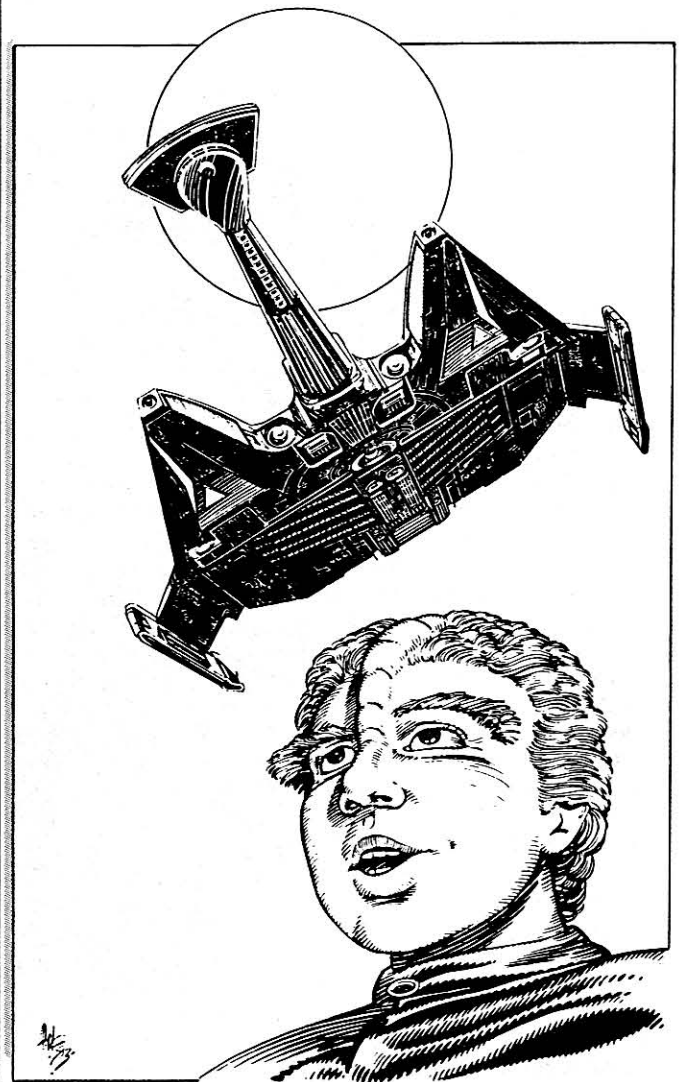

name prefix. Thus, he becomes *zantai* instead of *sutai* when enough people of higher status refer to him that way. Generally, such improved status is the result of a general history of accomplishment, rather than one or two especially noteworthy actions. There are exceptions, however. When a seated Emperor calls someone *epetai*, that Klingon can safely start to use that prefix in the Empire.

The status reflected by the name-prefix is very seldom lost, and so cases of someone reverting to a less-prestigious prefix are extremely rare. One known case is Kevar *zantai-Lobaeth*, a former Naval officer who voluntarily began to use no prefix at all after losing a major battle in the Four Years War. He refused to respond to the use of a name prefix until his honor was restored. Later in the war, he died serving as a lowly Assistant Helmsman in a major battle, and so his status was restored posthumously. On the other hand, Admiral Komex, who was apparently executed in disgrace after the Four Years War, never lost his personal status. To revoke status after it is earned is an insult to those who accorded the honor in the first place, implying that they must have made a mistake. Most Klingons would not find this situation acceptable.

## CONSORTSHIP

[EDITOR'S NOTE: The following was compiled from reports gathered by historian Irenna Suparov, who served as Assistant Chief Negotiator in the Federation Diplomatic Delegation to Sheridan's World, Stardate 2/2104.]

Despite social conditions that leave little room for positive emotional experiences, a Klingon is fully capable of experiencing personal devotion, self-sacrifice, and a sincere caring for his mate. Klingons do not have husbands or wives in the Human sense, however. They use these terms only for the purpose of communication when dealing with another race. What they do have is an arrangement known as consortship, which can be formed by either gender at any time. Klingon consortship is something more than a betrothal and less than a marriage, and has deliberate business overtones.

Having determined that an individual is suitable for consortship, the suitor (usually the male) applies to the head of his intended's linefamily. The line *epetai* must carefully consider the political ramifications in any prospective consortship, especially when the suitor comes from another family line. If the suitor does obtain the *epetai's* approval, he can now approach his intended and present the matter in a formal, businesslike manner. Often, genuine affection between the two may already exist.

Each partner in a consortship can expect certain advantages from the arrangement. The individual initiating the consortship can demand that his intended repudiate connections to former linemembers. Both parties commonly enter into a formal pledge of mutual security, in which each commits to the defense of the other against any and all enemies. In other words, either consort may be called upon to lay his life on the line at a moment's notice, or to fight against former friends, linemembers, or persons of superior rank. At the start of the consortship, both individuals often ask for and receive immediate benefits, such as promotion within one's department, the promise of reappointment with

one's new mate to a better post, increased wealth, the granting of specific rights within one's new family line, the elimination of a personal rival, or any combination.

There is no mandatory, or even minimal, length of time required for a consortship. At any moment, either consort may renounce his obligations to the other, immediately nullifying the arrangement. However, such instances are no

doubt rare because the injured party would immediately retaliate. Moreover, consortship is based on the mutual trust between the two parties, a rare commodity in the *komerex* and one that few Klingons experience in any other relationship in their lifetime.

These conditions for 'matrimony' may seem mercenary, yet they are perfectly in keeping with Klingon psychology. Consortship of Klingons from different houses may initiate a long-standing conflict between the two houses as the consorts seek to further their own interests while minimizing their own and their offspring's immediate vulnerability.

Klingons appear to place considerable value on this institution. In particular, the typical Klingon male will consider it his duty to be protective, even overprotective, of his mate. Any action that might be interpreted as insulting or hostile to a female consort is likely to bring the male to instantaneous aggression. Failing to react this way would not only make him lose face with his mate, but might encourage others to act insultingly. If the male gives the impression that he is too weak to defend his 'property', he invites danger upon his own head. Thus, whenever confronted by two Klingons who are known to be mutual consorts, Star Fleet Officers are advised to act cautiously.



In Klingon society, there is no stricture against having more than one consort. The only practical limitation is the number of competitors a consort will tolerate before blood is spilled. The possession of more than one officially recognized consort is a measure of personal power and influence among those few willing to accept the risks involved.

—From *Klingon Intelligence Briefing*

## THE KLINGON RACES

—Compiled by Dr. L. N. Po, Xenomedicine Advisor to Star Fleet Intelligence Service.

### IMPERIAL RACE

The Imperial Race, which is the purely Klingon form, dominates Klingon politics, though Fusions have made great strides toward political/social acceptance. There is some hint of bigotry among Imperials toward Fusions, but Klingons consider the gap between the sub-branches to be insignificant compared to the gap between Klingons and non-Klingons. A Fusion is a different form of Klingon, but a Klingon nonetheless. A non-Klingon is someone to be conquered, used, or pushed aside.

All Klingons have a tougher skeletal structure than Humans, with the spinal column particularly well-armored. The Human spine evolved for flexibility and comfort, but the Klingon spine is that of a war machine. Only the Imperial Race, however, shows the trait of a spinal column that curves up and over the cranium, then down the forehead. The Human nerve trunk attaches to the brain at the base (as does the Romulans', Tellarites', Vulcans', and that of most other upright bipeds). The Imperial Klingon nerve attachments are less centralized, with the nerve attachments running all along the central axis of the brain.

The armored spine of the Imperial Klingon produces a ridge down the top of the head that varies in prominence. In some Klingons, the only real evidence of the ridge is a raised skin pattern on the forehead over the extra frontal plate of bone there. The Klingon forehead is, therefore, hard and bony, and very resistant to damage.

Klingons mature earlier and age faster than Humans. A Klingon is full-grown (and considered an adult) at twelve Terran years, and few live to the century-long lifespans enjoyed by many modern Humans. This is partially due to their physiology, which 'burns itself out' faster than that of Humans, and partially due to their martial lifestyle. Few Klingons die in bed.

The average Klingon warrior is stronger and a bit more agile than the normal Human combat soldier, despite the fact that the Human circulatory system is more efficient and the Human spine and joints more flexible. The following excerpt from Ford and Tagore's popular book about the Empire offers an excellent explanation of the phenomenon.



IMPERIAL RACE

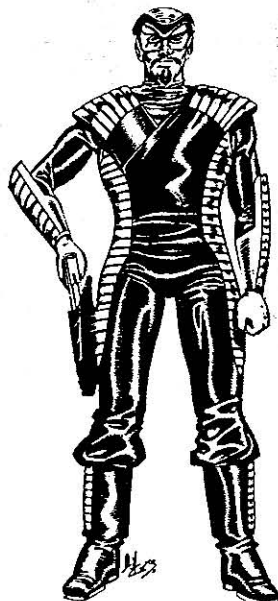

ROMULAN FUSION

29

One of the best-kept secrets of the Empire is that the average Klingon is physically a little inferior to the average Human. This is contrary to popular Human belief, especially among those who have been in a brawl with Imperials. Nevertheless, comparisons of hard medical data show the Imperial Race Klingon to be less well endowed than *homo sapiens terrestris*.

Why hasn't anyone noticed this? The answer is that *absolute* physical ability is not the same as *effective* ability.

The Imperial has been in a sort of psychological battle conditioning since birth—participating in training at school, the Year Games, and urged constantly to excel and triumph. So, Klingons may actually have *less* muscle power, but they do more with what they have.

As a corollary to this, and not to be overlooked, is the fact that Federation cultures—even militaristic ones such as Andor—do not stress fighting to kill, but rather to disable or capture. In shore-leave brawls, for instance, our energetic lads aren't usually trying to hurt anybody. This point is frequently lost on the Klingons.

—From *An Informal Guide to the Klingon Empire* by Ford and Tagore.

Certain aspects of Klingon physiology work as much against the Klingon soldier as for him. Because Klingons have more surface blood vessels than Humans, they suffer more from cuts and punctures that may cause blood loss. This vulnerability is most pronounced in Imperial Race Klingons. Their nervous systems are better protected against trauma, however, making them more resistant to pain and to nervous shocks such as phaser stun. Even so, they have a greater susceptibility to neural toxins and drugs, especially those introduced through inhalation. (Klingon lungs have greater internal surface area and more membrane permeability than those of Humans or Vulcans.)

Klingons perspire very little. An extensive net of capillaries just under the skin acts as an efficient heat exchanger. The specific heat capacity of thin Klingon blood is also high. Klingons are, as a result, less affected by heat (especially wet heat) and more by cold than most Federation races. (Klingons and Vulcans are comfortable at about the same temperature, but Klingons would find the Vulcan environment unpleasantly dry!)

The long black garments that Klingons wear when visiting Federation installations contain a layer of vapor barrier. A Human wearing such a suit would shortly be swimming in sweat.

—From *An Informal Guide to the Klingon Empire*



HUMAN FUSION

## FUSION RACES

There are several racial subgroups that vary from the physiological type known as the Imperial Race. These are genetically engineered subspecies, that is, fusions of the physical/genetic traits of Klingons and other races. Klingon genetic techniques are far advanced of those practiced in the Federation, largely because the Klingons have no restrictions on the use of live, intelligent experimental subjects.

The Empire originally developed the Klingon/Human Fusion to produce individuals who could more efficiently interact with Human beings, the most numerous racial group in the Federation. Klingon/Human Fusions are more comfortable on Human planets and in Human-constructed installations. In addition, they are more successful in negotiating and interacting with Humans and Humanoid races (and also in practicing Human battle psychology). Klingon/Human Fusions possess more physical endurance than Imperial Race Klingons, mostly due to improvements in the cardiovascular system. The altered skeletal structure and more vulnerable joints make them slightly less inclined to feats of manual dexterity, however.

---

**"It is not enough to destroy your enemies.  
You must understand them as well."**

—Ancient Klingon saying, attributed to the legendary Admiral Korus, the first Klingon flag officer to be executed by his own men.

---

Klingon/Romulan Fusions also exist, though it is not certain whether these came before or after Human Fusions. As might be expected, the UFP has had few dealings with Klingon/Romulan Fusions. Different types of Fusion races rarely serve together. Ship crews and ground forces units are almost always composed of only one sub-race. If the limited Federation experience with Romulan Fusions is any indication, they are even hardier than Human Fusions because of their Vulcanoid cardiovascular system. Their blood chemistry is unique, containing both iron and copper compounds as carriers of oxygen.

Klingon/Vulcan Fusions may exist. Though Vulcan historians are reluctant to divulge much, the Vulcans apparently had some contact with Klingonoid aliens long before the establishment of the Federation. There are no records of encounters with Klingon/Vulcan Fusions confirmed in Federation databanks. If such Fusions exist, they are not numerous. Reports of Vulcanoids attached to Klingon households may actually be cases of mistaken identity with Romulan Fusions. No other genetic fusions with Federation races are known, either because the race is too unlike the Klingons metabolically (*e.g.*, the Andorians or Edoans), or because the race does not wield the political or military power to make the effort worthwhile (*e.g.*, Tellarites or Caitians).

## PSIONIC PROHIBITIONS

Though the Klingons are much advanced in genetic tailoring, they have failed to apply this knowledge to the development of psionic abilities. Despite the fact that both Human Fusion and (especially) Romulan Fusion Klingons are likely to be more psionically gifted than Imperial Race Klingons (based on studies of Klingon engrams), the Klingon Empire seems to categorically reject any development of psychic abilities.

The reasons for this remain unclear, especially when psionic abilities have proven so useful to races such as the Vulcans. It is possible that Imperial Race Klingons fear that research into psionics might lead to the Human and Romulan Fusion races becoming dominant. It is also possible that Klingon research into the operation of the brain and nervous system may not be as advanced as in the UFP. (After all, it is the Vulcans—a Federation member race—who are among the galaxy's greatest experts on psychic abilities and their development. The UFP thus has a distinct advantage in the field.)

Though no one has ever definitively explained the reason, we know that the Klingon Empire maintains an attitude of subtle but definite suppression of psionic research or development of psionic abilities in its own people and in servitor races. If there are Klingon psychics, it is more likely that their government is actively suppressing, rather than encouraging, them.



## GOVERNMENT

It is not really possible for an empire to be an autarchy. All empires have had to make use of territorial governors, satraps, viceroys, counts palatine, puppet kings, General Jaruzselskis, Quislings, and so forth and so on.

The Klingons primarily use Puppet Rulers (local rulers), Imperial Governors (Klingon 'civilian' administrators), and Imperial Military Governors, in that order.

Nobody can afford to oppress (*i.e.*, exert force on) a population to a greater extent than absolutely necessary. A world under an Imperial Military Governor and martial law would probably eventually pass to an Imperial Governor, and then to a local ruler (still answerable to the Empire, of course). For a civilian governor to be supplanted by a Military Governor, however, would imply the grossest incompetence on the ex-governor's part. And we know what happens to Klingons who are branded as incompetent.

(The civilian governor could, of course, call in the Marines to handle an insurrection. But he would do so with great care, because the Marine commander would probably be thinking about how he would have the Governor's office redecorated...)

The Emperor normally has a 'shadow cabinet' of persons enjoying his private trust: advisors, spies, secret agents, and the inevitable secret bodyguards and an assassin or six.

The Emperor is 'advised' (and sometimes controlled) by the Imperial Council, which is made up of the highest military and governmental ranks. It may admit others, and even grant them a vote. Non-Klingons are not eligible, however.

The lower echelons are not answerable to the Council as a whole, but to factions (the Admirals, the Economic Planning Committee, and so on) or individuals within it. (See Organization Chart.)

The Emperor is neither elected (exactly) nor chosen in trial by combat (exactly). It is not possible to become, let alone remain, Emperor without at least the consensus support of the Council. And sometimes single combat has been demanded, when the alternative would have been civil war.

Selection of an Emperor—in fact, of any leader—is based on the *komerex zha*, the perpetual game. Not everyone plays...or do they? To some theorists, it is impossible NOT to play. Yet, denying that one is a player at the game of society is a valid tactic of play, if you follow that.

Anyway, when the Throne becomes vacant, the Perpetual Game shifts into high gear. Personal power structures are tested to the limit, deals are made, debts foreclosed. The 'winner' becomes Emperor. The others adjust their positions, based on how well they played. Some may die, but that is not a necessary outcome.

The Game may be a necessary safety valve for the high-power echelons of a society as internally stressed as the Klingons.

The average Imperial reign is 15 years, and ends with a death by natural causes. (Remember the shorter average lifespan...) The longest was that of Keth the Centenarian, whose longevity is not satisfactorily explained. The shortest was one hour: General Kagga, who was granted the accession while under sentence of death, in recognition of his exceptional skill outside the Game. He was executed upon taking the throne.

—From *An Informal Guide to the Klingon Empire*



## KLINGON POLITICS

—Reprinted from the *Klingon Intelligence Briefing*, prepared by the Klingon Bureau, Star Fleet Intelligence Command.

The most pressing issue in either internal and external Klingon affairs is the question of reconciliation with the Federation. In this debate, the Subaiesh family is the recognized leader of the peace movement within the *komerex*. The Subaiesh maintain that the Organians will never permit a renewal of armed conflict, for whatever reason. They contend that it is unreasonable to prepare for a war that, in all likelihood, will never occur. Men and materiel on station along the Organian Neutral Zone could be employed with crushing effectiveness against the traditional Klingon enemy, the Romulans.

The opposition centers around the powerful Reshtarc line, who counter that not only have the Organians apparently ceased to enforce the treaty, but there are a number of Klingon/Romulan accords already in effect. Although Klingons will break treaties when it is convenient to do so, the Reshtarc believe it is more important to eliminate the Federation, by whatever means possible. Otherwise, the UFP will continue to grow militarily and economically until it becomes impossible to destroy them.

At this time, the militarists are gaining the upper hand, particularly since the Klingon discovery of the Genesis Device, which they refer to as the Genesis Torpedo.

### "Justice belongs to the strong."

—From a Klingon battle chant

Another important issue is that of Orion neutrality, which the Klingons have long supported because both races prey frequently on Federation spoils. While there is no direct evidence linking the large corporate houses of the Rigellian worlds with the Klingons, there is little doubt that both sides have been helping each other covertly for years.

All this may, however, be coming to an end. For the first time in many years, sentiment is swinging against continued affiliation with the Orion merchant guilds. The Drexia, a Klingon/Human Fusion line, seems to be leading this movement. It is not clear whether the Drexia advocate complete separation from the Orions or if they are simply alarmed by a growing Orion presence on planets within the Klingon sphere of influence. The Klingon Empire is also apparently displeased about increased Orion activities within the Triangle Zone, despite the fact that Klingons and Orions have occasionally acted together in defiance of Federation interests.

The third important issue concerns the Imperial Klingon States, which have recently gained influence among the independent worlds in the Triangle Zone. The Klingon Empire previously denied the existence of these renegades. Later, the Empire denounced them as traitors suitable only for target practice, fair game for any commander wanting to make a name for himself. Recently, however, the existence of these dissident Klingons has become more than just an embarrassment to the *komerex*. The renegades' power base has grown at the expense of their parent empire, and, in particular, at the expense of the current Emperor. The IKS has successfully blunted Klingon expansion within the Triangle. IKS agents are presently waging a propaganda campaign aimed at discrediting the harsh totalitarian rule of the present regime in favor of the presumably more flexible and democratic alliance of family members in the IKS.

Tales of freedom of action, rapid promotion, and lucrative plunder have motivated many talented officers to join the IKS. By setting themselves up as a rival *komerex*, the IKS is inviting the Empire to retaliate. So far, the Empire has taken no direct military action, probably because they do not want to give the UFP an excuse to enter the Triangle in force under the guise of 'peace-keepers'. Intelligence sources suggest that several houses are considering forming special hunter-killer squadrons with the sole mission of destroying IKS men and material. Among these house lines, the Juriss have apparently committed themselves wholeheartedly to the idea. They are reported ready to pledge their entire line holdings to eliminate the traitors as soon as the Emperor grants permission.

The fact that these actions originate from lines dominated by Klingon/Human Fusions may indicate the considerable power of these houses. Despite their increasing dominance, the Imperial Klingons may be forced to form an alliance with the Klingon/Human Fusion lines. If this does happen, the Fusion lines will no doubt extract a high price for their assistance.

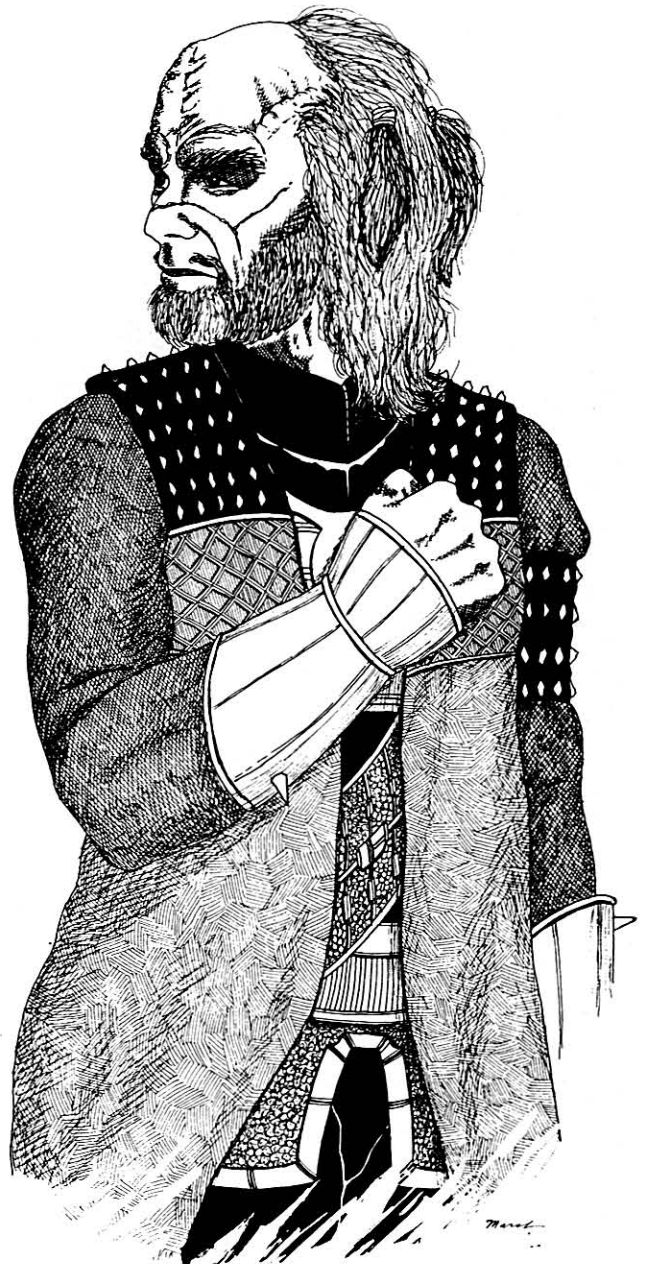

## CIVILIAN RANKS AND TITLES

The Klingon philosophy of a title for everyone extends into civilian life, as explained in the following excerpt from *An Informal Guide to the Klingon Empire*. For more detailed information, see also the *Klingon Intelligence Briefing*, available from Star Fleet Intelligence Command or FASA.

While civilian titles such as Doctor, Senator, and President are in use in the Federation, the Empire is much more rank-conscious, and EVERYONE has a title. Not to introduce a Klingon by his title at any occasion even remotely formal—and most informal ones—is a considerable insult.

Where a specific title such as "Procurements Manager" or "Traffic Coordinator" is not applicable, the generic "Administrator" may be used for a member of the bureaucracy.

In the sciences, "Specialist" is the lowest generic title. An "Accredited Specialist" has some technical credit such as a major publication or the equivalent of a basic patent worthy of note; some Klingons are more concerned than others about whether or not their accreditation is mentioned on all occasions.

The highest technical rank is "Thought Master". There is no direct Federation equivalent, but a Klingon Thought Master should be treated as a tenured full professor with multiple doctorates, an authority in his or her field.

## RELIGION

The renowned Vulcan sociologist Satak said that to understand a culture, one must see the difference between what its religion says and what its people actually believe. In the case of the Klingons, this is not as difficult as with some other cultures.

The Klingon people have never had a formal religion, not even in their earliest prehistory. They do not seem ever to have seriously speculated on the existence of beings more powerful than themselves. Early Klingon legends do mention "demons", though the ancient *Klingonaase* word translates more properly as "those who destroy from the darkness". This shows that even the primitive Klingons did not think of these beings as 'supernatural' horrors, but merely as powerful and unknown dangers.

One early Klingon concept that seems to refer to a higher power is the belief that actions occurring beneath the Naked Stars have a special significance, as if they were being recorded somewhere. What we know of the cloudy and usually starless skies of Klinzhai (as reported by Klingon literature and the handful of non-Klingons who have been there and lived to tell of it) may explain why early Klingons took special note of any actions on a night when the stars were visible.

This belief may relate more to the current Klingon myth of the Black Fleet, which is where worthy fighters go when they die. These two legends of the Naked Stars and the Black Fleet do not so much promise a reward for worthy deeds in this world, but offer the possibility for redress of grievances in the next. Such beliefs are common among primitive peoples, and are usually born of a need to understand why that which is 'good' does not always triumph in life.

The Klingon concepts of the Naked Stars taking note of worthy action, and the Black Fleet as a form of afterlife do not exclude non-Klingons, however. According to even the earliest known Klingon legends, the stars remember any worthy deed by *any* individual; adversaries who were worthy opponents from any group may return again in the Black Fleet. One early Klingon epic poem repeatedly pits a great Klingon warrior/hero against a half-demon adversary. When the hero finally slays his ancient enemy, he expresses the belief that they will again meet after death, when perhaps the enemy will kill *him* several times.

Nowhere is the Naked Stars explained more clearly than in this following passage from Tagore and Ford's popular book about the Klingon Empire.

It is important to understand that this is not a simple primitive belief. The Klingon does not necessarily believe that the stars literally watch and record his actions. Did the ancient Greeks of Earth believe that Zeus literally appeared as a white bull to carry off Europa? But such legends exist, and survive, because they are in some way useful. In the case of the Naked Stars, the need seems to be for a higher, absolute justice that Klingon society does not provide. ("Justice belongs to the strong" is a common Klingon proverb.) A fragment of a Klingon ballad-poem may make this clear:

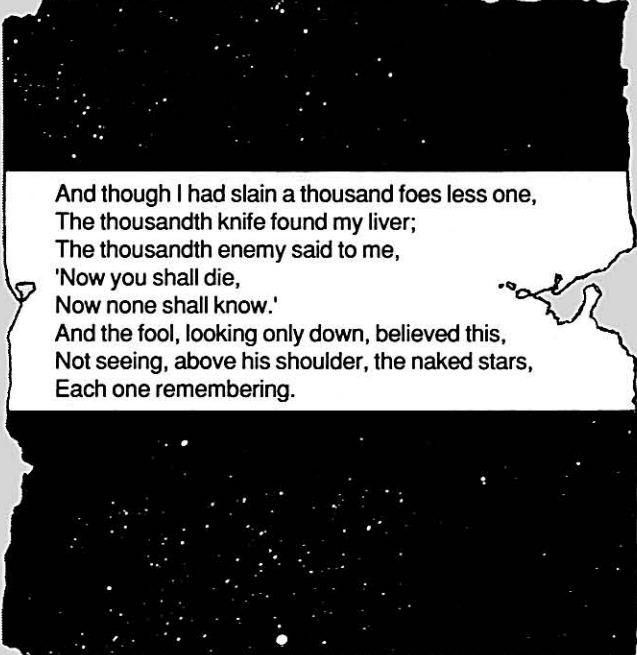

And though I had slain a thousand foes less one,  
The thousandth knife found my liver;  
The thousandth enemy said to me,  
'Now you shall die,  
Now none shall know.'  
And the fool, looking only down, believed this,  
Not seeing, above his shoulder, the naked stars,  
Each one remembering.

There is no Klingon idea of a god. The names of past Emperors or heroes, or of powerful animals such as the "stormwalker" are invoked, but this is no more religious than the Human exclamation "My God!" The Empire has encountered many religions, however, and is well aware of the strength that religious faith can have. They do not wholly discount the idea of supernatural beings. In fact, they cannot. Beings such as the Organians and the Metrons demonstrate powers that are godlike, if not actually divine. But to put one's trust in another is not a Klingon trait. It is difficult to imagine a Klingon worshipping any entity that could be swayed by prayers.

—From *An Informal History of the Klingon Empire*

# THE KLINGON ARMED FORCES

—Prepared by Admiral Karl Zalman, Star Fleet Command.

## IMPERIAL FLEET

### ORGANIZATION

Though the United Federation of Planets has been fighting the Klingon Empire for years, not much hard data is available on the organization of its forces. Based on battle encounters with the Klingons, it appears that the Navy is the core of the armed forces, with all other services taking a back seat. The Empire seems to lack an exploration branch operational along UFP borders, as any scouts detected have usually been active Naval units. Units involved in what the UFP would normally consider an exploration function appear to be Naval raiders, taking what they want now, and not worrying about the results of their actions.

Otherwise, the Klingons seem to be organized along lines similar to the Romulan forces. It appears that each quadrant of Klingon space has its own internal support services such as supply units, medical, and so on. This decentralization would tend to create squabbling between quadrants for the best equipment and personnel, and would also weaken an attempt at a major offensive.

### RANKS

Klingon rank structure seems to resemble that of the Federation Naval forces (with a few exceptions noted in the following excerpt from *An Informal Guide to the Klingon Empire*). Star Fleet Intelligence has been able to identify the insignia used by most command personnel through analysis of visual data received during contacts over the years. It does appear that the Empire has its own equivalent of the Federation Star Fleet Academy. The Federation has no confirmed accounts of the equivalent of a Federation cadet serving on Klingon vessels encountered. Younger officers do serve aboard Klingon ships, but they also seem to have direct authority. It is believed that the Empire simply promotes younger personnel who have demonstrated officer capabilities.

The Klingon's military rank system is similar to the Federation's, and so direct translation (Captain, Petty Officer, and so on) will serve in most cases. The following are a few exceptions.















*Squadron Leader* is a position, not a rank, indicating which of the three captains in a squadron is in overall command. It carries more significance on the frontiers, where squadrons are very independent (and are usually referred to by the Leader's name, e.g., Keth's Squadron). A Squadron Leader is still a Captain, and might be addressed as "Captain" without insult, say, by another Leader. Lower ranks would rarely take the chance.

*Admiral* is a generic title for all Naval officers above the rank of ship Captain. If there is a possibility of confusion, the officer may be referred to more specifically as "Admiral of the Fleet", "Training Cadre Admiral", and so on.

A *Thought Admiral* is a Fleet Grand Strategist. Though he has no direct command of ships, a Thought Admiral is above all other Naval officers (at least in theory). It is not an organizationally defined position. There may be no Thought Admiral, and there may be as many as three. Remember that Klingons, while master tacticians, are not strategists by nature and so tend to mistrust anyone who takes the long view—even other Klingons. Thought Admirals are often treated as somewhat useful but dangerously erratic.

From *An Informal Guide to the Klingon Empire*

#### NAVAL (MARINE) RANK INSIGNIA

			
RECRUIT (RECRUIT) (EN 2nd CLASS)	ENLISTED 2nd CLASS (EN 1st CLASS)	ENLISTED 1st CLASS (LANCE CORPORAL)	PETTY OFFICER 2nd CLASS
			
PETTY OFFICER 1st CLASS (SERGEANT)	CHIEF PETTY OFFICER (SERGANT-MAJOR)	CADET	ENSIGN (LT. JG)
			
LT. JG (LT.)	LT. (CAPTAIN)	LT. COMMANDER (MAJOR)	
			
COMMANDER (LT. COL.)	CAPTAIN (COL.)	ADMIRAL (GENERAL)	

(shade is raised brass-on-brass)

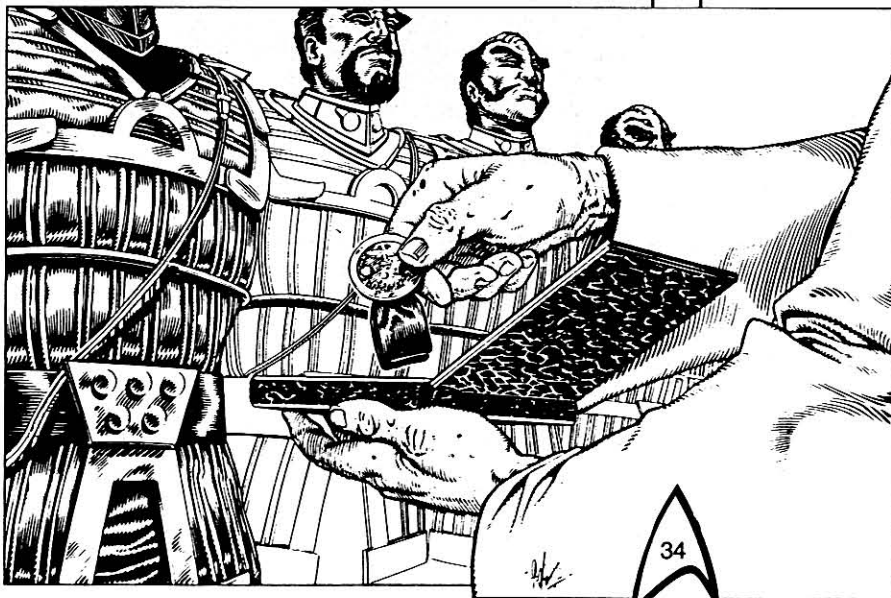

## ACADEMY EDUCATION

The Imperial Klingon Star Academy is the ultimate training ground for young men and women aspiring to become leaders of the Empire. The rigid discipline it imposes is intended to instill the highest possible degree of martial skills and loyalty to the state. The Academy also offers one of the most brutal experiences a member of Klingon society will ever endure. Not only is it a place of learning, but very often a place of torment where the strong make victims of the weak.

While some may question the methods employed, the fact is that the Imperial Klingon Star Academy achieves results. Graduates of the Academy are among the best-disciplined and most highly motivated of all the starfaring races. Having conquered the rigors of the Imperial Klingon Star Academy, each graduate has good reason to believe he is fit to conquer the unknown dangers of space.

Cadets begin their training at the Academy at age twelve. Each trainee enters with the official designation "officer candidate". From the moment of arrival, however, cadets automatically become wards of the state, with all privileges of line honor or connection suspended for the duration of their stay. Any advantages a cadet may have enjoyed previously will not be restored until his graduation or dismissal. During their time at the Academy, each individual is undisputed state property.

### PRIME LEARNING

The first two years of the student's training are spent in Prime Learning. Cadets are organized into Academic Training Battalions (ATBs) under the command of a senior security officer (Thought Master) and various training officers known as Task Masters. Each ATB is further divided into Disciplinary Sections of 20 cadets, with a senior (fourth- or fifth-year) cadet supervising the day-to-day activities of those in his section.

### A Spartan Existence

Cadets begin life at the Academy with very little in their favor. Barracks life is spartan at best. Cadets are housed together, with no distinctions made for gender, racial type, or social origins. Food rations provide only the minimal daily nutritional requirements, unless a punishment is in effect. Uniforms are plain, without adornment or distinction.

A typical day in the life of an Academy cadet begins at 0300 every morning and continues non-stop for the next 18 hours, or until exhaustion sets in, whichever comes first. Such privileges as a cadet may enjoy at the Academy must be won anew every day. These include the privilege of drawing food rations, the privilege of medical attention following a training exercise, the privilege of study-time unmolested by senior classmates or duty officers and, occasionally, the privilege of uninterrupted sleep.

### Klingon Discipline

During their first day at the Academy, all cadets are routinely introduced (some for the very first time) to the dreaded agonizer booth. This 'motivational device' (and the ever-present, palm-sized versions used by instructors and Task Masters) is a constant reminder of the Empire's domination over the individual. To further underline this subservience, no cadet is ever permitted to speak during his or her first year unless first addressed by a senior officer or cadet. In response, the novice will address them as "My Lord".

Klingon discipline, often savage by Human standards, is introduced as a practical matter of course during Prime Learning. Severe penalties are inflicted on individuals for minor infractions or the failure to carry out assigned duties correctly. As a kind of 'political inspiration', it is not unusual for entire sections (and even an entire battalion) to be punished for a single individual's failure to satisfactorily complete assigned tasks.

Because the Academy's administration is traditionally composed only of Imperial Klingons, cadets of Human- or Romulan-fusion are often subjected to racial harassment. There is no recourse against such prejudice but to endure.

During their Prime Learning, cadets are exposed to a wide range of technical and military studies in which they are expected to excel. When not directly engaged in academic pursuits, the cadet will undergo systematic physical conditioning aimed not at strengthening the individual but at breaking his endurance altogether. For example, a senior officer may punish a cadet for no other reason than to test his stamina. The test consists in seeing how long the individual can withstand intense pain before crying out, after which he will be punished for speaking out of turn.

### Selecting The Best

Prime Learning is largely a deliberate weeding-out process. An estimated 40 percent of the recently arrived cadets will be quickly eliminated before the first year is up. Dismissal is usually due to a cadet's inability to complete the rigorous training exercises or to his being suspected of cowardice. In most cases, however, the cowards die first.

Imperial Security may deem an individual unsuitable for further training. Without warning or explanation, the cadet is immediately reassigned to the enlisted ranks. Many of these unfortunates eventually wind up in Klingon Reserve Shock battalions (frozen combat troops housed in hypothermia capsules from one year to the next). For this reason, officers often look upon the enlisted ranks as politically unreliable and racially inferior.

Those cadets who have survived their first year have also earned some meager advantages. Each may now address a fellow cadet (though not an officer as yet) without the need for prior permission. They also receive limited recreational time so that social attachments can be made. A further mark of distinction is the bestowal of a (plain) battle sash.

**"It matters not that I survive, only that which I defend. Forfeit of life, but not of honor."**

—From the Klingon Oath of Empire

During the first months of Prime Learning, cadets quickly establish a well-defined pecking order based on superior strength and cunning within individual Discipline Sections. (This also determines who will be accorded privileges and who will not.)

In the cadet's second year of Prime Learning, academic studies receive greater emphasis, particularly in the sciences. Intense physical and political conditioning are also further stressed. During this stage of their development, cadets are deliberately exposed to inter-unit rivalries as a way of testing their loyalty and discipline.

## SKILL MASTERY

After graduating Prime Learning, the cadet enters Skill Mastery. At this point, the senior officers assign cadets to areas of responsibility, according to the current needs of the service. Cadets begin their specialized training in branches such as Navigation/Helm, Weapons/Defense, or Communications, which may last either two or three years. The individual cadet has no voice in deciding his service branch, and any overt objection to his assignment is grounds for immediate dismissal and reassignment. In any case, such objections are rare.

**"Now, children, the game begins anew. To the *Komerex zha* and all the players in it."**

—Commandant's toast to graduating cadets of  
Klingon Star Academy

Should an individual demonstrate the kind of organizational skills needed by administrators in the Empire's vast, interstellar bureaucracy, the cadet will be removed without warning. No social stigma is attached to the removal, as Klingons recognize the need for competent administrators and managers.

Regardless of their specialty, all cadets undergo small unit combat training (under live battlefield conditions), planetary survival exercises in various simulated climates (unarmed and unaided), shipboard procedures (including simulated combat and emergency conditions), and unarmed combat drills (those judged 'killed' by their opponents forfeit their food ration for the day). By these drills, senior Task Masters seek to hone the skills most needed by a Klingon warrior, even if it costs a few lives in the process.

There is emphasis on political as well as military discipline. Each cadet is subjected to numerous tests of political stability, including the Determinant Factor Exercise. In this exercise, the cadets in a particular Discipline Section are informed that their group has been evaluated as politically unreliable due to the actions of one among them, and that all are facing immediate expulsion. It now falls upon the members of the Section to determine the guilty party. Occasionally, a Section will manage to avoid punishment by rallying some special evidence of their collective loyalty. In other cases, cadets will band together, pledging each other's conduct with their own lives, thus saving themselves as a group. More often than not, however, the Determinant Factor Exercise results in one or more of a Section's members being singled out and offered up as scapegoats to an Imperial Tribunal.

As a reward for diligence and endurance, cadets might be granted the privilege of limited off-duty time away from the Academy. Many use the time to visit their homeworlds, which most cadets are not likely to see again until after their Skill Mastery term is over.

During his last few months of Skill Mastery, each senior cadet is placed in charge of a newly formed Discipline Section (under the guidance and direction of a Task Master, with whom the cadet is allowed the privilege of free speech). The cadet is responsible for the well-being of the younger cadets he now nominally commands. He is also responsible for the cadets' success or failure in performing assigned tasks. The senior cadet is evaluated by his superiors in this regard. In cases where senior cadets fail to sufficiently motivate their sections to acceptable levels of performance, the senior cadet is likely to be the one punished.

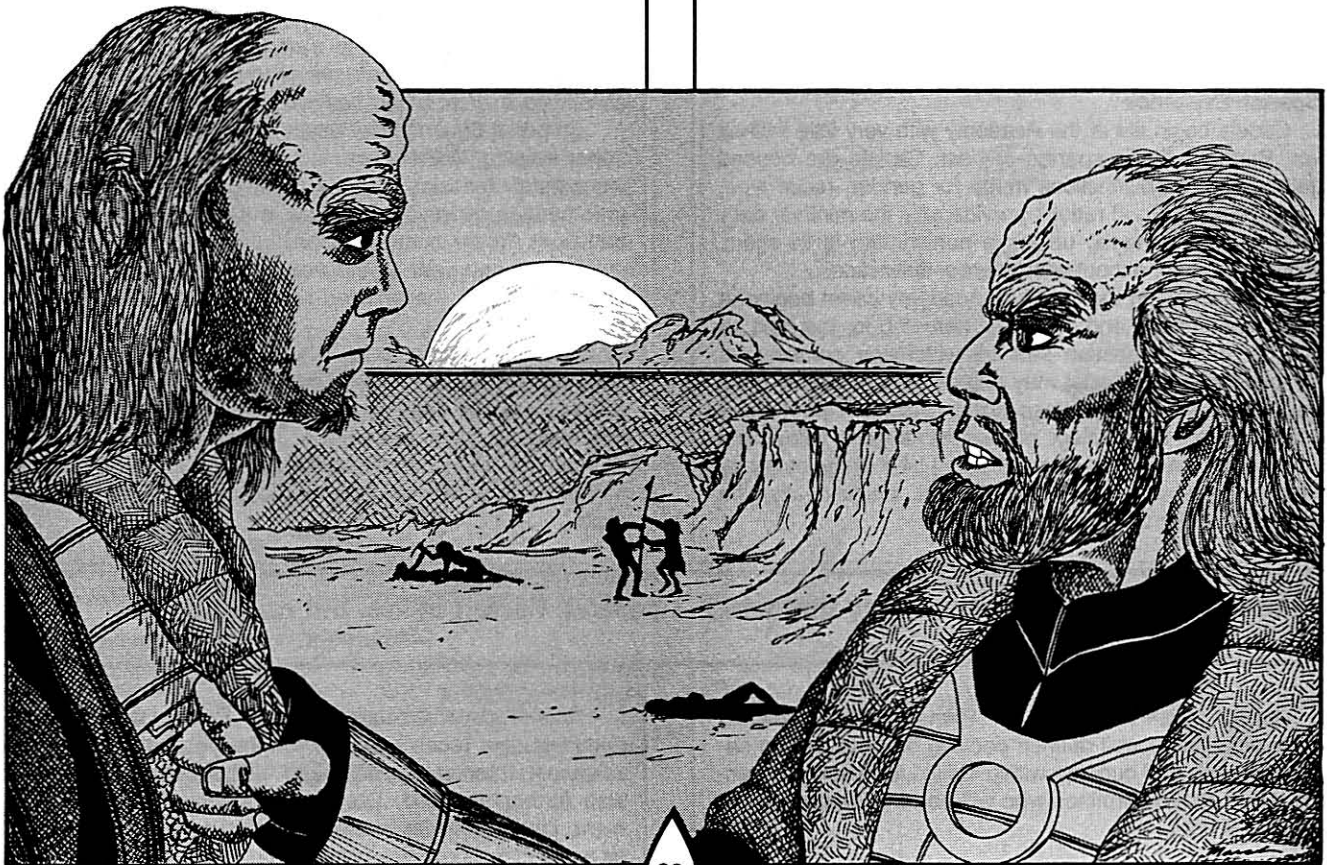

### Final Exercise

The last months of a cadet's life at the Academy are spent in preparation for the final graduation exercise, which is conducted on a group basis. This Academy exercise should not be confused with the student's Skill Application (or cadet cruise), which follows actual graduation. The graduation exercise tests each individual one last time to determine his suitability for the Imperial Klingon military.

The final exercise is, in fact, the cadet's first real duty assignment. Mission Plans for each graduation exercise are prepared by either Imperial Star Command, Naval Intelligence, or Security. Cadets are generally given tasks that require considerable effort to achieve, but that do not call for direct military presence. (Cadets are also considered more expendable than trained veterans, who may be needed elsewhere.)

**"Kai Kassai!"**

—Klingon war cry

### SKILL APPLICATION

Upon graduating the Imperial Star Academy, the newly commissioned midshipman embarks upon his Skill Application, one year of on-the-job training analogous to the Star Fleet cadet cruise. During this time, his superiors and Imperial Security monitor his performance and forward their reports to the Academy for evaluation. Often, a midshipman might spend more than one year in Skill Application, due to poor performance or some remark or action that Security felt was unbecoming of an officer.

### ADVANCED TRAINING

Officers wishing to command a starship or head a department need even further training. The two sections of advanced training are known as *Leaders of Men* and *Leaders of Vessels*.

Like Star Fleet's Department Head School, the *Leaders of Men* training teaches officers to deal with the people and problems within a single department aboard a starship. The *Leaders of Men* positions include Chief Communications Officer, Chief Medical Officer, Chief Navigator/Helmsman, Chief Science Officer, Chief Engineer, Chief of Security, Chief Weapons/Defense Officer, and Marine Battalion Leader.

Building upon the leadership skills taught in *Leaders of Men*, *Leaders of Vessels* training teaches officers starship command and combat skills. Starship Captains and First Officers must attend the *Leaders of Vessels* school.

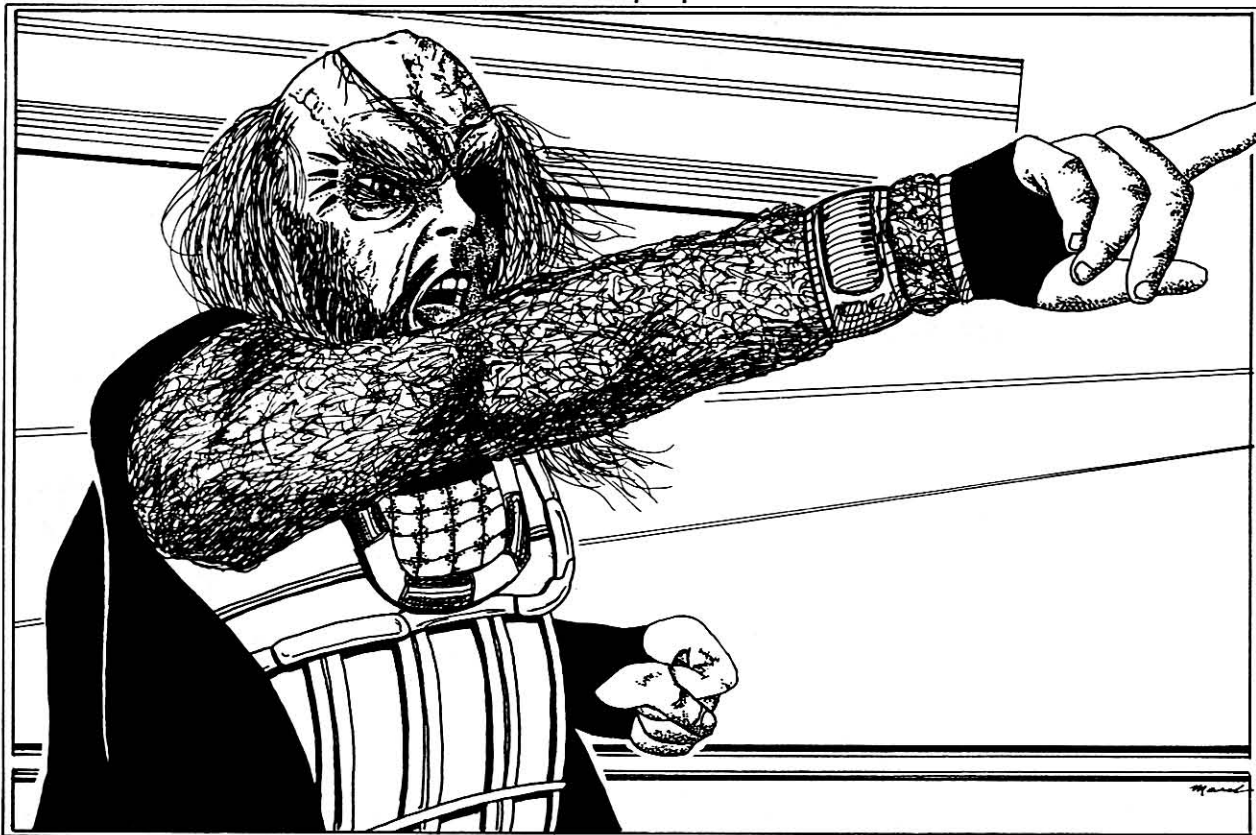

## SHIPBOARD LIFE

—Reprinted from *Klingon Intelligence Briefing*, available from *Star Fleet Intelligence Command* or *FASA*.

Life aboard a Klingon warship is far from the controlled yet flexible environment that characterizes Star Fleet vessels. This is because Klingon naval infrastructure lacks the clear division of responsibility that comes from a well-defined chain of command. Though such a table of organization exists on paper, there are three distinct 'powers' aboard Klingon vessels, each jockeying for advantage at the expense of the other two. This triumvirate is composed of the ship's Captain, the ship's Chief Security Officer, and the ship's Marine Commandant. When these personalities conflict, one party may take action to eliminate one or both of his opposite numbers. Regardless of whether he succeeds or fails, the result is a divided crew and the risk of mutiny.

Even under the best of circumstances, there is always an underlying level of tension among Klingon crewmembers. In addition to interracial hostility, conflicts can erupt over real or imaginary insults between houses, division of duty assignments, crowded living conditions, and lack of proper recreation. Further, ship's security carries out constant surveillance of all officers and crew, regardless of rank or gender, and they are only too eager to report anyone who is not 'sufficiently motivated' politically.

The majority of Klingon vessels lack the necessary space and trained specialists to provide adequate care for the sick or injured. Cramped living quarters shorten crewmembers' tempers, and personal combat challenges are commonplace. During the course of an assignment, the typical ship's Captain will lose about three to five percent of his crew to personal combats.

In summary, vessels in the Imperial Klingon Navy are prime examples of *komerex zha*. Once ship combat becomes imminent, the Captain whips his men into a frenzy by using a special battle language. Klingons view every combat as a potential life and death situation, and so failure to respond to a command is tantamount to treason, punishable by immediate execution by the Captain or his designated subordinate. Some Captains employ special female command staff solely for this purpose, though the reason for choosing females is not known.

## STARSHIP RECOGNITION FILE

Complete details on known Klingon starships are available in the **Klingon Ship Recognition Manual** available from Star Fleet Intelligence or from FASA. This book will focus only on the several types of Klingon vessels commonly encountered along the Organian Treaty Zone, the Neutral Zone, and in the Triangle. All Star Fleet officers serving in areas near Klingon space should be able to identify these vessels on sight and know something of their operation history.

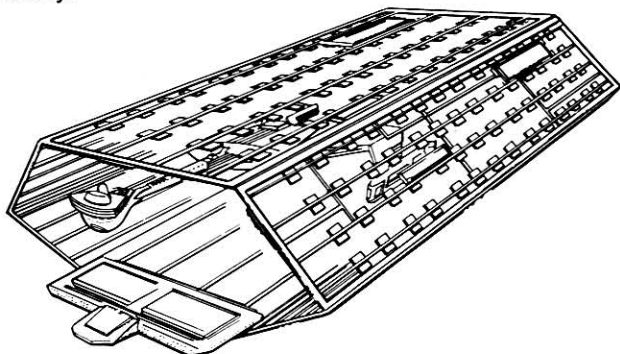

## D-7 CRUISER CLASS VII—IX

### Construction Data:

Model Numbers—	Various
First Seen By Federation—	1/87
Number Constructed—	3,090

### Hull Data:

Size	
Length—	215 m
Width—	150 m
Height—	55 m

### Other Data:

Weight—	100,000 mt
Crew—	550

### Combat Data:

Known Top Speed—	Warp 9
Known Armament—	Disruptors (some also have photon torpedoes)
Beam Weapon Type—	Medium
Number—	4 to 6
Firing Arcs—	forward, port, starboard
Missile Weapon Type—	Torpedo
Number—	None or 1
Firing Arcs—	forward

**Notes:** The *D-7* is the most frequently encountered vessel in UFP/Klingon contact history, and so most experts agree that it is probably the most numerous in service. Federation vessels first met the *D-7* during the Four Years War, and the ship continues in service to this day. Star Fleet has identified at least four different types thus far.

Variations between models is slight, which makes visual identification difficult. This caused problems earlier when overconfident Star Fleet commanders mistook a vessel as an easy victory, only to discover later that they were actually confronting a much stronger ship. The few instances where UFP vessels have encountered a *D-7* equipped with rear-firing disruptor have given Star Fleet officers a new respect for the cruiser.

The biggest surprise was a *D-7* that mounts a powerful torpedo both fore and aft, which is the type most recently encountered. This vessel is at least as powerful as the *Constitution* Class, if not stronger. Latest intelligence reports also indicate that a fifth version of the *D-7* may be operating in the Triangle area.

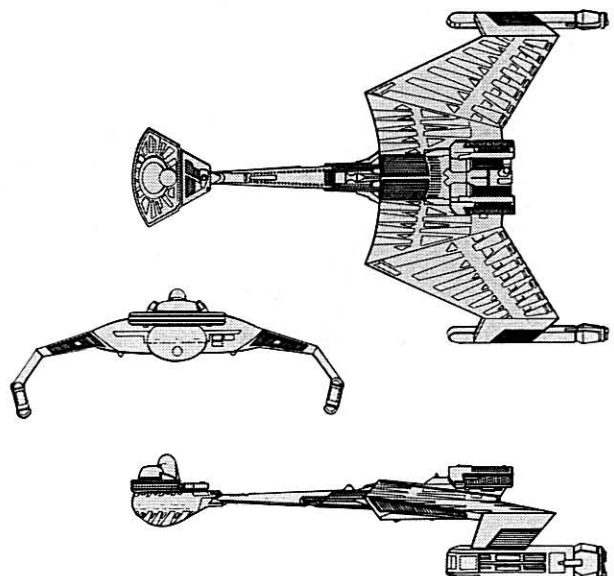

### D-10 CRUISER CLASS VIII —X CRUISER

#### Construction Data:

Model Numbers —	Various
First Seen By Federation —	1/96
Number Constructed —	1,030

#### Hull Data:

Size	
Length —	265 m
Width —	155 m
Height —	30 m

#### Other Data:

Weight —	140,000 mt
Crew —	520

#### Combat Data:

Known Top Speed —	Warp 8
Known Armament —	Disruptors (some also have photon torpedoes)
Beam Weapon Type —	Medium to heavy
Number —	8 to 10
Firing Arcs —	All sides
Missile Weapon Type —	Torpedo (possibly plasma also)
Number —	1 or 2
Firing Arcs —	forward, aft

**Notes:** The Federation first encountered the *D-10* during the Four Years War, and has found it to be one of the deadliest vessels ever met. Though these first *D-10*s were not equipped with missile weapons, they were formidable nevertheless. Had Star Fleet not been able to develop superior tactics, that war might have ended differently.

The second type of *D-10* encountered by Star Fleet is much more powerful because of its fore- and aft-mounted torpedoes. After the Federation captured two of these vessels fairly intact, extensive research into Klingon construction techniques became possible. Star Fleet carried out weaponry trials, not only to evaluate present Klingon technology, but to forecast where that technology might be headed.

Rumors surfacing in the Triangle indicate that the Klingons may have mounted a Romulan-type plasma weapon on the *D-10*, but the reports are unconfirmed. If such a vessel does exist, this third type of *D-10* will indeed be a formidable foe at close range, especially if it retains the torpedo weaponry.

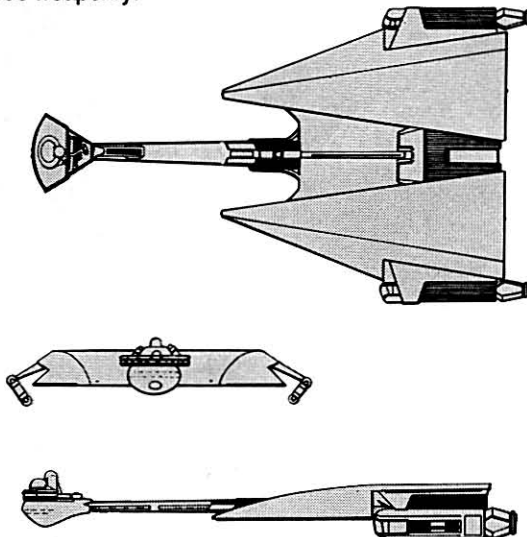

### D-18 (GULL) CLASS VII —IX DESTROYER

#### Construction Data:

Model Numbers —	Various
First Seen By Federation —	2/03
Number Constructed —	670

#### Hull Data:

Size	
Length —	215 m
Width —	160 m
Height —	40 m

#### Other Data:

Weight —	125,000 mt
Crew —	250

#### Combat Data:

Known Top Speed —	Warp 9
Known Armament —	Disruptors
Beam Weapon Type —	Medium
Number —	2 to 6
Firing Arcs —	forward, port, starboard
Missile Weapon Type —	Torpedo
Number —	None, possibly 1
Firing Arcs —	Aft

**Notes:** It is assumed that the *D-18* is the most widely used destroyer in the Klingon Navy. Reports of its use surface everywhere the UFP has contacts, including the Triangle. This vessel, known as the "Gull" in the Federation, was first observed in the Triangle shortly after the Four Years War.

Star Fleet managed to capture and evaluate one of these early types. Equipped with only two disruptors, the vessel at first appeared to be a survey ship. Later meetings with a more heavily armed version have clouded the issue, however. This second model was the variant most often encountered, and is believed to be in use today. The Kargon incident is the most famous instance of Federation contact with the Klingon *D-18*. In the incident, a task force of six *D-18*s attacked a Federation outpost in the Orion sector. Star Fleet reinforcements arrived in the form of the *Kongo*, a *Constitution Class* vessel escorted by two *Loknar Class* frigates, the *Halk* and the *Rome*. The Klingons destroyed all three UFP vessels.

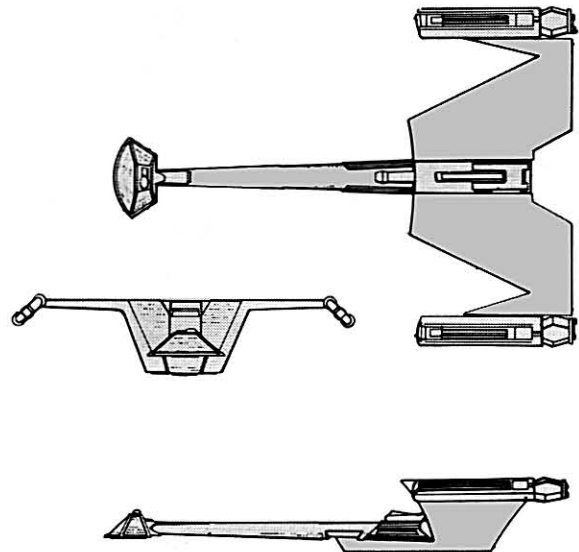

### K-23 (LITTLE KILLER) CLASS VI—VIII ESCORT

#### Construction Data:

Model Numbers —	Various
First Seen By Federation —	1/97
Number Constructed —	1,245

#### Hull Data:

##### Size

Length —	195 m
Width —	140 m
Height —	40 m

#### Other Data:

Weight —	85,000 mt
Crew —	175

#### Combat Data:

Known Top Speed —	Warp 8
Known Armament —	Disruptors
Beam Weapon Type —	Medium
Number —	2 to 4
Firing Arcs —	Forward, port, starboard

Missile Weapon Type —	None
-----------------------	------

**Notes:** Not until Star Fleet captured and examined several of these vessels did it learn that they were Klingon rather than Romulan ships. Thus far, the Federation has captured three different models in border skirmishes and in the Triangle. Intelligence has unconfirmed information that there may be as many as four more variants of the K-23 that the Federation has not yet encountered. These are said to be upgunned to the point of being functional destroyers.

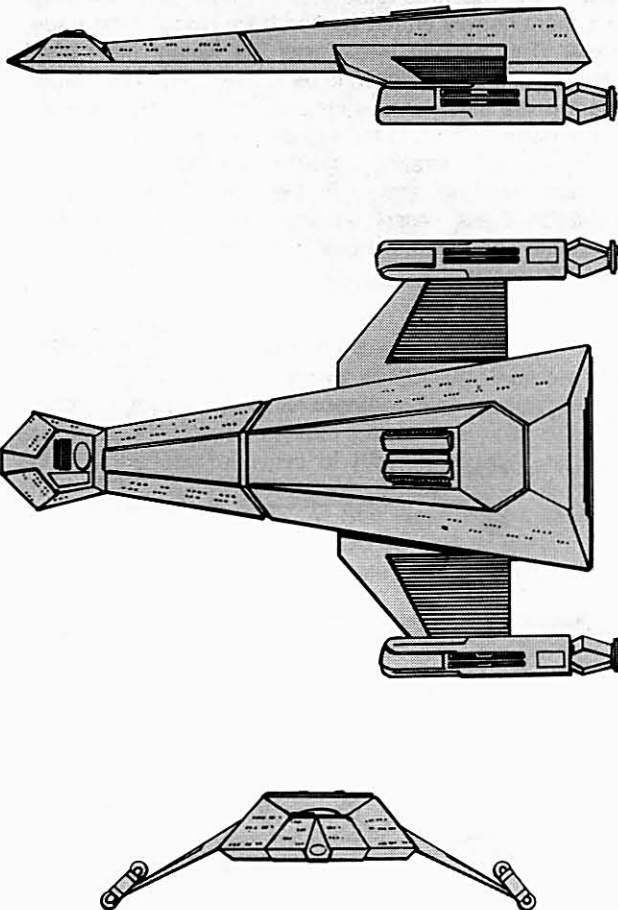

### D-32 (STRONGER BIRD) CLASS VII CRUISER

#### Construction Data:

Model Numbers —	Various
First Seen By Federation —	2/21
Number Constructed —	40

#### Hull Data:

##### Size

Length —	110 m
Width —	160 m
Height —	20 m

#### Other Data:

Weight —	80,000 mt
Crew —	175

#### Combat Data:

Known Top Speed —	Warp 9
Known Armament —	Disruptors and photon torpedoes
Beam Weapon Type —	Medium or heavy
Number —	4 to 8
Firing Arcs —	All

Missile Weapon Type —	Plasma or photon
Number —	1
Firing Arcs —	Forward

**Notes:** One of the newest ships in the Klingon fleet, the D-32 is rumored to be a joint design, or possibly a design exchange, with the Romulans. The cruiser's wings may be locked into one of three positions. In the attack mode, the wings are down, while for flight, they are straight out from the hull. The wings go up for landing planetside. Little else is known about this new vessel.

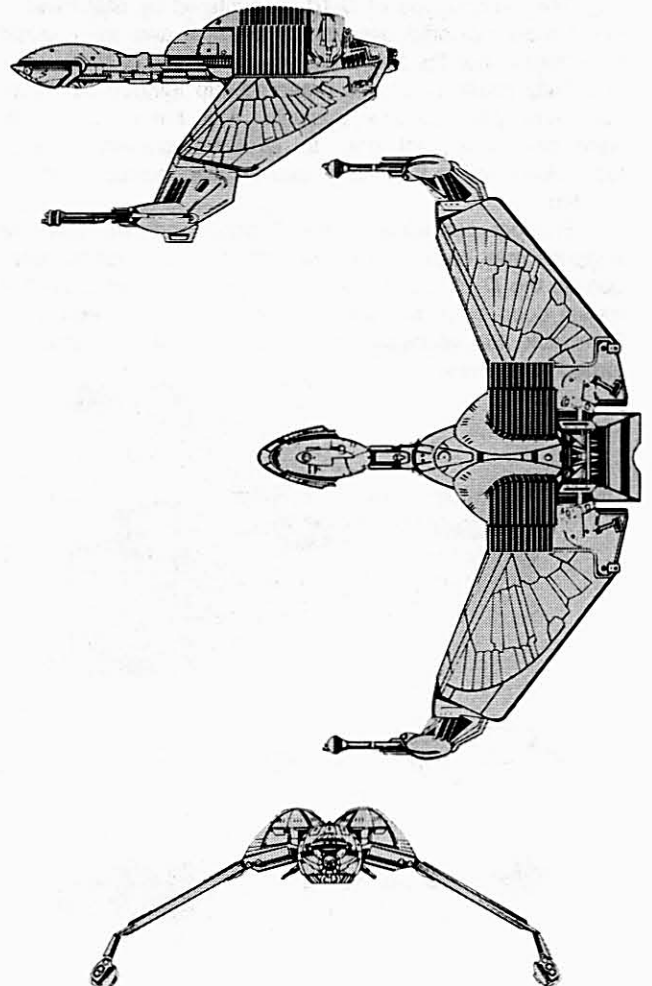

## KLINGON STARSHIP TACTICS

[EDITOR'S NOTE: The following summarizes what is known about Klingon starship tactics. More detail appears in FASA's *The Four Years War* and *Klingon Intelligence Briefing*.]

Star Fleet officers can expect Klingon warships to operate either individually or as a loosely knit group of three ships. Though their ship-to-ship tactics are often subtle and well-conceived, battle coordination among vessels is poor. For example, a mass assault inevitably degenerates into a frontal attack using everything the Klingons can muster.

More often than not, Klingon forces preparing to attack a planet or planetary defense system approach along the plane of the planetary system's ecliptic, or 'level' with the other planets, rather than coming in from 'above' or 'below' the intended planet. They use this maneuver because it allows their vessels to take cover in asteroid or cometary belts.

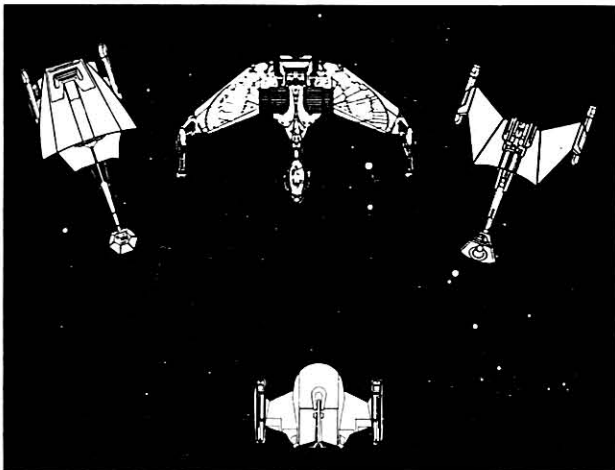

A squadron of three Klingon ships generally employs a V-formation, with the center ship (usually the group's flagship) up to 40,000 kilometers in front of, or behind, the other ships in the formation. When the flagship leads the squadron, the Klingons call the formation *oma' yuth* ("brave wedge"), and when the flagship trails, they call the formation *hu toj maal* ("open mouth" or "mouth of fear"). On rare occasions, Klingon squadrons line up in a diagonal formation called *juk'y wen'thal* ("ladder of assault").

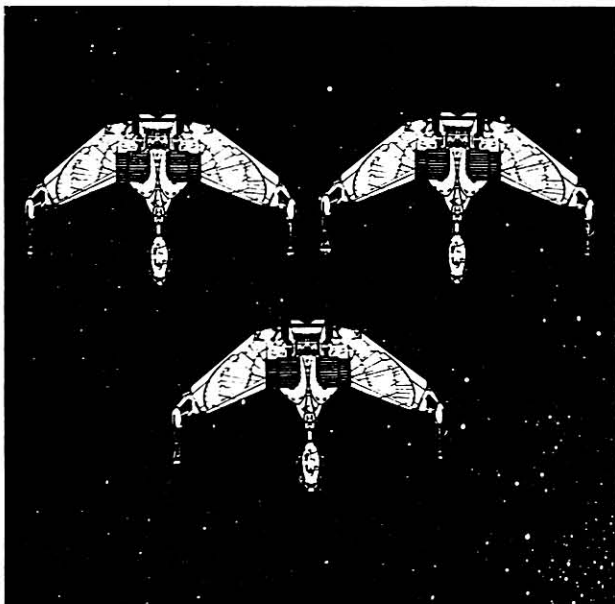

Klingon warships with forward- and aft-firing systems commonly employ the tactic called *eddakh w'ujalla* ("striking for the spleen"). While battling an enemy ship, the Klingon deliberately leaves his ship open for a flanking attack. As soon as the enemy ship enters the Klingon's rear arc, the Klingon ship opens up with his aft disruptors, taking the enemy commander by surprise. Star Fleet officers are encouraged to study Klingon ship design so that they can recognize Klingon ships with aft-firing weapons.

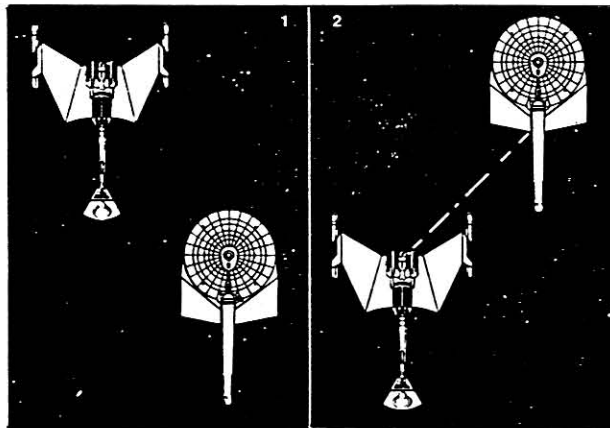

Admiral zantai-Kaneida has employed a tactic called *v'kari z'mortamas* ("many stings of death") with considerable success. A swarm of gunboats overwhelm the opposing ships' fire control systems and shields, while heavy fire from Klingon cruisers easily penetrates the enemies' defenses.

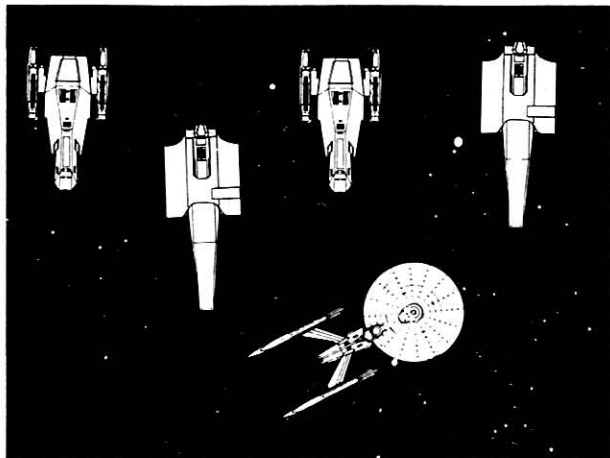

Though most defensive formations are created as the situation develops, the Klingons sometimes use a defense called *hul fal tora'n* ("glorious exploding star") to gain a single-unit engagement with enemy ships or to mislead the enemy about the destination of a task force. The only thing Star Fleet commanders can do after Klingon ships warp out in different directions is to laboriously track down and neutralize each Klingon ship, one at a time.

Deceit is another favorite Klingon ploy. Klingon commanders have been known to use false ship recognition signals, decoys, and fake distress calls to lure enemy ships into traps.

Captured Klingon vessels reveal surprisingly effective targeting devices. In combat, however, the weaponry lock-on equipment seems to perform erratically, with Klingon ships occasionally hitting each other! This usually occurs after an attack, which may indicate that the equipment tends to overheat or is in need of repair.

## THE IMPERIAL MARINES

### ORGANIZATION

The organization of the Imperial Marines appears to be similar to that of the UFP ground forces. The major difference is that Klingon Marines seem to be an integral part of the crew of nearly all large combat vessels. This indicates that the Klingons can fight a dirt-side battle without having to call in special vessels equipped for transport, as does the UFP.

Aboard the larger vessels, these Marines are organized into battalions, which seem to be the primary independently commanded units. When circumstances dictate larger actions, the Klingons band several battalions together into regiments or brigade-sized units. For tasks such as long-term occupation, the Klingons usually bring in less-well-trained units to free up the Marines for other duties. Star Fleet draws this conclusion from the fact that when supporting combat vessels leave an area, they generally take the Marine units with them.

### RANK

Star Fleet Intelligence indicates that Klingon Marine rank titles and duties are almost identical to Star Fleet Marines. The title of *General* is a generic term for an officer above the rank of *Colonel*, as is true with the naval rank of *Admiral*. A *Force Leader* is in command of one ship's complement of Marines, no matter the size of the group.

### WEAPONS AND TACTICS

[EDITOR'S NOTE: Space limitations dictate that this topic be summarized only briefly. Officers are referred to both *The Four Years War* and *Klingon Intelligence Briefing*, available from Star Fleet Intelligence Command or FASA.]

Klingon Marines carry hand weapons almost identical to those of their Naval counterparts. Larger weapons are very similar to those used by the Federation, including vehicles. The primary difference is that UFP weaponry can generally fire on several different settings, while the Klingon heavy weaponry is designed to be as destructive as possible, with no lower settings available. Federation weapons allow their users to show some restraint in causing damage, but this does not seem to concern the Klingons at all.

Klingon ground force tactics are very simple. The Klingons will beam as many troops as they can into an area as fast as they can, showing no regard for possible loss of lives due to signal jamming. They generally beam directly into the target area. Then the Klingons hold the objective, using it as a base from which to work outward. Though these attacks seem suicidal, they are effective, in a crude way.

**"Beyond contempt is the willing slave,  
for he deserves his destiny."**

—Klingon proverb

## KLINGON DIPLOMATIC CORPS

The Klingon Diplomatic Corps, or KDC, is a major component of the Imperial Contacts Branch, or ICB. This organization is a very thin cover for a group dedicated to bringing worlds under control by any nonmilitary means available. These means include peaceful negotiations, assisting a party already in power or placing a party in power, terrorist operations, weapons sales, and so on.

By handing a dissident group the reins of government, the Klingons make that group indebted to and dependent upon them to keep its power. The Klingons become so entrenched that the new government cannot exist without their aid. Besides, if the newly powerful group does not cooperate, the Klingons can simply replace it with another. The KDC also sets up false incidents that it uses to justify Imperial intervention. For example, pirates captured in the Triangle have turned out to be funded by the KDC, often with KDC agents aboard the captured vessel.

Behind the scenes is where an estimated 90 percent of the KDC operates. The other 10 percent are real diplomats, carrying out actual diplomatic missions. After all, true diplomacy is much cheaper when it works.

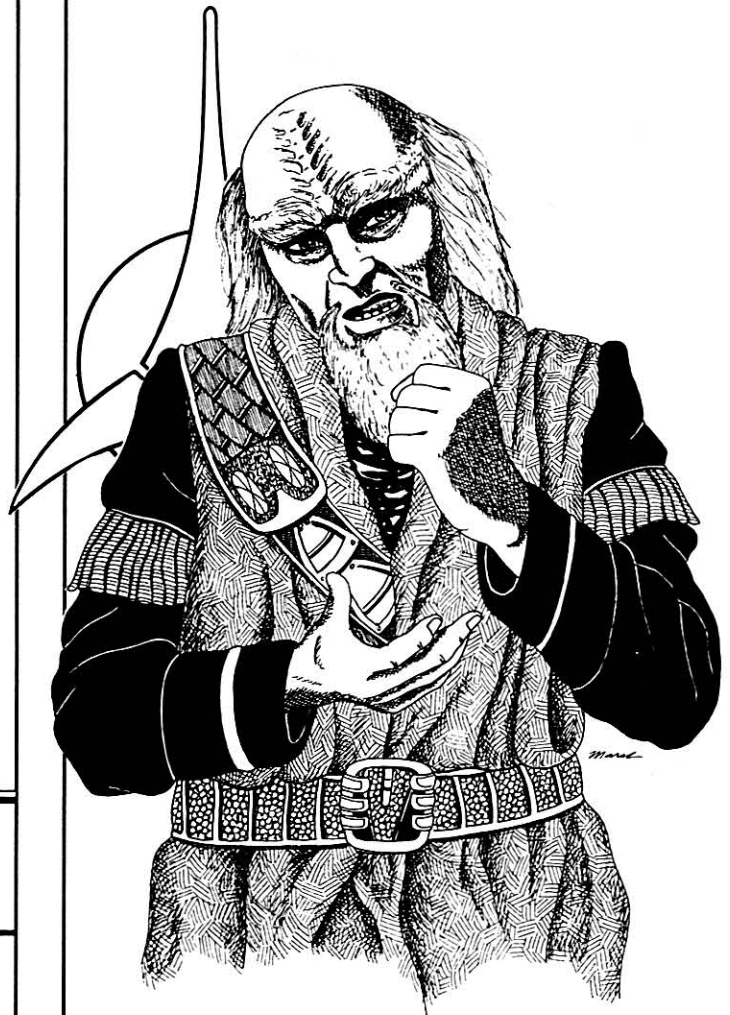

# EQUIPMENT

—Prepared by Major Lynn Greene, Foreign Equipment Specialist, Quartermaster's Office, Star Fleet Marine Corps

In many ways, Klingon equipment parallels Star Fleet equipment. Though the appearance and operation may be different, the underlying principle is often the same. The four major types of Klingon equipment are **Personal Equipment, Vehicles, Medical Equipment, Weaponry, and Ship-board Systems.**

## PERSONAL EQUIPMENT

This section describes many of the items that the average Klingon Naval or Marine officer might commonly carry. In some cases, these items function identically to Star Fleet equipment. (See also the STRPG2 **Cadet's Orientation Sourcebook.**)

### ANTIGRAV, PORTABLE

These function like Federation antigrav units. They are small, hand-held devices used to move heavy equipment easily from place to place by cancelling the equipment's weight. Objects attached magnetically to an antigrav can be 'hung' in mid-air, unsupported. One antigrav can cancel up to 100 kilograms of mass. Several may be used to move heavier items. Antigravs cannot be set to produce a negative gravity effect.

### AQUALANTERN

This unit functions like its Federation equivalent. It is a small, hand-held light source safe for use underwater. It produces a ten-meter radius of light.

### BATTLE COMPUTER

Klingon field commanders use this small, portable computer display to assist in pinpointing enemy locations. When given specific terrain characteristics and tied into a tricorder, the computer can pinpoint the location of enemy troops, the presence of any energy weapons, and a plot of likely enemy movements.

### COMMUNICATOR

The standard Klingon communicator has a flat silver case with a T-shaped back and a red plastic cover. The cover is hinged and flips up, though it is neither the antenna nor the on/off switch, as in the Federation version.

When opened, the communicator has three function selection pads set above a three-digit, LED-type display. Below that are two telltales indicating transporter lock-on (left LED) and frequency scrambler on/off status (right LED). Set between these two LEDs is a triangular speaker grill. At the bottom of the panel is a dial for frequency shift/gain. Note that the digital LEDs are twelve-segment LEDs for representing Klingon alphanumeric characters. The Federation uses seven-segment LCDs in digital watches, calculators, and readouts.

The communicator serves for both person-to-person (over line-of-sight distances) and person-to-ship communications. For the latter, the personal communicator has a

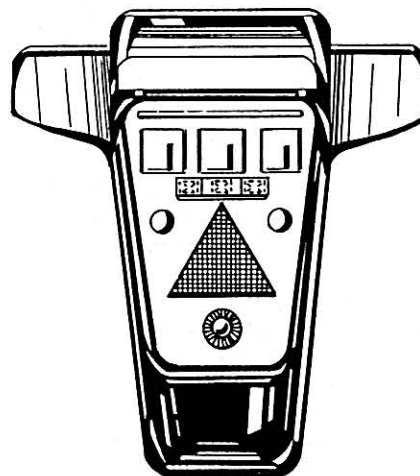

range of about 26,000 kilometers. The signal may be blocked, however, by atmospheric disturbances, intervening terrain such as mountains, or dense materials. In addition to its function as a transceiver, the Klingon communicator can be set to detect energy sources up to 500 meters away. This scan can only tell the presence of, but not the intensity or nature of, the energy source.

There is no on/off switch on the communicator. In fact, the unit is on all the time. When not actually in use, the unit will enter a standby mode that uses very little power. The communicator is thus always open to receive, no matter what the circumstances. In operation, it calls its user by emitting a soft tone.

The final function of the device is for transporter signal lock-on, which is also true for the Federation unit. When the transporter has locked on the user, the left-hand LED will glow red.

### COMPUTER/RECORDER, PORTABLE

The computer/recorder is a small (6 cm x 28.5 cm x 11.6 cm) case with a collapsible handle on top. It opens to reveal a keyboard on the lower half and two screens on the upper half. The left screen is for text only, while the right screen is for graphic applications. This separation of function allows both to be used at once in some cases.

The standard-type data cart plugs into an opening at the right; these are the same carts used by all Klingon-manufactured computers. On the end opposite the cart slot is a microphone and video lens. These are only active when the unit is closed. When the user points the closed unit toward a subject and presses the record button located just in front of the handle, the machine will record about one hour of sound and video onto the cart. This recorded data may be played back and/or processed in either the computer/recorder or any other Klingon-manufactured computer.

### ELECTRONIC DIARY

This device is about the size and shape of a hand calculator, and will record personal log entries as well as receive instructions from senior officers. A Klingon starship communications panel can transmit data into its memory without making direct contact (and vice versa).

### ELECTRONIC TRACER/TRANSDUCER SET

The tracer is a small, palm-sized metal sphere resembling a flattened coin. The transducer comes in a variety of shapes, but usually looks like a fabric fastener or metal clip. The tracer can home in on a signal transmitted by the transducer, which is carried by (or planted on) another individual. Once the transducer is activated, the tracer can pick up the signal from as far as 50 kilometers.

### EMERGENCY PACKAGED RATIONS

Though similar nutritionally to their Federation counterparts, these Klingon emergency rations were not designed for anything as frivolous as good flavor. Indeed, they have the same consistency and taste as dried wood pulp.

### ENVIRONMENTAL SUIT

Though these suits differ in appearance from those used by the Federation, they are almost functionally equivalent. The one major difference is that Klingon suits are not self-sealing. Klingon command reserves this frill only for the deluxe officer's suit. A patch kit is usually carried on the belt. For more information, see the **Cadet's Orientation Sourcebook** in STRPG2.

### HOLOCUBE

This small (50-millimeter) cube can display a three-dimensional image of a person or object. More sophisticated holocubes can project a short series of repeating images.

### I.D. CARD

The Klingon version of the I.D. card is somewhat smaller than the Federation version and attaches to a monofilament cord that hangs around the neck (similar to the way 20th-century Terran soldiers wore dog tags). The two ends of the cords attach simply by touching them together, and separate just as easily. In all other respects, the Klingon I.D. card is identical to the Federation cards. (See also the **Cadet's Orientation Sourcebook**.)

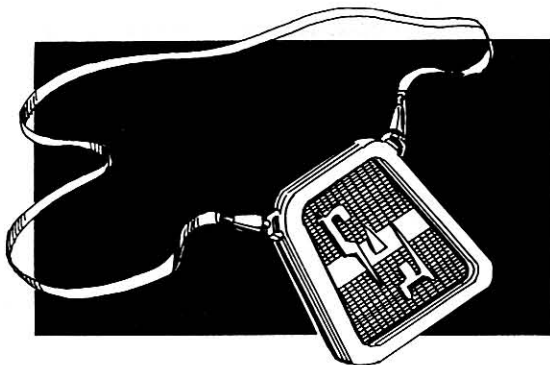

### INSTRUCTIONAL MACHINE

To use the instructional machine, the user places the metallic, helmet-shaped device on his head and inserts a computer cart into the briefcase-sized control box. Such carts contain programs ranging from skill learning to inspirational indoctrination. Though generally used for propagandizing by force and crash-learning, the machine also acts as a torture device if no programming cart is inserted.

### LIFE SUPPORT MASK

The Klingon life support mask is larger than the Federation model, covering the wearer's eyes as well as the nose and mouth. It has a small (7.5 by 3.75 centimeters in diameter) cylinder mounted just below the mouth.

The Klingon life support mask is designed to filter out mildly toxic gases or to provide a short-term (ten minutes) portable air supply. In a very thin environment, the wearer can set the mask to use what oxygen there is, and supplement that oxygen with its own supply. This stretches out the oxygen supply proportionately longer. The cylinder is easily replaced, and may be changed while the mask is in use. Special valves seal off the unit until the new cylinder is in place.

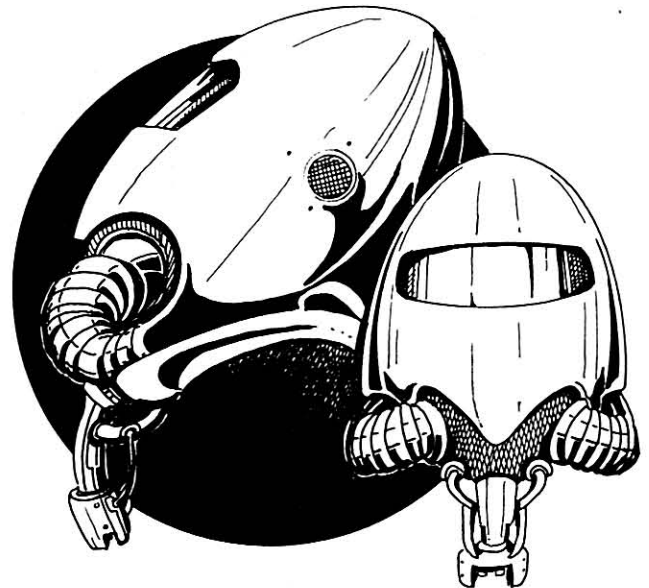

### MAGNESIUM HEAT CAPSULE

This small, flat, dull-grey tablet contains a magnesium center and an active phosphorus coating. When struck squarely by a heavy or sharp object, it will flame up, producing a great deal of heat and light for about five minutes.

### PERSONAL SURVIVAL KIT

Designed for one person, this kit contains the following: one small saw-toothed knife, emergency rations in concentrate form (adequate for up to 72 hours), a pain-blocker capsule, a twelve-pack of magnesium heat capsules, three coldlight glowsticks (which emit 'cold light' of a greenish hue for about ten hours), and one-third liter of water.

### POCKET SCRAMBLER

This device generates a static field that blocks out various security surveillance systems within a ten-meter radius. Security sensors or tricorders that detect visual or voice readings will encounter extreme interference when this device is in use.

### PORTABLE SHIELD GENERATOR

This field version of a ship's deflector shields provides added protection to troops. Though ineffective against ship-based weaponry, portable shield generators do provide limited protection against hand-held weapons. They have a limited power supply, but can be recharged via microwave link with an orbiting ship.

### SMALL-EQUIPMENT ENERGY CELL

Klingon electronic equipment uses a variety of small rechargeable and non-rechargeable energy cells, ranging in size from a 20th-century Terran watch battery to a AAA battery. They have an indefinite shelf life.

### TRICORDER

Klingons use a tricorder-type device so similar to the standard Federation sciences tricorder that it is almost certainly a copy of a captured design.

### UNIFORM

The Klingon standard uniform consists of a durable black jumpsuit, armband, and the leather vest with the three bars on the left side of the chest. This vest provides excellent protection against daggers and edged weapons. A wide black belt with large brass buckle encircles the vest. A high brass collar is worn around the neck, and rank insignia is worn on its left side. Fingerless leather gloves and high black leather boots complete the uniform.

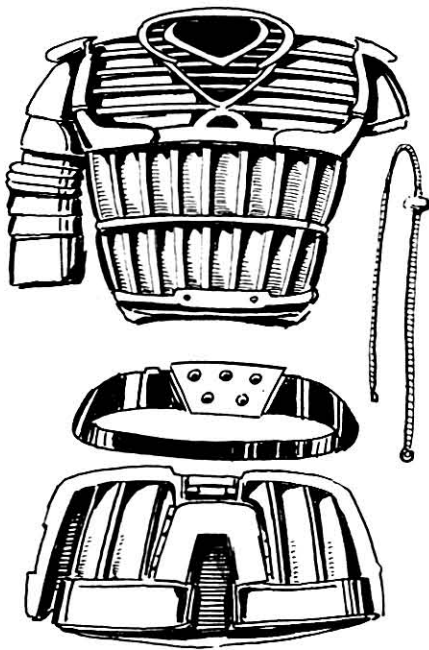

### UNIVERSAL TRANSLATOR

The universal translator is a silver-colored device that hangs from a belt, and translates the bearer's speech as well as the audience's. There is a microphone on the front to receive the audience's speech, and a speaker on either side to broadcast what the bearer says to the audience. With the unit also comes a small throat microphone and a small receiving earphone. These *must* be used with the device. The throat microphone is adhesively attached to the user's throat, and transmits his voice to the device. As the unit translates the audience's speech, a signal is transmitted to the earphone. There are no connecting wires between the universal translator and either its microphone or earphone.

Unlike the Federation model, Klingon translators must be individually programmed for the language to be translated. In the lower front of the device, there is a small plug for a *language chip*. This chip contains the working language needed, and may be replaced by any other language chip in a moment. Using a programming cart, these chips can be programmed from any large computer. The programming cart looks very much like the data cart, but has a slot for the language chip at the end opposite the one that plugs into the computer. The programmer is then plugged into the data cart slot of the computer containing the language. Only one language may be stored in a language chip at a time.

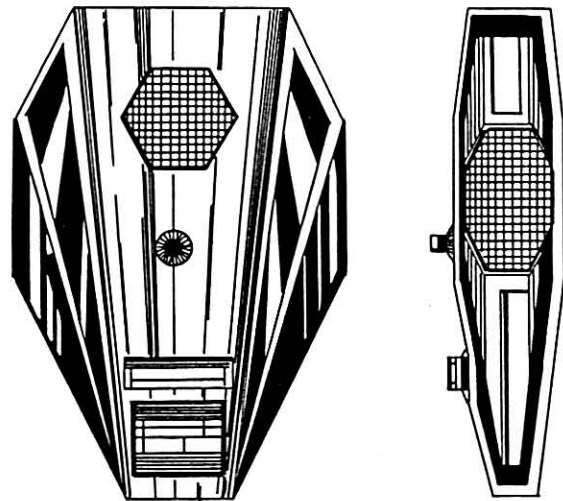

## VEHICLES

Both of the following ground vehicles are powered by the standard Klingon vehicle fusion engine. Oddly, both lack any sort of weaponry.

### MODEL GP-12 ALL-TERRAIN VEHICLE

A standard, all-purpose vehicle, the GP-12 is a six-wheeled, all-terrain vehicle generally used for light transport, scouting work, or even as a command car. It can hold up to five individuals plus a driver.

### MODEL GP-6 UTILITY VAN

The GP-6 wheeled utility van is the workhorse of Klingon marine landing forces. Able to haul up to ten metric tons of supplies and equipment, the van can also tow another vehicle or a trailer, if necessary.

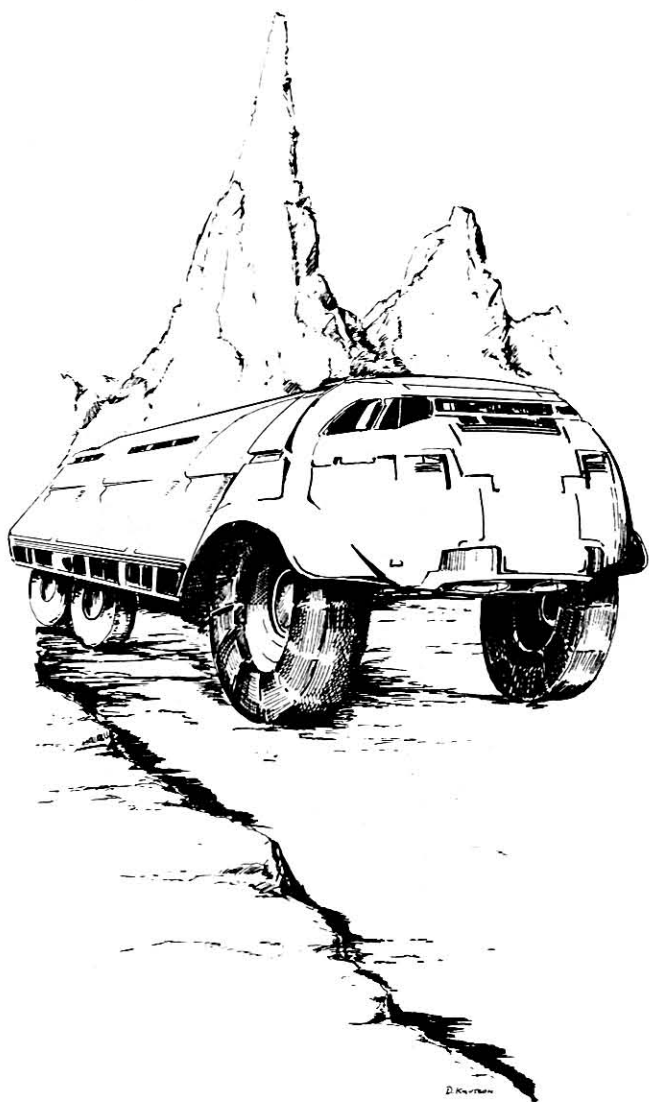

## MEDICAL EQUIPMENT

This section includes descriptions of the most common medical equipment available to the Klingons. In many cases, where the equipment is similar to an item used by the Federation, refer also to the STRPG2 *Cadet's Orientation Sourcebook* for more detail. Though these pieces of equipment may not resemble their Federation counterparts at all, their function will be exactly the same unless otherwise noted.

### BIOSUPPORT AND MONITOR SYSTEM

The biosupport and monitor system is a large box with sensor cables, intravenous tubes, and a large cable tipped with a standard data cart connector. The latter plugs into either a portable computer/recorder or into a larger computer's data cart slot. The device has a number of functions, ranging from supporting massive-trauma patients to sustaining prisoners undergoing traumatic torture. The system monitors vital signs and supplies support suggestions. It also contains a large supply of drugs, which can be administered automatically in an emergency. The operator can override this last feature at any stage, however.

### DIAGNOSTIC/SUPPORT TABLE AND PANEL

Although these units function similarly to Federation models, they have programmable alphanumeric displays rather than the more familiar vertical slide scales. In addition, there are programming pads and support boxes mounted on either side of the bed for programming and/or retrieving medical data. These can also supply any drugs needed to maintain the patient.

Similar tables are also used in Klingon operating rooms. These versions are equipped with surgical benches that duplicate the functions of the support boxes of the wardroom version. In addition, there are surgical instrument trays that swing out for use. These contain both modern instruments and emergency backup equipment such as bladed scalpels.

### FOAM DRESSING APPLICATOR

This differs from the Federation spray dressing only in appearance. When the unit is empty, screw-cap disposable refills are available.

### LASER SCALPEL

The Klingon laser scalpel is long and pencil-shaped, with a small, rechargeable power supply that plugs into the top end. A fully charged power supply will last about three hours of continuous use. Seven beam widths are available: 000, 00, 0, 1, 2, 3, and 5.

## MEDICAL POUCH

This pouch contains everything that a Klingon doctor is likely to need: one foam dressing applicator, a vital signs reader, an organic suture, two laser scalpels, a pneumatic hypodermic, two spare pressure cylinders and nine medicine cylinders containing light and medium sedatives, light and medium stimulants, a general purpose poison antidote, a pain-blocking drug, a pain-enhancing drug, a truth drug, and an endurance booster.

## ORGANIC SUTURE

Klingon medical personnel use an organic suture to close wounds, while Federation medics use a protoplaser. The organic suture extrudes a very fine organic fiber, which is then literally knitted into the wound by two small arms—much like a spider spins its web—to seal the wound. As the wound heals, the patient's body simply absorbs the organic fiber. In the back is a small reservoir that holds enough fluid to last for about 30 minutes of continuous use.

## PNEUMATIC HYPODERMIC

The pneumatic hypodermic is a flat object shaped much like a bar of soap. It has two chambers at one end for the insertion of one medication cylinder and one air cylinder. At the opposite end is a wide screen; this is the injector. The large upper surface has a slide for selecting the proper dosage, a push-button trigger for injecting the medication, and a two-digit, 12-segment LED (see the Klingon Communicator) that tells the amount of medicine remaining in the medicine cylinder.

Each full medication cylinder contains ten units of medicine. The hypodermic can inject up to two units at a time, but one unit is the normal dose for a Klingon. The air cylinder contains enough pressure for about 50 injections.

## VITAL SIGNS READER

The vital signs reader is a hexagonal-shaped object about 20 millimeters across and 12 millimeters thick. On the top surface, it has a two-digit, 12-segment LED (see the Klingon communicator) and two control buttons. One of the six sides is a recharge socket similar to that of a laser scalpel. On the bottom surface is a sensor pad. A full charge on the vital signs reader will last about ten hours of regular use.

The Klingon vital signs reader is not quite as handy to use as the Federation Medical Feinberger. The medic must press it, sensor pad down, against the patient's skin, and then he depresses one or both buttons. Pressing the left-hand button reads out the heart rate of the patient, and pressing the right-hand button gives the patient's respiration rate. Pressing both buttons at the same time gives the patient's blood pressure.

## DRUGS

Klingon medical personnel have drugs similar to those available to the Federation, as described in the **Cadet's Orientation Sourcebook** of STRPG2. In addition, they also have the following chemical agents at their disposal.

### Chlortheragen

This lethal nerve gas, which causes excruciating pain before killing its victims, was first used as a chemical agent against Federation ground forces during the Four Years War. Though the Federation developed an antidote for chlortheragen, it is still used widely for crowd control on Klingon worlds and colonies.

## Endurance Booster

Under the influence of this drug, the user not only enhances his endurance, but also feels no pain. Certain Klingon Marine units are said to use this drug on suicide missions.

## Neural Paralyzer

This drug is identical to its Federation counterpart, which produces a death-like coma after an injection. Only sophisticated instruments can detect the difference between this coma and death. The coma will continue until a light stimulant is administered. If not administered soon enough, however, the victim will truly die.

## Pain-Blocking Drugs

While in effect, these drugs totally block all pain from wounds or other damage.

## Pain-Enhancing Agents

These drugs magnify a victim's pain.

## Sedatives

These drugs are identical to their Federation counterparts, producing relaxation, calming, or even unconsciousness. There are three general types: light, medium, and heavy. An overdose can produce death.

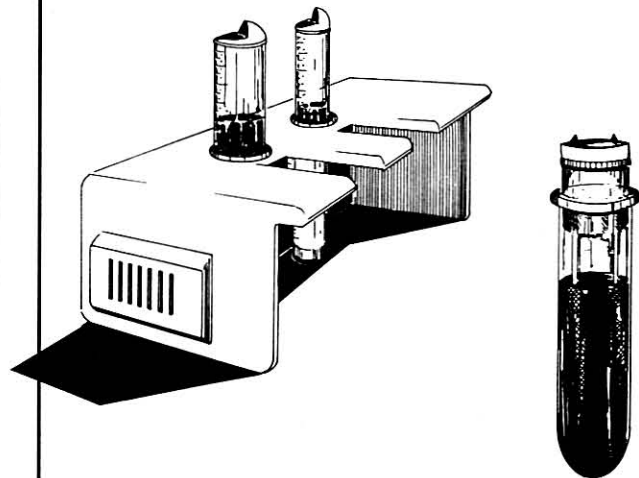

## Stimulants

These drugs are identical to their Federation counterparts, allowing an exhausted person to function without rest, functioning normally for a time. They may also temporarily revive an unconscious person. There are three types: light, medium, and heavy. Even a normal dose takes its toll, however, and an overdose may do severe body damage. Stimulants sometimes produce unusual side effect.

## Suggestibility Agents

These drugs make the victim extremely suggestible for a period lasting from one to ten hours. In many cases, the victim will believe whatever he is told. The drug *cannot* force a person to take an action he would not ordinarily take—killing a friend, for example, or betraying a trust. What it can do is trick the victim into carrying out such an action by making him believe, say, that the friend is really an enemy in disguise.

## Truth Drug

This drug impairs the victim's will to resist questioning. Under the drug's influence, the victim feels compelled to respond truthfully to any question posed. In many instances, however, the victim *may* be able to tell the truth without conveying any information. In those instances, the interrogator must word his question carefully. A second dose of the drug will not duplicate the effect.

## WEAPONS

Below are the types of weapons usually carried by Klingon naval or marine personnel. In addition, Klingons are known to carry concealed blades in their boots or up their sleeves.

### AGONIZER

Most officers aboard a ship carry an agonizer, including the Captain, First Officer, Security Officer, Medical Officer, and Marine Liaison. Used mostly for discipline and torture, this short, cylindrical device has a contact grid at one end, a finger-grip groove on the bottom, and a thumb-slide on top that controls intensity. (Agonizers are sometimes used to keep a 'frozen' limb alive enough to be useful.)

The agonizer is usually applied to a victim's left shoulder or upper chest, and can operate even through light clothing. Sliding the thumb-slide forward produces sensations ranging from mild discomfort to crippling pain or unbearable agony at the user's whim.

When an agonizer is applied, the victim cannot lose consciousness, as the device artificially bypasses this defense mechanism of the brain via direct neurological stimulation. Interestingly enough, the victim suffers no physical damage, although prolonged use can effectively short-circuit his nervous system, resulting in temporary or permanent paralysis and loss of feeling in affected limbs.

Agonizers are not viable as combat weapons, because they require direct and solid contact near a major nerve center to work properly. The resulting pain is not localized in the contact area, except at lower power settings.

Certain drugs available within the Federation can mask the agonizer's effect, but these drugs have serious side effects, including nervousness, irritability, increased burden on the heart and lungs, and memory loss. They are only available to undercover agents and other critical personnel trained to use them in an emergency. These same drugs also exist within the Klingon Empire, but it is highly illegal to produce, sell, use, or possess them. Hypnotic techniques or the mental disciplines known to Vulcans can block the agonizer effect, but among Humans, only high-level security agents have learned these techniques.

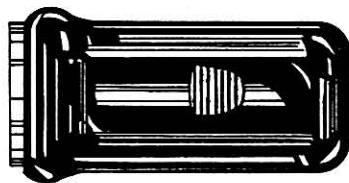
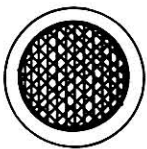

Sound does not travel in a vacuum, and so use of the term *sonic disruptor* is incorrect in most cases (and in *all* cases relating to ship's weaponry). Though early hand disruptors were indeed sonic-maser weapons, modern hand disruptors use focused microwaves, with late models able to suppress the target's molecular binding forces. They operate in the pulse mode, causing oscillating stress and contraction in the target.

Both types of weapon produce vibrations, heat, and noise. The Klingon term *vir dakaasei* means literally "the shake-it-till-it-falls-apart tool". (Note that in *Klingonaase*, there is no distinction between tools and weaponry.)

—An Informal Guide to the Klingon Empire

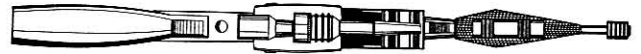
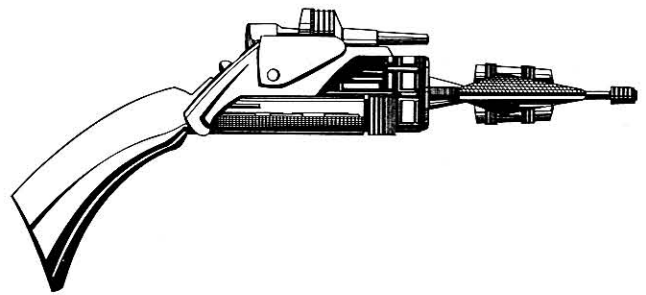

### HAND DISRUPTOR, MARK I

The Mark I hand disruptor is the first of its type used by Klingon soldiers. Also called the sonic disruptor, this weapon uses a tightly focused beam of high frequency sound. Klingons seldom use this model anymore. They still trade them to the Romulans and Orions, however, and Mark Is are even available on the black market in the Federation. For those who have never used the Mark I, it is a bit clumsy to handle. It is also harder to field repair. In this primitive design, the beam exciter cylinder at the base of the barrel must be shielded by small field grids on either side in order to keep the beam properly focused. If the weapon is dropped or handled roughly, these grids may be misaligned, resulting in less accuracy.

The Mark I disrupts and damages the cell structure of living organisms, but cannot disintegrate them. If fired at solid objects, it produces vibration and heat, either shattering or melting them. The exact result will depend upon the structure and materials of the target.

To operate any hand disruptor, the user must curl all four fingers around the hand-grip, and rest the thumb on the firing stud (located on the top of the grip) just behind the main body of the weapon. There is no trigger or trigger guard underneath the grip. The various power settings are adjusted by turning the front ring of the beam exciter cylinder.



### DISRUPTOR RIFLE, MARK I

Except for a larger power pack and longer barrel, the Mark I disruptor rifle is similar in design and principle to the Mark I hand disruptor. These variations allow the rifle greater capacity and range.

Because the disruptor rifle was developed after the Mark I hand disruptor, it lacks field grids on the beam exciter cylinder. The beam exciter cylinder is placed further down the barrel, and, of course, the barrel is longer. These two facts make the field grids unnecessary, and so the disruptor rifle is less delicate than its hand-held brother. In fact, it was this breakthrough in focusing technology that led to the development of the Mark II hand disruptor.

## HAND DISRUPTOR, MARK II

The Mark II hand disruptor uses a molecular debonding effect. Similar in function and operation to the Mark I, it can cause either cellular disruption, vibration, or heating effects in the target. If set on its highest power setting, the Mark II is capable of disintegrating a man-sized target. This setting is very wasteful of power, however, and not very effective at extreme ranges.

One of the major changes between the Mark I and the Mark II is the elimination of the clumsy and delicate field grids. There is no rifle version of the Mark II hand disruptor, as the Mark I rifle was still in use at the time it was developed.

## HAND DISRUPTOR, MARK III

With its greater range and power reserve, the Mark III hand disruptor is basically an improved version of the Mark II disruptor. The Mark III is slightly bulkier than the Mark II, but was designed with simplicity of manufacture and field repair in mind. It is also capable of the higher power disintegration setting of the Mark II.

The Mark III disruptor rifle is actually the same weapon as the hand disruptor. Klingon weaponsmiths noted the use of the power cradle that turned Star Fleet's hand-held Phaser I into the pistol-gripped Phaser II, and decided to use the same principle to convert the hand disruptor into the disruptor rifle.

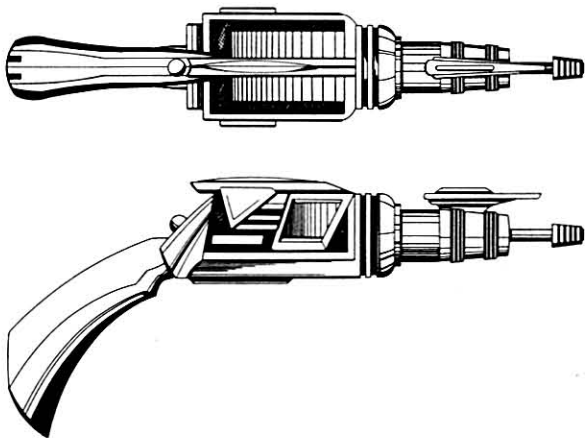

To make the conversion, the user has only to snap an extension stock into two guide slots of the hand-grip. The extension stock contains an extra power supply to extend the power reserves of the disruptor. Also contained in a small compartment in the extension stock is a longer barrel. The short hand disruptor barrel can be easily removed from the beam exciter cylinder, and the longer version inserted in its place. This longer barrel increases the usable range and accuracy of the disruptor. The longer barrel can be used without the extension stock, but this affects the balance of the weapon and makes it more difficult to handle with one hand.

## DISRUPTOR RECHARGE PACK

Mark I, II, and III hand disruptors use the same type of power pack, and so do Mark I and Mark III disruptor rifles. Hand disruptor power packs cannot be interchanged with disruptor rifle power packs, however. Disruptor power packs take approximately 20 minutes to recharge.

## GRENADE, DIFFUSION

Often used by Klingon Marines, this grenade releases a cloud of reflective/absorbing particles that reduce the effectiveness of Federation phasers and Romulan beam weapons.

## GRENADE, SONIC

Available in cases of six, this grenade causes sonic disruption damage in a localized area.

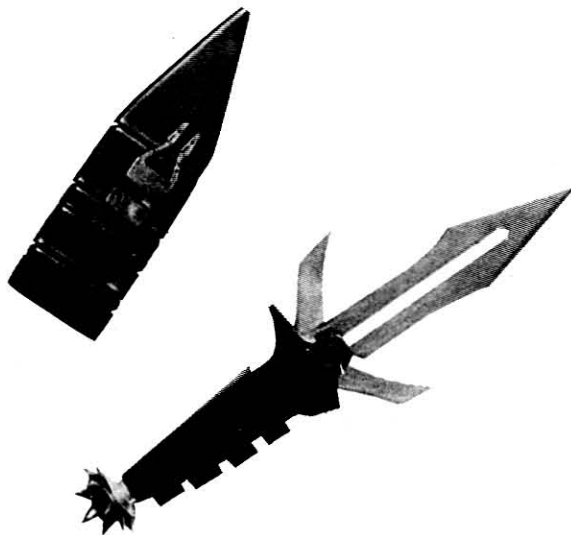

## LEV'EK, THREE-LOBED KNIFE

A favorite hand weapon of many Klingon soldiers is the *lev'ek*, which translates literally as "three-knife". The *lev'ek* has a long central knife blade with two extra, spring-loaded blades that snap out from it at the touch of a button.

Originally, early Klingons maintained a practice of keeping three separate knives in a single scabbard. Thus, a knife fighter could lose or throw his weapon and still remain armed. In time, someone came up with the idea of putting those three knives together into one unit. This three-lobed blade did quite a bit more damage to its victim, and had the advantage of acting as a shield to stop an opponent's blade. Later, the two outer blades were made smaller, reducing the damage done by the knife, but retaining the shielding ability. This newer version could also be balanced for throwing, while the earlier version could not.

During the Klingon age of invention, someone discovered that the outer blades of the popular three-lobed knife could be spring-loaded. When first used in combat, the user's opponent is reported to have said, "Your *lev'ek* is crippled"—just before he died on the spring-loaded blades. Even though the use of the *lev'ek* predates space travel and energy weapons, it still remains a very popular weapon.

## SONIC MORTAR

Similar in effect to sonic grenades, a sonic mortar acts as an indirect fire weapon to deliver sonic projectiles.

## ZHAL STA

This monofilament sword slices through living tissue, causing widespread cell damage, agonizing pain, and, almost invariably, death. If not used with extreme care, the *Zhal Sta* will cause as much injury to its wielder as to its target. It is intended more for interrogation than for melee situations.

## SHIPBOARD SYSTEMS

Like Federation vessels, the starships of the Imperial Klingon Navy have bridges, armories, engineering sections, and so forth. Klingon shipboard systems that differ from their Federation counterparts are described below.

### AGONIZER BOOTH

The agonizer booth is a shipboard interrogation device that is a larger variation of the hand-held Klingon agonizer. It is a small, enclosed space with a seat inside and many agonizer pads strategically located in the seat. The agonizer booth has much subtler controls, and is effective during torture and interrogation.

### COMPUTER, SHIPBOARD

Klingon vessels do not use one, large, artificially intelligent master computer as do Federation ships, but instead parcel out the tasks to many smaller systems. These separate units can communicate and transmit data to each other, but are functionally separate. The reason for this design is security. A decentralized computer is harder to knock out in battle and is also more difficult to sabotage. Unfortunately, this means that a Klingon ship requires a skeleton crew roughly twice as large as a Federation ship's.

Klingons do not overlay their computers with artificial intelligence or personalities, preferring their machines to act like machines.

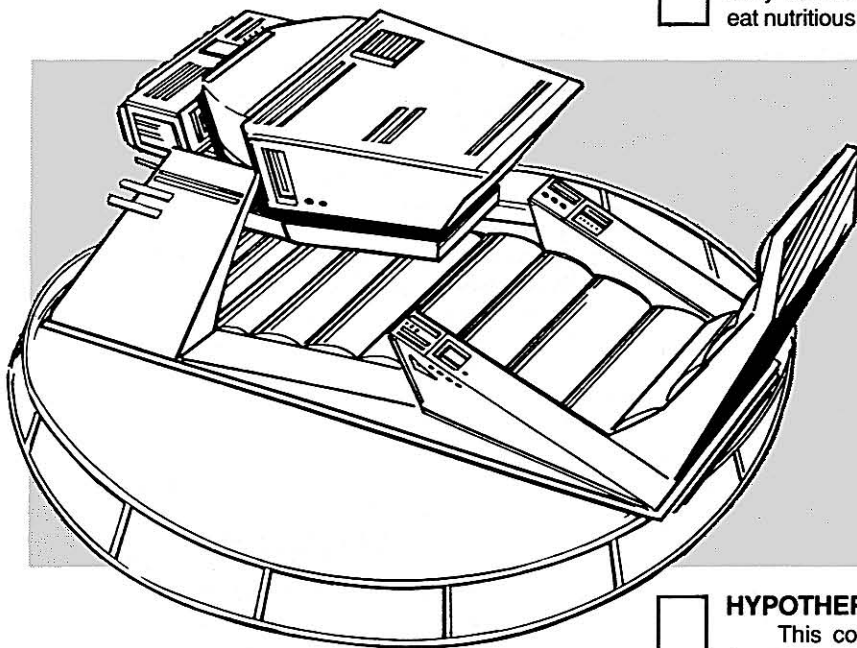

### DETENTION FACILITIES

Although some of the newer Klingon vessels have adopted Federation-style forcefield doors to restrain their prisoners, most brig cells still use standard, electronically locking hullmetal doors. Most Klingons feel that any door that is totally transparent is too easily removed or bypassed.

### DISRUPTORS

The Klingons' primary ship-to-ship weapons are shipboard disruptors. These weapons use a pulsed waveform to suppress the molecular binding forces in the target. This creates oscillating stress and contraction of the target, which in turn produces vibration and heating. The effect causes massive disruption of nervous tissue in living things, and can kill right through the hulls of the target ship.

Disruptor technology is not as subtle or versatile as phaser technology, but Klingons continue to use it (even though phaser technology is known to them) because disruptors are less of a power drain, easier to maintain, and less delicate than phasers. Disruptors also do not require the use of dangerous coolant gases. A further possibility is that the Klingon psychology prefers the more devastating, less humane and controlled weapon.

Though disruptor fire from a ship can be directed against ground targets, planetary atmosphere reduces the disruptor effect and lowers the weapon's accuracy. Klingon commanders, however, use such tactics to induce terror in a population or to wipe out large areas. For these purposes, the lack of accuracy is not much of a handicap.

### FOOD SYNTHESIZERS

Klingon food synthesizer technology is as advanced as the Federation's, but Klingons rarely bother to utilize it for most ship personnel. The top echelon does have small, highly versatile synthesizers operated by those they trust. Lower-rank officers have fewer choices, but still do eat fairly well. Enlisted personnel and combat troops generally eat nutritious but unappealing yeast products.

### HYPOTHERMIA CAPSULE

This coffin-shaped device is a cold-sleep capsule for the transport of Marine troops to and from an engagement. Each unit contains the necessary equipment for maintaining the life of its inhabitant, but has no external readouts. At the foot end is a data cart slot. This can be used either to record the medical data onto a data cart (data from 25 capsules fits onto one cart) or can be plugged into a computer/recorder directly with a universal cable.

It should be noted that approximately one of every 25 persons placed in Klingon cold sleep will not survive the waking process. [NOTE: The editor discounts the rumor that Klingon medical personnel place wagers on any individual's chances of surviving the process.]

## INSPIRATIONAL MEDIA

This is a polite term for indoctrination and propaganda, to which every Klingon is exposed nearly every day of his life. Shipboard personnel are required to view inspirational films and presentations on a regular basis, usually as a group. Most ships have inspirational media rooms or other gathering halls for this purpose.

## INTRUDER DEFENSE SYSTEMS

Should enemy forces board a Klingon vessel, command personnel can activate a series of computer programs to combat the intruders. The Captain or his Executive Officer normally activate these programs. In their absence, however, any department head can do so. Due to the expense of these systems, however, most Klingon vessels are not so equipped. Below are a few of the defense system options.

### Security Bulkheads

Activating the security bulkheads drops emergency blast doors at all corridor junctions. Similar blast doors are automatically employed around the ship's armories, engineering, and life-support centers. These are used to contain or channel the threat of an attack force (or mutiny) away from critical points aboard ship. Once in place, each blast door can absorb 200 points of damage before being rendered ineffective.

### Turbolift Shutdown

This system may slow down the deployment of hostile forces by depriving them of swift lateral and vertical movement throughout the ship.

### Gravity and Life-Support Shutdown

Unless fully protected in environmental gear, personnel in affected areas will immediately experience weightlessness and the loss of life-support functions.

### Marine Contingent Revival

In the event of emergency, the ship's marine contingent can be revived en masse from their cryogenic sleep capsules. This provides the Captain with a large number of reinforcements in a short period of time.

### Explosive Decompression

The decompression of selected areas of the ship will effectively deter any attackers (and friendly forces) not equipped with environmental suits. A valve in the ship's hull will open, exposing the area to the vacuum of space. Those who do not immediately asphyxiate better grab onto a fixed object, or they may find themselves sucked into the void.

### Nerve Gas Agents

In an extreme case, the ship's Captain may introduce nerve gas agents throughout the ship, one deck level at a time. Anyone not protected by filter masks or environmental gear will fall victim to the gas in 60 seconds. Note that the ship's Captain is the only one who knows the special computer code to activate the gas.

### Boom Separation

As a last resort, the ship's command pod and boom may be separated from the rest of the ship. Once separated, the command section cannot be rejoined with the ship's main hull, short of an overhaul in drydock. A severed command section has insufficient power to arm weapons or to engage in warp speed, although it can travel up to .82 sublight.

## SHIP'S LOGS

Though Klingon officers keep log entries, they are not above doctoring the entries to save face. For this reason, it is not uncommon for most high-level officers to also keep secret personal logs. Remember, too, that Imperial Security maintains built-in recorders on most ships. Rumor tells that some Captains have found and doctored these as well as the regular logs, but no one can be sure there is not still *another* hidden recorder elsewhere. Such is life in the Empire.

## SURVEILLANCE FACILITIES

Surveillance facilities for monitoring all areas of a ship exist aboard all but the smallest Klingon vessels. It is usually impossible to devote enough manpower and computer power to monitor all locations at once, and so only sensitive areas and trouble spots are scanned constantly. All other areas are monitored periodically on a random basis.

## TARGET DRONES

Many larger Klingon vessels carry robot drones that are used mostly as targets for ship combat practice and as probes. Drones are capable of only sublight speeds, and are *not* normally suitable for use as weapons. They can be fitted with small warheads if necessary, however. Most ships can launch one drone every ten seconds. Drones launched while a ship is running at warp speed are automatically destroyed by the stresses involved.

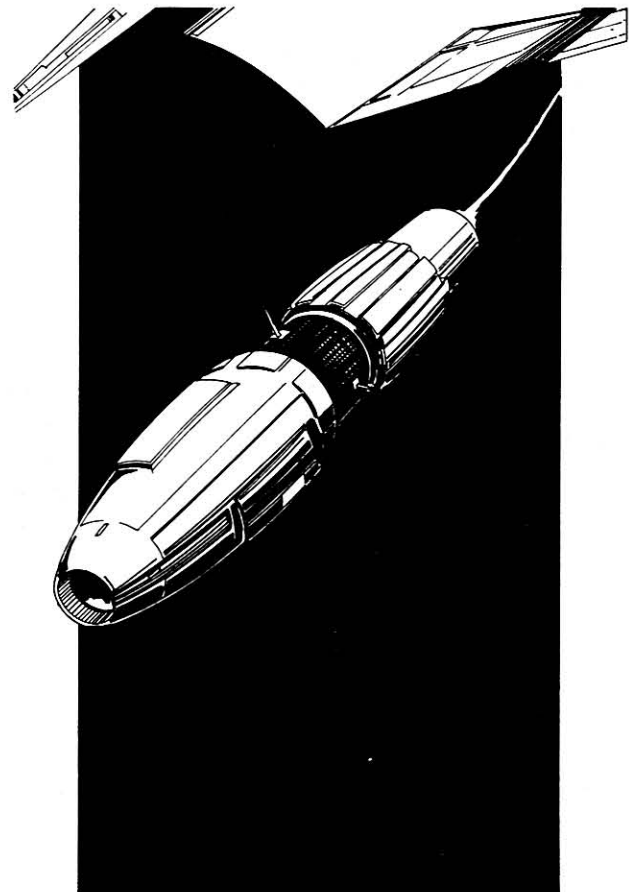

## TRANSPORTER

Although the Klingon version of the transporter is similar in range and capability to the standard Federation model, the similarity ends there. Klingon transporters operate silently, which is a distinct advantage in boarding and invasion actions. Although the Federation experimented with silent, faster transporters, most of these ended in disastrous failure. Federation scientists discontinued this line of investigation when they discovered that the heavier shielding required in newer transporters actually increased the rate of failure through interference with the scanning waves. The Klingons, on the other hand, consider such loss of life to be only a minor consideration.

The Klingons install huge mass transporters on troop ships, which allows large numbers of troops to be beamed at once. Naturally, such mass transports draw enormous amounts of power, and can only be used if all shields and weapons are unpowered. A commander will use them only after an enemy orbital station is secured and all orbital enemies have been eliminated. Of course, between the normal failure of the Klingon transporter and the massive power drain during transport, about 2 percent of all troops are lost due to scanning or reassembly failure. The Empire considers these to be acceptable loss levels.

Top-level Klingon officers (ship's Captains or those highly placed in their lines) each have a *transporteer*, or transport officer, assigned to them. It is this officer's responsibility to check all transporter settings and equipment to ensure the safety of his superior officer. Because the officer must trust his transporteer absolutely, this person is often a member of a *kuve* race who can have no ambitions of his own. If the transporteer is *kuve*, he is not actually an officer himself, but carries the full authority of his commander in matters relating to that officer's safety during transport. The transporteer is usually also a trained shuttle pilot.

Though the Klingon transporter operates on the same scanning and reassembly principle as the Federation device, it is silent in operation. This is because the Federation transporter uses a "supercarrier wave", in addition to the main signal. The two waves heterodyne at the assembly point, overdetermining the signal and producing parasitic noise effects. Although the supercarrier does not eliminate transporter accidents, it does make it impossible for transporter accidents such as signal dropout to occur. The Klingons consider this to be a typically excessive precaution. Klingons also use the transporter to place boarding parties. Silence is a virtue for such purposes. It should be noted that the Empire developed and deployed transporters about 30 years before the Federation did, probably because Klingons do not have the strict Federation restrictions on experimentation with living organisms.

—An Informal Guide to the Klingon Empire

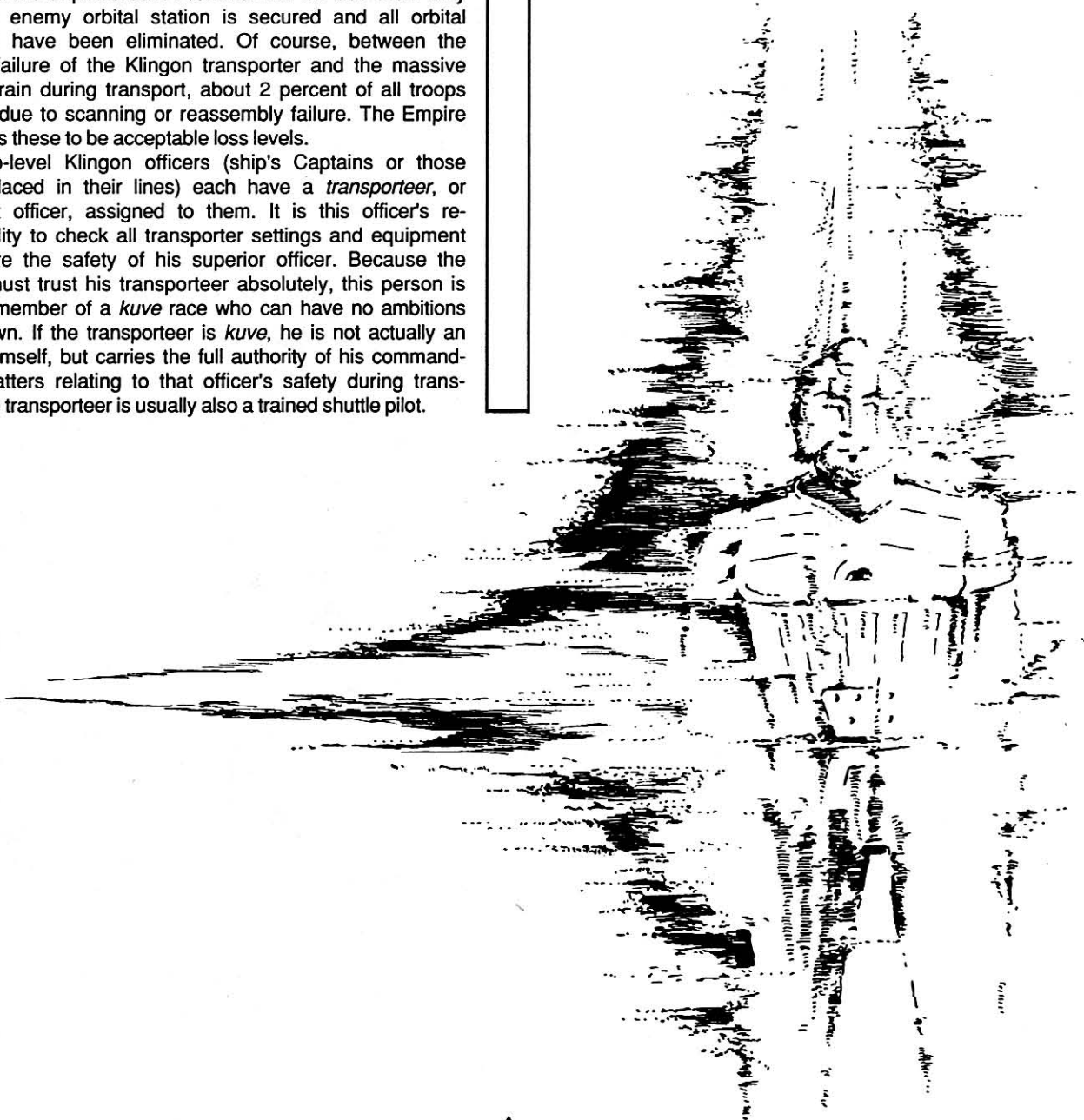

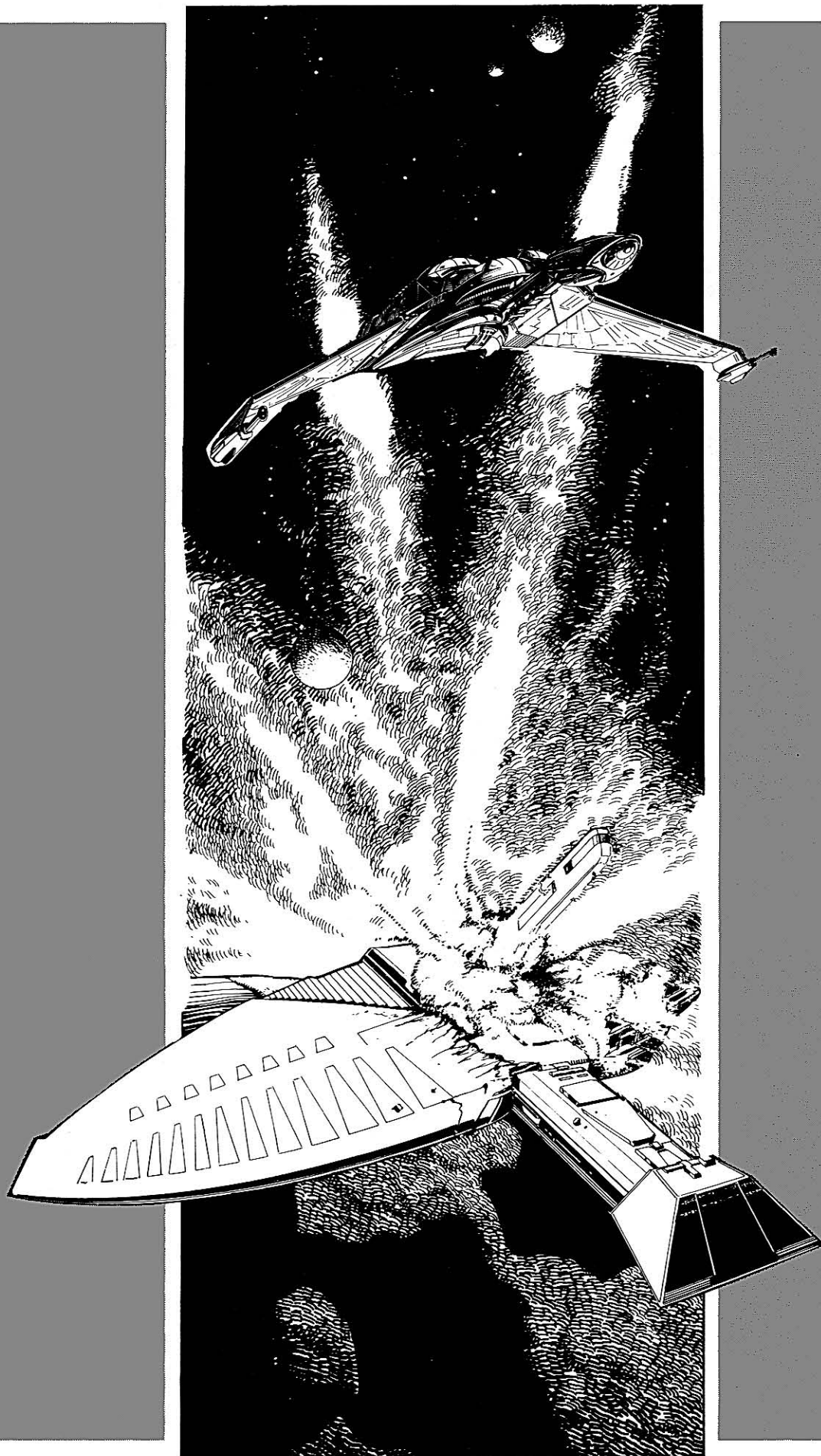

CRESTS OF MAJOR KLINGON LINES



DREXA

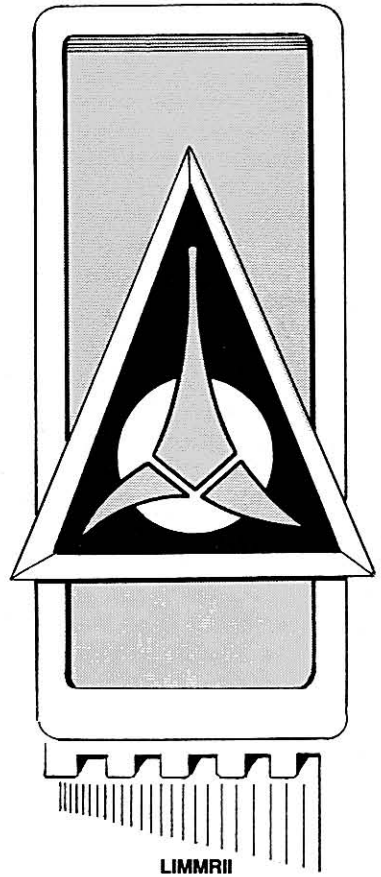

LIMMRII

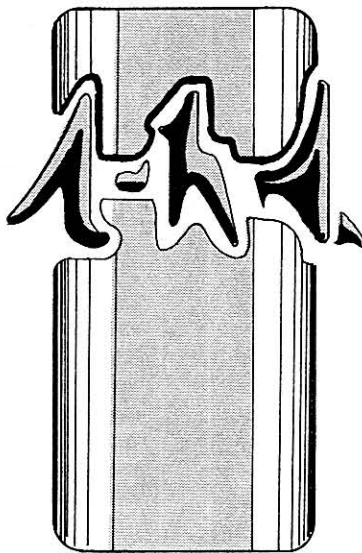

SIMPARRI

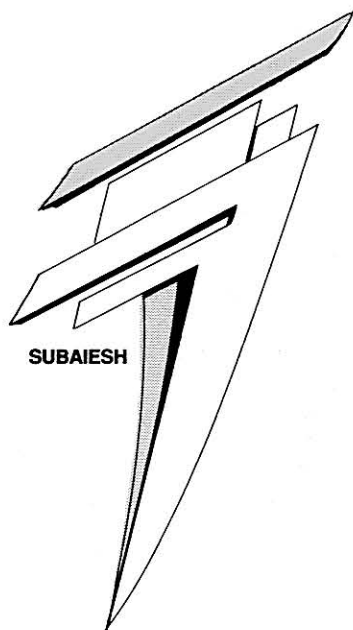

SUBAIESH



URUSSIG

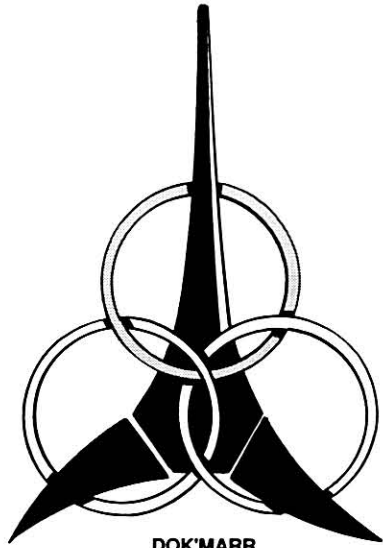

DOK'MARR

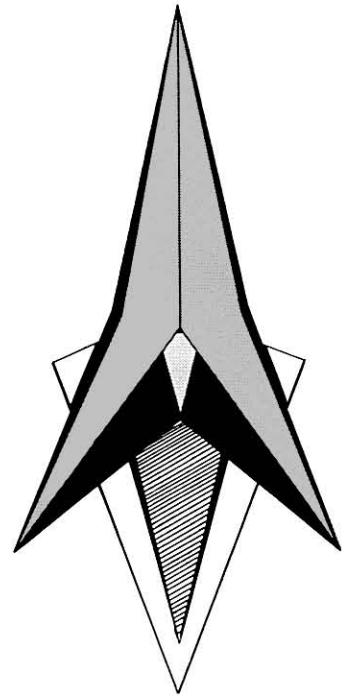

SOLAZARN

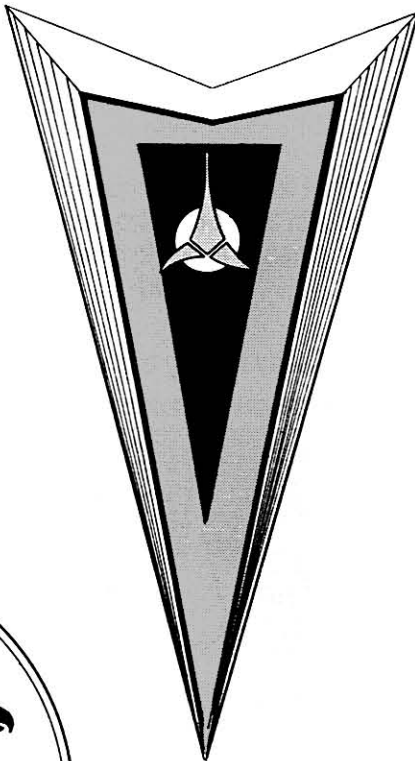

JURISS



PALLARA

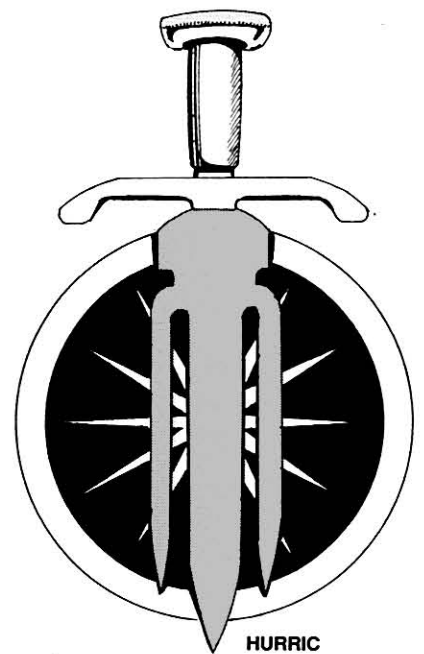

HURRIC

## THE KLINGON OATH OF EMPIRE

Beneath the stars that drip with blood  
I stand, defiant and alone. I am here,  
My Emperor. Call on me, I beg of Thee.  
I was nothing before this day and nothing  
Shall I remain if I cannot serve Thee now.

Pain and suffering are my just rewards.  
Do with me as serves Thee best. It matters  
Not that I survive, only that which I  
Defend.

Forfeit of life, but not of honor, in Thy  
Cause, death at last is welcome. I am here,  
My Emperor, ready at last to be an instrument  
Of Thy will.

Ready to obey and die.

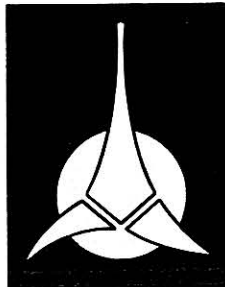



# T·H·E KLINGONS

STAR · FLEET · INTELLIGENCE · MANUAL

STAR TREK is a Registered Trademark of Paramount Pictures Corporation.  
STAR TREK: The Role Playing Game is published by FASA Corporation under license from Paramount Pictures Corporation, the trademark owner. Copyright © 1987 Paramount Pictures Corporation.  
All Rights Reserved. Printed in the United States of America.